

Eurasiatica

Quaderni di studi su Balcani, Anatolia, Iran,  
Caucaso e Asia Centrale 5

---

# **Borders**

## Itineraries on the Edges of Iran

edited by  
Stefano Pellò



**Edizioni**  
Ca' Foscari

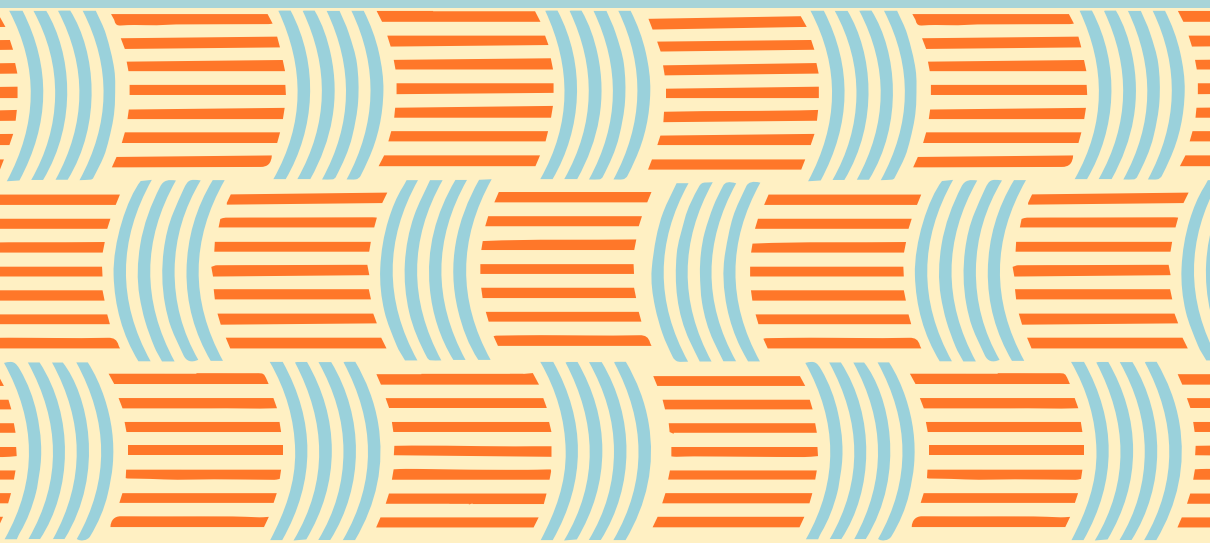





Borders

## **Eurasiatica**

Quaderni di studi  
su Balcani, Anatolia, Iran,  
Caucaso e Asia Centrale

Collana diretta da  
Aldo Ferrari

5



**Edizioni**  
Ca' Foscari

# **Eurasiatica**

## Quaderni di studi su Balcani, Anatolia, Iran, Caucaso e Asia Centrale

### **Direttore**

Aldo Ferrari (Università Ca' Foscari Venezia, Italia)

### **Comitato scientifico**

Gianfranco Giraudò (Università Ca' Foscari Venezia, Italia)

Aleksander Naumow (Università Ca' Foscari Venezia, Italia)

Antonio Panaino (Università di Bologna, Italia)

Valeria Fiorani Piacentini (Università Cattolica del Sacro Cuore, Milano, Italia)

Adriano Rossi (Università degli Studi di Napoli «L'Orientale», Italia)

Boghos Levon Zekiyán (Università Ca' Foscari Venezia, Italia)

### **Comitato di redazione**

Alessandra Andolfo (Università Ca' Foscari Venezia, Italia) Giampiero Bellingeri (Università Ca' Foscari Venezia, Italia) Giorgio Comai (Dublin City University, Ireland) Simone Cristoforetti (Università Ca' Foscari Venezia, Italia) Erica Ianiro (Università Ca' Foscari Venezia, Italia) Gianclaudio Macchiarella † (Università Ca' Foscari Venezia, Italia) Stefano Pellò (Università Ca' Foscari Venezia, Italia) Gaga Shurgaia (Università Ca' Foscari Venezia, Italia) Vittorio Tomelleri (Università degli Studi di Macerata, Italia)

### **Direzione e redazione**

Dipartimento di Studi sull'Asia e sull'Africa Mediterranea

Università Ca' Foscari Venezia

Ca' Cappello, San Polo 2035

30125 Venezia

eurasiatica@unive.it

# **Borders**

## Itineraries on the Edges of Iran

edited by  
Stefano Pellò

Venezia

**Edizioni Ca' Foscari** - Digital Publishing

2016

Borders. Itineraries on the Edges of Iran  
Stefano Pellò (edited by)

© 2016 Stefano Pellò for the text

© 2016 Edizioni Ca' Foscari - Digital Publishing for the present edition

Qualunque parte di questa pubblicazione può essere riprodotta, memorizzata in un sistema di recupero dati o trasmessa in qualsiasi forma o con qualsiasi mezzo, elettronico o meccanico, senza autorizzazione, a condizione che se ne citi la fonte.

Any part of this publication may be reproduced, stored in a retrieval system, or transmitted in any form or by any means without permission provided that the source is fully credited.

Edizioni Ca' Foscari - Digital Publishing  
Università Ca' Foscari Venezia  
Dorsoduro 1686  
30123 Venezia  
<http://edizionicafoscari.unive.it/>  
[ecf@unive.it](mailto:ecf@unive.it)

1a edizione agosto 2016 | 1st edition August 2016

ISBN 978-88-6969-100-3 [ebook]

ISBN 978-88-6969-101-0 [print]

The poem quoted at the beginning of this volume is taken from 'Abbās Kiārostami, *Hamrāh bā bād*, Tehrān: Nashr-e Honar-e Irān, 1378/1999-2000, p. 221. Translation by Stefano Pellò.



Certificazione scientifica delle Opere pubblicate da Edizioni Ca' Foscari - Digital Publishing: tutti i saggi pubblicati hanno ottenuto il parere favorevole da parte di valutatori esperti della materia, attraverso un processo di revisione anonima sotto la responsabilità del Comitato scientifico della collana. La valutazione è stata condotta in aderenza ai criteri scientifici ed editoriali di Edizioni Ca' Foscari.

Scientific certification of the works published by Edizioni Ca' Foscari - Digital Publishing: all essays published in this volume have received a favourable opinion by subject-matter experts, through an anonymous peer review process under the responsibility of the Scientific Committee of the series. The evaluations were conducted in adherence to the scientific and editorial criteria established by Edizioni Ca' Foscari.

Borders. Itineraries on the Edges of Iran / Stefano Pellò — 1. ed. — Venezia: Edizioni Ca' Foscari - Digital Publishing, 2016. — 410 pp.; 23 cm. — (Eurasistica; 5). — ISBN 978-88-6969-100-3.

<http://edizionicafoscari.unive.it/it/edizioni/libri/978-88-6969-101-0/>

DOI 10.14277/978-88-6969-100-3

## **Borders**

Itineraries on the Edges of Iran

edited by Stefano Pellò

## **Contents**

### **Introduction**

Stefano Pellò

11

### 0 CROSSINGS

#### **Sui confini della poesia**

Gianroberto Scarcia

25

### 1 A MARCHLAND OF WORDS

#### **Additional Considerations about Ved. *Síndhu-*, Av. *Hiṇdu-/Həṇdu-***

Antonio Panaino

41

#### **Arabic *ḥadd* in Iranian**

##### **Notes on Some Cases of Grammaticalization**

Ela Filippone

53

### 2 INSPECTING PERIMETERS

#### **If these Walls Could Speak**

##### **The Barrier of Alexander, Wall of Darband and Other Defensive Moats**

Touraj Daryaee

79

#### **Cycles and Circumferences**

##### **The Tower of Gonbad-e Kāvus as a Time-measuring Monument**

Simone Cristoforetti

89

### 3 ICONOGRAPHY ON A THRESHOLD

#### **Flying over Boundaries**

##### **Auspicious Birds in Sino-Sogdian Funerary Art**

Matteo Compareti

119

#### **Vague Traits**

##### **Strategy and Ambiguities in the Decorative Programme of the Aḥmad Šāh I Bahmanī Mausoleum**

Sara Mondini

155

### 4 LINES OF TRANSITION

#### **Kashmir and the Mughal Fad of Persian Pastoral Poetry**

Sunil Sharma

183

#### **A Linguistic Conversion**

##### **Mirzā Muḥammad Ḥasan Qatīl and the Varieties of Persian (ca. 1790)**

Stefano Pellò

203

### 5 ON THE LIMES

#### **A World In-between**

##### **The Pre-Islamic Cultures of the Hindu Kush**

Augusto S. Cacopardo

243

#### **Transregional Intoxications**

##### **Wine in Buddhist Gandhara and Kafiristan**

Max Klimburg

271

### 6 IDENTITY AND THE OTHERS

#### **Marginalia on the Idea of Boundary and the Discourse on Identity in Iran**

Biancamaria Scarcia Amoretti

305

#### **Perceptions and Treatments of the Close Other in Northern Iran**

Christian Bromberger

321

## 7 MIRRORS AND BEYOND

### **Certified Copy**

#### **The Thin Line between Original and Original**

Marco Dalla Gassa

333

### **Crossing Borders**

#### **Iranian Landscapes as Visual Prototypes around the World**

Riccardo Zipoli

353





نه خاور	No East
نه باختر	No West
نه شمال	No North
نه جنوب	No South
همين جا كه من ايستاده ام	Just this place where I am standing

(Abbas Kiarostami, 1940-2016)



## Borders

Itineraries on the Edges of Iran

edited by Stefano Pellò

## Introduction

Stefano Pellò

Persian literary culture has made an extensive use of the ubiquitous metaphorical image of the *safīna*, the ‘ship’, or, perhaps better for what concerns us here, the ‘ark’, at least since the Ghaznavid times, when, for instance, the poet Manūchihri Dāmghānī (eleventh century) compared his horse «running in the night» to a «vessel (*safīna*) crossing the gulf».<sup>1</sup> An Arabic loanword with an illustrious history in the Qur’ān (for instance, to indicate Noah’s Ark in 29:15), the term, which in the Islamicate world identifies, among other things, the constellation known in Latin as Argo Navis, has been commonly employed in Persian to define a book containing a selected anthology (of poems, biographies, or other textual material). This collection of essays, which is presented here as the fifth issue of a recently reborn project significantly called *Eurasiatica*, was first imagined as a Venetian *safīna* (or better *safīné*), proudly invoking the truly cosmopolitan world of connections of a faded Adriatic *koine* extending to the Bosphorus. It now stands as the first volume of this new *Eurasiatica* entirely devoted to the vast territories of Iranian culture, which we aim at understanding in the widest sense possible – extending without interruption over the layered spaces of *Ērān ud Anērān*, to play with a sometimes abused Middle Persian expression<sup>2</sup> – and of course including what is now usually called in English the ‘Persianate’, in an open chronological perspective.

As a matter of fact, openness, inclusivity, and a clearly stated emphasis on deep and wide-ranging interactions were among the main characteristics of the first *Eurasiatica*: a series which saw its first volume published in 1986 (a book by Irina Semenko on Osip Mandel’štam’s poetics) and the last one in 2011, after no less than eighty-four issues, which become more than one hundred if we include the twenty-three volumes of the precursor *Quaderni del seminario di iranistica, uralo-altaistica e caucasologia*

1 Manūchihri Dāmghānī, *Dīvān-i Manūchihri-yi Dāmghānī*. Ed. by Muḥammad Dabīrsiyāqī. Tīhrān: Zavvār, 1370 (1991-2), p. 83.

2 Interesting observations can be found in Dick Davis, «Iran and *Aniran*: The Shaping of a Legend». In: Amanat, Abbas; Vejdani, Farzin (eds.), *Iran Facing Others: Identity Boundaries in a Historical Perspective*. New York: Palgrave Macmillan, 2012, pp. 37-48.

dell'Università degli studi di Venezia, begun in 1979.<sup>3</sup> It was the expression of an academic department (the now suppressed *Dipartimento di Studi Eurasiatici* of the University Ca' Foscari of Venice), which, though small and local, was nonetheless rooted in a cultural project rather than in ministerial decrees. Its aim was not so much, in Dipesh Chakrabarty's fashionable terms, to provincialize Europe, but to philologically explore continuities, interdependences and connections between Palermo, Sarajevo, Kashghar and Agra, including of course the significant *place* of Venice, against any fetishization of particularism. To find an up-to-date parallel, the methodology was, perhaps, more reminiscent of that of an historian of connections such as Sanjay Subrahmanyam, especially if we look at the tendency to deconstruct the provincial *habitus* of producing irreducible antitheses – with no temptation whatsoever, of course, for the colonising mantras of liberal imperialist world-pedagogies and their oxymoronic rhetorics of democratisation.

Among the many relevant volumes included in that series, I should like to mention here, for the revealing geographies involved, *L'Italia nel Kitab-i bahriyye di Piri Reis* (1990), a posthumous masterwork by the main Italian forerunner of the studies on the Persianate and Islamicate cosmopolis, Alessandro Bausani, devoted to the representation of Italy by the well-known sixteenth century Ottoman admiral and world-cartographer Piri Re'is. But one can also refer, in terms of transregional interactions, to the volumes of *Eurasiatica* by some of the best Italian and international authorities on Hebrew studies (such as Giulio Busi), Russian studies (such as Sergio Molinari) and Armenian studies (such as Boghos Levon Zekiyani). Most of these works were written in Italian, before the official establishment of the curious hegemonic 'cosmopolis' of the present day, where, with the growing of an often formulaic enthusiasm for anything multilingual, we witness the paradoxical tendency to study it from the proliferating monolingual perspective of the Anglosphere.

In an increasingly homogenized world where the apparently contradictory – but obviously strategic – construction of violent identitarian boundaries has been steadily underpinning the neocolonial policies of the postfordist market – from the disintegration of Yugoslavia to the *inventio* of the Sunni-Shia rift in Syria and Iraq – devoting this volume to the liminal theme of (Iran on) the borders seemed an appropriate way to celebrate the thirty years of a programmatically borderless and anti-purist series such as the old (and, hopefully, the new) *Eurasiatica*. This collection of essays has not been conceived as an organic treatment on the borders and thresholds of the transforming 'idea of Iran' (the homonymous influential 1989 book by

---

3 A complete list of the volumes of the old *Eurasiatica* series can be found at [http://www.unive.it/nqcontent.cfm?a\\_id=191341](http://www.unive.it/nqcontent.cfm?a_id=191341) (2016-07-13).

Gherardo Gnoli comes immediately to mind, as do some more recent contributions such as those by Firoozeh Kashani-Sabet, Mohamad Tavakoli-Targhi, Carlo Cereti, Abbas Amanat, Farzin Vejdani, Kamran Scott Aghaie and Afshin Marashi, to mention only a few). It contains, instead, a series of itineraries exploring several heterogeneous borderlands (geographic and conceptual), starting from plural, competing and coexisting ideas of Iran. To bring up a key concept of Jean-Loup Amselle's anthropology, the attempt is to look for connections (*branchements*) in a context of frontier-identities which necessarily imply heterogeneity and difference.<sup>4</sup> With an eye to the structuralism of the school of Tartu-Moscow – it has been Jurij Michajlovič Lotman, after all, to describe the border as the locus where cultural innovation is produced<sup>5</sup> – one is even tempted to suggest, using the language of classical Persian poetics, that the 'border' (threshold, limit, boundary, etc.) plays here the role of a *radīf*, the refrain (a theme-word, or true *title*, indeed) at the end of every line of a poem. In Persian literary culture, after all, the 'threshold' is a metaphorical liminal place which marks the inaccessibility of a mobile horizon. A closed door, a house not to be found or an impassable stretch of road, the threshold flags, at the same time, the paradoxical necessity of the research itself, multiplied through obsessive acts of unveiling and the awareness of the existence of infinite other layers to be unveiled. The stereotypical image of the limit, the margin, the place of passage which becomes a place of stay (the lover living on the beloved threshold, for instance) is explored by the Persian poetical world through recursive processes of conceptual creativity. These are based on the author's ability to refer to the repertoire provided by tradition (by establishing unexpected new 'rhizomatic' connections, to use Gilles Deleuze and Félix Guattari's well-known expression). Against this background, it is interesting to observe that the threshold (or the margin), a symbolic as much as pragmatic figure already explored in its porous and undetermined sense in the homonymous work by Gérard Genette, provides an array of different accesses to the circuits of meaning.

The fourteen essays of this Venetian *safiné* sailing through such multifaceted thresholds, organized in pairs, enjoy the honour of being preceded by an Italian preamble 'on the borders of poetry' (and of translation, Orientalism, and the preventive censorship of language control) by Gianroberto Scarcia, the founder of the Venetian school of Iranian studies and the promoter of the first *Eurasiatica* series. The chapters of the first section, penned by two of the most authoritative Italian scholars in the field of

4 See in particular Jean-Loup Amselle, *Branchements: Anthropologie de l'universalité des cultures*. Paris, Flammarion, 2001.

5 I think here especially of Jurij M. Lotman, «Ponjatje granicy». In: Lotman, Jurij M., *Semiosfera*, Sankt-Peterburg, Iskustvo-SPb, 2001, pp. 257-268.

Iranian studies, explore some crucial linguistic issues on the theme of the border, somehow setting the tone for the following sections. The paper by Antonio Panaino, focused on the Avestan ecology of the key stem *həṇdu-/hiṇdu-* (O.P. *hi<sup>n</sup>du*), revolves around the polysemic features of a name for ‘frontier’ which would later come to define the geographical notion of ‘India’. Moving from Paul Thieme’s well-known observations on the most probable etymology of Vedic *Síndhu-*, to be connected to *\*sindhú-* ‘warding off, keeping away’ and thus to be understood primarily as ‘natural frontier’, Panaino reconstructs a hitherto unexplored chronology for the semantic flowering of this loanword (or, as Thieme preferred to say, Iranian adaptation of an Indo-Aryan term) in Avestan literature. In particular, by re-examining a representative set of sources, the author shows how, in the oldest parts of the Avesta, the stem *həṇdu-/hiṇdu-* retains the original meaning of ‘natural frontier’, thus rejecting the teleological interpretation of late nineteenth and early twentieth century scholars such as Christian Bartholomae, who saw in *həṇdu-/hiṇdu-* an already given geographical idea of ‘India’. Equally noteworthy, as far as the ancient perception of the North-Western regions of the Indian Subcontinent and the connected notion of limit-frontier is concerned, is Panaino’s discussion of the *Hapta.həṇdu-* as the ‘Land of the Seven Rivers’. Moving from Gherardo Gnoli’s anti-essentialist remarks on the absence of any ‘reason to consider the correspondence between *Hapta.həṇdu* and *Saptá Síndhavas* as based on a common ancestral mythical geography’, Panaino not only shows the nuances of later Zoroastrian interpretations (among other sources, he masterly draws on al-Bīrūnī), but also hints to a possible fascinating connection of the astronomical topology of the Avestan constellation of the *haptōiriṅga* – ‘The seven signs’ (cf. New Persian *haft awrang*), with the geographical borderland of the *Hapta.həṇdu* – through the parallel with the ‘seven climates’ of the world.

Juxtaposed to Antonio Panaino’s investigation of such a symbolic linguistic threshold in the Old Iranian Avestan environment is the study by Ela Filippone, which deals with the grammaticalization of an Arabic loanword, *ḥadd*, in Iranian languages, providing a richly documented and indeed groundbreaking exploration of the rugged and multi-faceted territories of New Iranian dialectology. After having clarified the highly polysemic nature of *ḥadd* in Arabic (knife-edge, edge, border, limit, inhibition, restraint, ordinance, partition, etc.), Filippone underlines the geographical and political meaning (especially in the plural *ḥudūd*) of *ḥadd* as ‘the limit of anything’, and, most cogently for what concerns us here, as a ‘frontier zone enveloping a central core’ (quoting Ralph Brauer). This polysemy, as the author argues, is preserved beyond the borders of Arabic, in the languages of the Islamicate cultural sphere where it has found a place as a loanword, from Turkish to Malay. Particularly interesting is an observation that Filippone makes at the beginning of her paper: ‘The notion of limit conveyed by Ar.

*ḥadd'*, she writes, 'favoured semantic bleaching and context generalization'. As a matter of fact, from her thorough analysis it appears clear that the range of use (chronological as well as geographical) of *ḥadd* along the porous contours of the Iranian languages is multifarious, far-reaching and continuous. As Filippone brilliantly – albeit cautiously – suggests in the conclusive remarks, one might even 'assume a sort of sound-induced blending of foreign and native words' in the case of the lexical set of OPrs. *hadiš-* 'dwelling place'. Among the several cases provided by the author (from Dashtestāni *had zadan* 'to reach the age of puberty' to Semnāni *hedār* 'boundary between two fields belonging to different landowners' to Sorani Kurdish *hed* 'power', 'authority'; 'weight' etc.), particularly noteworthy is the Western and Southern Balochi use of (*h*)*ədda* in relation to the set of spatial relationship which Filippone calls 'Control of the surrounding space'. After all, as the author writes while discussing the title of the famous tenth century Persian geographical text *Ḥudūd al-ālam*, «the cognitive association 'limit → (delimited) place' can be traced back to the contiguity relationship between these two concepts, and does not differ from that which produced Lat. *fīnēs* 'territory, land, country enclosed within boundaries' from (sing.) *fīnis* 'boundary, limit, border'».

A distinct historical approach qualifies the second couple of papers, where walls and bricks mark both very tangible and radically impalpable borders in space and time. Touraj Daryaee chooses to deal with the four frontier walls of the Sasanian empire, from the relatively well-known *Sadd-i Iskandar*, the Wall of Alexander in the North-East to the far less studied defensive system called *War ī Tāzīgān* (Wall of the Arabs) in Middle Persian Sources. The historical materiality of the wall-as-a-boundary and the obvious ideology, past and present, involved in any discourse about the building of architectural landmarks institutionalising an 'inside' and an 'outside', are the central themes of Daryaee's relatively short paper. As a matter of fact, as the author states at the very beginning of his essay, 'walls not only provided a physical protection against the others, but also suggested a mental projection of those within the civilized (inside/*ēr*) and the un-civilized (outside/*an-ēr*) realms, something that served to regulate the inevitable interaction between the two'. Without plunging into trivial presentist discussions, Daryaee's paper – significantly dedicated to the memory of a great philologist and elegant scholar of the 'idea of Iran' such as Gherardo Gnoli – is, nevertheless, not at all afraid of taking on, provocatively enough, the perception of the border walls *in the present*: Daryaee's treatment of the 'gated mentality' is an example of how a rigorous philological-historical approach may decide not to renounce to reclaim its role and commitment, beyond the fences of the academia.

On the other side – that of the nonmaterial 'borders' in time – Simone Cristoforetti's paper introduces, with a meticulous analysis which includes

mathematical reasoning as well as historical arguments revolving around the slippery notion of (Iranian) identity in the Ziyarid context (tenth-eleventh centuries), a new calendrical interpretation of a well-known landmark of North-East Iran such as the tower of Gunbad-i Kāvūs. This fascinating monument, built by Qābūs ibn Wushmgīr (the grandfather of Kay Kā'ūs ibn Iskandar, the author of the famous Persian *Fürstenspiegel* entitled *Qābūs-nāma*), becomes, in Cristoforetti's interpretation, an architectural representation of the cycles of solar time. All in all, the paper shows how the idea of a 'borderland' – ideological, political, identitarian – can be explored also by negotiating the manifold (and seldom systematically tackled *per se*) thresholds implied by the complex and symbolically meaningful systems adopted for the measurement of time, and their textualization in significant landscapes.

If the historical construction of limits in space and time, from the Sasanians to the Ghaznavids, is the core theme of the contributions by Daryae and Cristoforetti, the two papers of the section entitled «Iconography on a threshold» deal with the thin line between life and death in a historical-artistic perspective, from Tang China to Bahmani Deccan. Both Matteo Compareti and Sara Mondini, however, cross several other 'lines of control' (I intentionally recall the title of a brilliant contemporary art exhibition and project on 'partition as a productive space' co-curated, among others, by Iftikhar Dadi), those of culturalism and essentialist exclusivity, showing the depth and density of a net of visual interactions extended from Shaanxi to Pompei, from Gulbarga to Kerman. Matteo Compareti's study of the representation of winged creatures in the funerary architecture of the Sino-Sogdian context is, indeed, a good example of how the entire Eurasian space, from inner China to the Mediterranean, can be explored with no prejudicial 'cultural' interruption, while remaining at the same time well aware of the weight, in terms of representational semantics, of any projectually boundaried 'subdivision of the world'; in this particular case, the one represented in the paintings of the seventh-century Hall of the Ambassadors at Afrasyab – ancient Samarkand – «where the northern wall was associated with China, the eastern one with India (and, possibly, the Turks), while the two remaining walls were devoted to Sogdiana itself». As a matter of fact, it is Compareti himself who declares not to be afraid of being «possibly affected by that 'revisionist' trend that is simply critic of prejudicial theories concerning adoption and adaptation». The issue of borders between iconographic traditions is, consequently, taken up by following an anti-purist approach, aimed at debating many an invention of (national) tradition: namely, those relating to the famed fantastic creature called *sīmurgh* in New Persian, which Compareti analyses in a comparative fashion with the so-called 'Western' (another presentism: one should say Graeco-Roman, as the author correctly underlines) phoenix and the Chinese *Fenghuang*, reminding us how it should be considered 'normal



to expect iconographic exchanges' in a space and time dominated by an intense trans-regional trade.

The visual domain, one is tempted to add, is made of itineraries along and across the edges of innumerable mobile horizons: as Sara Mondini writes referring to the rhizomatic nature of the cultural and religious interactions in fifteenth-century Deccan – but her unpretentious observations are indeed of a far-reaching significance – in a 'morass of gaps that are still waiting to be bridged, historians can sometimes find support in artistic and architectural evidence'. Instead of trying to identify a teleologically clear-cut 'Sunni' or 'Shi'i' 'identity' (three terms, needless to say, which must be handled with care especially when dealing with a pre-modern context) for the Bahmani ruler Aḥmad Shāh I, Mondini is interested in finding bridges to cross the manifold borders involved in a polysemic spatiality such as that analysed in her paper. The architectural threshold represented by Aḥmad Shāh's tomb, Mondini's essay suggests, establishes a programmatic conversation on an aesthetic and stylistic level with the overlapping projections of Iran, Central Asia, the *mulkīs*, the *āfāqīs*, the Ne'matollahi order, etc.: in the art historian's own words «the impression one gets when crossing the threshold of the ruler's monument is not of a positive statement of adherence to a given religious persuasion, but rather of an ability to merge the visual languages typically employed in Shi'i and Sufi (Sunni?) contexts: it is as though the sovereign had wished to address each of his subjects in a language he could understand».

Without leaving the Subcontinent, the essays by Sunil Sharma and the present writer focus on the Indo-Persian (the hyphen itself is, here, a problematic border-bridge) literary and linguistic realm, from Mughal Kashmir to Nawabi Awadh. The threshold explored by Sharma is represented by a region, Kashmir, which has been often referred to in Persian as *Irān-i ṣaghīr* 'little Iran', for a perceived close relationship with the Iranian world and the long-standing rooting of Persian literary culture, including the steady inflow of scholars from the Iranian plateau. In his paper, Sharma looks at the symbolic frontier of Kashmir through the lens of the literary genre of Mughal pastoral poetry, which he identifies as 'topographical' or more precisely, using Paul Losensky's expression, 'urban-topographical', showing how much the conversation between the local and the cosmopolitan, in truly geographical terms, is a dominating feature of the literary developments that were taking place within the 'seven climates' – the reference here is to a famous 'universal' *taẓkira* studied by Sharma himself – of the Persophone world from the sixteenth century onwards. More specifically, the textual investigation offered by the author is an opportunity to reflect on the ways (and the limits) in which tropes, stylemes and literary codes can provide an array of meaningful paths to explore the edges of a semanticized space. As Sharma writes at the beginning of his study, focused on three different 'Iranian' and 'Indian' literary approaches

to Kashmir and not renouncing to a productive comparison with the coeval European pastoral fad: «The genre of Mughal pastoral poetry describing non-urban spaces commemorated the appropriation of places on the edges of the empire into the imperial domain [...]. From a cultural and historical point of view the appropriation of provincial rural spaces as part of the cosmopolitan capitals offers an alternate way of looking at the center-periphery and urban-rural binaries». From a certain perspective (I think here, for instance, of Jahangir's description of the valley as an 'ironclad bastion', and his insistence on 'walls' and 'gates'), Sharma's paper might be read in parallel, perhaps unexpectedly, with some of Touraj Daryaei's observations: the early modern literary reception of Kashmir to recreate a sort of Mughal Arcadia, in a context where the idea of Hindustan as the emperor's garden is common at least since Babur's time, shows how the idea of the garden-paradise can be reshaped and recast to formulate a propagandistic ideology built on aesthetic foundations.

Somehow responding to Sharma's analysis of the poetical walls encircling a fertile spatial idea such as Kashmir - a spatial ontology of the aesthetic being, if I may take the liberty to play on György Lukács' words - the contribution by the present writer is concerned with the construction of linguistic boundaries within the world of Persian at the end of the eighteenth-century. The author of the philological works analysed in the paper, Mīrzā Muḥammad Ḥasan Qatīl, is indeed a character positioned on, and traversed by, multiple thresholds: between the Mughal and the colonial world, between Iran and Hindustan, between his Khatri heritage and his conversion to Shia Islam. The 'borders' explored through the figure of Qatīl (not by chance, he is also the author of an interesting doxographic work on the traditions of the 'Hindus' and the 'Muslims') are, thus, the manifold fences encircling the space of speech and the superimposition of hegemonies, hierarchies and identifications, both private and public, with their holes and ruptures, on threshold of a quickly happening nationalization of the linguistic traditions all around Eurasia.

As Augusto Cacopardo underlines in the title of his essay, the two papers making up the fifth section are devoted to the untold borderland of 'a world in-between', the little-studied area of the Hindu Kush/Karakoram region formerly known as Kafiristan, sometimes curiously - and very tellingly - misunderstood as a fantastic place *invented* by Rudyard Kipling, who located there his well-known short novel *The Man Who Would Be King* (1888). As Edward Marx brilliantly noticed a few years ago in an acute and well-informed article this is the case, for instance, of the *New York Times* columnist Michael Specter who defined Kafiristan as a 'mythical' kingdom in a condescending 1995 piece on post-Soviet Central Asia, or of literary critics such as Mark Paffard, who thought it was Kipling himself to situ-

ate this place where it actually belongs.<sup>6</sup> Beyond the blunders of careless journalists or historically uninformed theorists, it is worth underlining how this invisible frontier – partially extending over the area studied by Georg Morgenstierne in his 1920s survey *Indo-Iranian Frontier Languages* – has been playing a technically pre-textual function in many of the narratives relating to it, during, after and before the colonial world. Well before Kipling, in a literary milieu still relating to the Mughal protocols, one might consider the stories put forward by the local *Shahnama-yi Chitral*, who sees its inhabitants as Zoroastrians, and the Persian ethnography commissioned to a certain Hajji Ilaḥdad from Peshawar by the French general Claude Auguste Court, where the *Kāfirān* are described as Manichaeans.<sup>7</sup> In this context, the papers by Augusto Cacopardo and Max Klimburg give a three-dimensional depth to the contours of such complexity, showing the multiple layers of interaction of this frontier region with the surrounding cultural spaces and, more in general, the wider Eurasian arena, in a *longue-durée* chronological perspective. In particular, Cacopardo's essay is among the first studies on the pre-Islamic and non-Islamic (the Kalasha milieu) cultural spaces of the area to show, in a systematic way, several possible paths for what the author calls a «comparative research» with «the Iranian world», hitherto neglected in favour of the interconnections and comparisons with the Indian sphere.

From the borderland between the Iranian plateau, Central Asia and the Indian world, the sixth section moves to the boundaries of the discourse on identity and otherness in Iran itself, with some recapitulatory notes by the historian Biancamaria Scarcia Amoretti and a brief case study by the anthropologist Christian Bromberger. According to Scarcia Amoretti, «Iran could be the best test case to try to define in a plausible and shared way a sort of persuasive inventory of the conceptual categories in which to place the question of the 'boundary' itself». To develop such a challenging statement, she articulates her *marginalia* in conversation with previous writings on the issue of 'Iranian identity', from the multiple authors entry in the *Encyclopaedia Iranica* to the collective volume *Iranian Identity in the Course of History* edited by Carlo Cereti and published in 2010. In her nuanced treatment of an issue at evident risk of essentialist teleologism, the author insists on how the processes of boundarization and identification at play in Iran since the Arab conquest and the Islamization of the former Sasanian domains can't be understood following a unitarian grand narration, nor by light-heartedly adopting heavily culturalized categories

6 See Edward Marx, «How we lost Kafiristan», *Representations*, Summer 1999, pp. 44-66.

7 I have dealt with these and other ethnographic imaginations on Kafiristan in Pellò S., «Massoni o manichei? Immaginario etnografico sui Kafiri dell'Hindukush», *Hiram*, 2, 2009, pp. 95-104.

such as those of mother tongue or homeland. Indeed, more than dealing with boundaries and the notion of identity as such, one has the impression that Scarcia Amoretti is actually suggesting a discussion of the polysemic territories of identity along the rugged borders, internal and external, of the Iranian space. The five paragraphs of her essay, devoted, namely, to key conceptual terms such as 'identifications', 'Islam', 'language', 'élite' and 'homeland', though obviously interconnected, can be read as separate itineraries on the edges of different strategies of semantization, in dialogue with several theoretical approaches, starting from Alessandro Bausani's articulate and still influential – at least in the Italian context – discourse on the religious history of Iran and the Islamic world.

Complementary to Scarcia Amoretti's broad reach discussion, the savoury anthropological paper by Christian Bromberger briefly delineates some social and linguistic modalities to define, institute and negotiate 'otherness' in the northern Iranian regions of Gilan and Talesh. In the first of the two cases presented in the paper, the author shows a typical example of how a discursive process of boundarization and differentiation between 'close Others' can structure itself over food and sexuality; in the second, which is particularly relevant to the present day situation well beyond the borders of the western Caspian region, he provides a vivid glimpse of the local ways to accommodate the 'Shia' and 'Sunni' milieux. Particularly noteworthy, as far as the case of lowland Gilan as opposed to the highlands of the Iranian plateau is concerned, is the ultimate connection that Bromberger establishes with some traditional subdivisions/oppositions of human geography, showing the persistence of conceptions going back to Abbasid geographical writing and, ultimately, to ancient Greece. More in general, Bromberger's pages can be read as a useful warning against the risks involved in any generalization: a celebration of the invaluable wealth of differences within a non-monolithic Iran and, at the same time, – I here especially have in mind his only apparently naive 'Taleshi solution' – a committed *pamphlet* against the global multiplication of abusive walls and cages.

As Franco La Cecla writes in a conceptually dense passage quoted by Marco Dalla Gassa, «Misunderstanding is boundary that takes form. It becomes a neutral zone, a *terrain-vague*, wherein identity, respective identities, can establish themselves, remaining separate by precisely a misunderstanding». The last two chapters of this book, which have been collected in a visual section called *Mirrors and beyond*, deal explicitly with the illusion of the borders and the misunderstandings conjured by the construction of fenced, crystallized prototypes. The following statement by Dalla Gassa is, in this sense, exemplary, and acquires, in the context of our discussion, a dimension which by far exceeds the narrow scope of an academic essay on cinema studies: 'Each original is original to the extent that it has its own temporality, more or less limited, more or less inclined

to being corrupted'. In particular, Dalla Gassa is concerned with the use that one of the greatest directors in film history, the recently deceased and much missed Abbas Kiarostami, makes of the instrument-metaphor of the mirror in a 2010 movie shot in Tuscany, *Certified Copy*, with Juliette Binoche and William Schimell. In a sophisticated analysis responding, among others, to the phenomenology of Maurice Merleau-Ponty, he shows how the mirror of Kiarostami becomes 'a liminal space, a border-land', overlapping with the circumscribed frame of the camera. And it is precisely around a liminal space of refractions that Riccardo Zipoli's words and images revolve, as a visual closure for this book. Through the prismatic surfaces of the verses of Mīrzā Bīdil (1644-1720) - the 'poet of the mirrors' as Muḥammad Shafī'ī-Kadkanī brilliantly defined him - and through the photographer's eye, Iran dissolves, in the end, in a multitude of reflections scattered all around the world, becoming a meaningful pretext to explore and expose the limits of the frames of identification and recognition.

Riomaggiore and Venice, Tīr 1395



## **0 Crossings**





## **Borders**

Itineraries on the Edges of Iran

edited by Stefano Pellò

## **Sui confini della poesia**

Gianroberto Scarcia

(Università di Ca' Foscari Venezia, Italia, *emeritus*)

Accettando con gratitudine l'affettuoso invito a inaugurare questa ennesima iniziativa della scuola veneziana, chi scrive plaude, senza riserve, anzitutto all'esplicita, significativa novità metodologica costituita da una chiara e consapevole impostazione di quelle che sono nostre consolidate esperienze di ricerca 'eurasiatica' in un quadro di culturale 'ecumenismo' (intenderei con questo evitare l'inflazionato termine 'globalità', ormai inesorabilmente segnato dall'ovvietà di una banale piattezza e provinciale sudditanza a un pensiero dominante imperiale che impone anche censure a priori) volto a farla finita, si spera una volta per tutte, con il logoro schema dell'incontro/scontro fra Oriente e Occidente. Era quello uno schema che dava per scontata l'obiettività naturale (coloniale) delle due pretese modalità umane dell'essere e del pensare, che peraltro trovavano poi il loro 'fra', il loro 'ponte', pressoché dappertutto, a ogni latitudine, facendo di ogni singola reperita eccezione un tassello di opposta verità. E credo, in proposito, che la 'metafisicità' dell'Oriente (Oriente tout-court) sia un po' come il biancore della classicità: frutti, ambedue, di pregiudizi inveterati, duri da superare nonostante l'evidenza delle concrete occasioni che da tempo avrebbero dovuto avviare il discorso stesso verso categorie nuove, ben altrimenti plausibili. Ma con ciò afferro anche l'occasione di dare, io stesso, maggiore visibilità alla veste che oso considerare appartenente al medesimo ordine di idee, da me tessuta in privato, quale dono natalizio per Gilbert Lazard, sulle fattezze di Edward Fitzgerald. Una veste che si spingesse, nelle sue pieghe, ancora al di là degli intendimenti vetero-esotistici del celebre scopritore/'traduttore' di glorie iraniche al tempo ignote anche in casa. Una veste, peraltro, che, non illudendosi di superare quegli intendimenti, fosse ancora più persiana nella concettosità ma fosse anche, al contempo, decisamente (formalmente) 'occidentale' nella sonorità, aspirante a quella dell'endecasillabo italiano. Il tutto nella piena coscienza, comunque, di non fare in tal modo, di necessità, mero orientalismo (cioè, in sostanza, di non essere meno occidentale) dell'interprete canonico britannico.

Un secondo esperimento, che sottopongo anch'esso a indulgente attenzione, si muove sulla solita lunghezza d'onda del mio costante sforzo

---

### **Eurasiatica 5**

DOI 10.14277/6969-100-3/EUR-5-1

ISBN [ebook] 978-88-6969-100-3 | ISBN [print] 978-88-6969-101-0 | © 2016

teso a far emergere quelle che considero affinità di fondo fra tradizioni culturali che insisto a chiamare primariamente ellenistiche indipendentemente dalle diverse strade nel prosieguo imboccate. Propongo infatti (ed è cosa che non potrei ovviamente fare se non nella mia lingua natale) la forma 'esametrica' a me consueta in terreno poetico persiano per versioni barbare (sì, proprio 'ajam) di esempi di lirica greca (non solo ellenistica, essa, ma in particolare tardo-antica, certo) a mio parere tutt'altro che estranee all'humus sul quale matura, nutrita da pochi sentimenti e sensazioni semplici, fondamentali, più umani che trasversali, eterni, anche banali e anche retorici, l'ispirazione della poesia persiana (stavolta quella più antica, certo). Matura alla Frazer, se si vuole, fuori moda e mode, e in assenza di qualunque pretesa, da parte mia, di ricognizione di storici nesi, che solo possono essersi dati, e che non solo non intendo ma neppure ritengo necessario né opportuno indagare. Ciò detto, sono ben conscio - notizia di cosa che vorrei sperare evidente - dell'ovvia monotonia (in senso etimologico) che è inevitabile nell'opera di un traduttore il quale è sempre lo stesso, ovvero, in parole povere, non è né cinese né greco né persiano. Aggiungo solo, quanto a monotonia, che mi sento di dover chiedere venia, in questo caso, se il paesaggio 'ajam che evoco di mio in terra ellenica si fa una volta tanto meno astratto che nella mia maniera solita di 'iperpersianizzare', cioè 'platonizzare' (equivalenza e giudizio di Alessandro Bausani) la poesia persiana per quanto riguarda nomi, toponimi, personaggi, in breve elementi storici. E stavolta l'offerta era stata, appunto, alla memoria di Alessandro Bausani, altro Maestro, pensando io, in particolare, al suo tentativo, a mio parere felice pur se non storicamente documentato neppure quello, di reperire armonia 'turanico-serica' nella quartina persiana.

Con il che passo al terzo esperimento, per il quale devo molto ad Alfredo Cadonna, che tendenziosamente echeggio; non sarebbe del resto possibile pensare che il cinese facesse anch'esso parte, come Bausani stesso avrebbe auspicato, del bagaglio presunto in un antico liceale classico romano (accanto all'arabo: arabo inteso, credo, alla proto-orientalistica, cioè come veicolo di una cultura almeno triplice). Chiamo dunque in causa Bai Yuchan (secoli VII-VIII), cioè cosa che definirei 'impressionista', per un confronto armonico con Baba Taher (secolo X), cioè con cosa che definirei 'espressionista'. E il richiamo consisterebbe in questo, che dove Bausani vede cose dette in maniera poetica comunque simile nella forma - con la conseguente ipotesi del contagio - io vedo le stesse cose, ma non più trasversali, nella diversità della loro definizione appercettiva nella cassa armonica di una modulazione che dà voce (registro, timbro...) analoga a quelle reazioni immediate dell'anima. Sentimenti e sensazioni affini? Io penso che si tratti comunque, in ambo i casi, dell'incunabolo di un'accademia là meno qua più a venire, forse di una vera e propria gabbia stilistica in fieri, nel modo di tradurre in ritmo proprie attitudini o viscere, sulla

strada di quella che sarà ben presto la via maestra, puntellata da episodi di continua automimesi.

In quarto luogo - sorta di progressione che vorrei coerente nel mio confesso orientalismo - mi industrio a dare - dono anche questo agli allievi - sonorità persiana (che io ritengo persiana, ovviamente), con tanto di *radif* (cioè con quella che è la *trouvaille* per eccellenza della poesia persiana, e che io considererei il 'titolo' delle composizioni piuttosto che il ritornello), a topoi e giochi di parole quotidiani ed usuali: nel caso, peraltro, nostrani, cioè per noi ovvi, facili, immediatamente riconoscibili, come tratti da una sorta di vademecum, repertorio, rimario... Penso, in altre parole, a proporre poesia (diciamo *nazm*) alla persiana, cioè utilizzando, ma con materiale occidentale (sempre ellenistico, ovviamente), lo stesso sistema di trasferimento dalle sensazioni all'immagine che mi risulta sia stato operato da quelle parti; dove vorrei che tutto fosse molto esplicito. Chiarisco solo che dovrebbe trattarsi di un epitalamio, compresi i tratti giocosi, se non satirici, contemplati nel genere, che nel caso attengono però a certo realismo anche un po' brutale dell'"altra" tradizione: allusioni a quelle che vengono presentate come le fasi lunari passeggiare, transeunti, superabili ma in certo senso inevitabili se non necessarie, di un erotismo proteso verso il plenilunio della conclusione idilliaca in un senso che possiamo anche considerare bempensante. In parole più esplicite, allusioni di adolescenzialità di novilunio a quel 'rastrello' da intendersi alla Freud, e ancor meglio alla Groddeck. Al che aggiungo, da ultimo, anche il motivo della composizione offerta come 'risposta' ad opera di altri poeti, consonante e dissonante.

La dedica, stavolta, è taciuta.

I.

نمونه ها ای از رباعیات ادوارد فیتزجرالد که بمناسبت یوم فرخفال ولادت استاذ ژیلبر لازار بدست حقیر شکارچی از نظم انگلیسی شرفزده بنظم فارسی غربزده باز آورده شده است

1

Come, fill the Cup, and in the Fire of Spring  
The Winter Garment of Repetance fling:  
The Bird of Time has but a little way  
To fly - and Lo! the Bird is on the Wing.

بیا بشعلهٔ تـا ک بهارخیز  
باد خزان توبه را کن خاموش  
بالزن پر روزگار یک دم است  
خاکستر این سیمرغ گوری عنین است

2

Oh, Thou, who Man of baser Earth didst make,  
And who with Eden didst devise the Snake;  
For all the Sin wherewith the Face of Man  
Is blacken'd, Man's Forgiveness give - and take!

تو کز حنای گل آراستی مرا  
که تار مهد من بافتی بـماری  
سیمای گناهگون را کن روشنم  
بر خلق فیرفته بکش آستین

3

And look - a thousand Blossoms with the Day  
Woke - and a thousand scatter'd into Clay:  
And this first Summer Month that brings the Rose  
Shall take Jamshýd and Kaikobád away.

شکوفه های بام شکونه کرد غروب  
جامهٔ گل گلفام و تیره گشت  
تیرگان که سرخاب داده چمن را  
بسرمهٔ گیتی انباشته است جام را

4

One Moment in Annihilation's Waste,  
 One Moment, of the Well of Life to taste -  
 The Stars are setting and the Caravan  
 Starts for the Dawn of Nothing - Oh, make haste!

در بیابان نیستی يك دم ابد است  
 شب حیات قطرهٔ تار ازل است  
 ستاره ها بخواب کاروان تازان است  
 عجله کن که دست اجل عجیل است

5

Írám indeed is gone with all its Rose,  
 And Jamshýd's Sev'n-ring'd Cup where no one knows;  
 But still the Vine her ancient Ruby yields,  
 And still a Garden by the Water blows.

ارام پژمرده رفته بباد  
 خطوط جام جم شد ناپدید  
 ولیك می گلگون فروز افزون است  
 برمضان باغ تر انگبین است

6

AWAKE! for Morning in the Bowl of Night  
 Has flung the Stone that puts the Stars to Flight:  
 And Lo! the Hunter of the East has caught  
 The Sultán's Turret in a Noose of Light.

برخیز در ناو شب انداخت بامداد  
 سنگی که رماند فر اختران را  
 وز تار پيله باف خاور همای  
 همایون فر حریر را گرفت دامی

7

Now the New Year reviving old Desires,  
 The thoughtful Soul to Solitude retires,  
 Where the White Hand of Moses on the Bough  
 Puts out, and Jesus from the Ground suspires.

نوروز احیاپرور رویاها ای  
خلوتخانه فروهر ای  
بقدمهای خضر تو بیضا یدای  
عیسی دم نسیمها ای

8

The Worldly Hope men set their Hearts upon  
Turns Ashes – or it prospers; and anon,  
Like Snow upon the Desert's dusty Face  
Lighting a little Hour or two – is gone.

بر بادیه غل برف است امید  
کز ابر وهم باریده است دلها را  
بیهوده زهری بیهوده تریاقی  
آن سیم بزر تبدیل شود بدمی

9

And David's Lips are lock't; but in divine  
High piping Péhlevi, with 'Wine! Wine! Wine!  
Red Wine!' – the Nightingale cries to the Rose  
That yellow Cheek of her's to' incarnadine.

ختم لب داوود نی است که زاری  
دیرینه گرید بلبلمانند بگلی  
فریاد رس گونه زرد مگرت  
یاری بخشد رنگ خمیری ناگاهی

10

And, as the Cock crew, those who stood before  
The Tavern shouted – 'Open the Door!  
You know how little while we have to stay,  
And, once departed, may return no more.'

ز لمغ بانگ خروس آستان رویان را  
بدیده سوزانده خواب گران را  
باز نمائی که نیائی واپس  
نعره زد میکده کذر این در را

## II.

V 135

ΑΔΗΛΟΝ

Στρογγύλη, εὐτόρνευτε, μονούατε, μακροτράχηλε,  
 ὑψάυχην στεινῶ φθεγγομένη στόματι,  
 Βάκχου καὶ Μουσέων ἰλαρὴ λάτρι καὶ Κυθερείης,  
 ἠδύγγελως, τερπνὴ συμβολικῶν ταμίη,  
 τίφθ', ὀπόταν νήφω, μεθύεις σύ μοι, ἦν δὲ μεθυσθῶ,  
 ἐκνήφεις; ἀδικεῖς συμποτικὴν φιλίην.

O tu anfora, tonda, tornita, dall'agile collo, l'orecchio  
 Ben adorno favella da labbra socchiuse,  
 O tu che del rito d'amore sei ancella giocosa,  
 Che dolcemente sorridi, ministra di lieti simposi,  
 Perché, quando non bevo, sei ebbra,  
 E poi quand'io lo sono sei sobria?

V 233

ΜΑΚΗΔΟΝΙΟΥ ΥΠΙΑΤΙΚΟΥ

«Αὐριον ἀθρήσω σε.» Τὸ δ' οὐ ποτε γίνεται ἡμῖν,  
 ἠθάδος ἀμβολίης αἰὲν ἀεξομένης.  
 ταῦτά μοι ἱμεῖροντι χαρίζεται· ἄλλα δ' ἐς ἄλλους  
 δῶρα φέρεις, ἐμέθεν πίστιν ἀπειπαμένη.  
 «᾽Οψομαι ἐσπερὶ σε.» τί δ' ἔσπερός ἐστι γυναικῶν;  
 γῆρας ἀμετρήτω πληθόμενον ρυτίδι.

Ti vedrò, dici, domani, ma questo domani non sorge  
 Per me mai, dilazione che è sempre più lunga.  
 Sol questo accordi tu al mio desiderio, ben altri favori  
 Porgi agli altri, e, la fede ch'io t'offro, respingi.  
 Ti vedrò, dici, a sera. E qual è poi la sera dei belli?  
 È rugosa vecchiaia, la sera, entro trame di buio irretita.

V 251

ΕΙΡΗΝΑΙΟΥ ΡΕΦΕΡΕΝΔΑΡΙΟΥ

᾽Ομματα δινεύεις κρυφίων ἰνδάλματα πυρσῶν,  
 χεῖλεα δ' ἀκροβαφῆ λοξὰ παρεκτανύεις,  
 καὶ πολὺν κιχλίζουσα σοβεῖς εὐβόστρυχον αἴγλην,  
 ἐκχυμένας δ' ὀρώω τὰς σοβαρὰς παλάμας.  
 ἀλλ' οὐ σῆς κραδίης ὑψάυχενος ὤκλασεν ὄγκος·  
 οὐπω ἐθελύνθη, οὐδὲ μαραινομένη.

Rotei l'occhio, svelando la fiamma nascosta,  
Fan moine le labbra dipinte, e tu ridi,  
Ridi sì che al tuo ricciolo i cappi scomponi  
E languida vedo la mano che s'apre a ghermire.  
Non s'è fiaccata la boria, però, del tuo cuore spietato,  
Non più mansueto s'è fatto con gota che punge.

V 270

ΠΑΥΛΟΥ ΣΙΛΕΝΤΙΑΡΙΟΥ

Οὔτε ῥόδον στεφάνων ἐπιδεδύεται οὔτε σὺ πέπλων  
οὔτε λιθοβλήτων, πότνια, κεκρυφάλων.  
μάργαρα σῆς χροίης ἀπολείπεται, οὐδὲ κομίζει  
χρυσὸς ἀπεκτῆτου σῆς τριχὸς ἀγλαΐην·  
Ἴνδῶν δ' ὑάκινθος ἔχει χάριν αἴθοπος αἴγλης,  
ἀλλὰ τεῶν λογάδων πολλὸν ἀφαιροτέρην.  
χεῖλεα δὲ δροσόεντα καὶ ἡ μελίφυρτος ἐκεῖνη  
στήθεος ἀρμονίη κεστὸς ἔφν Παφίης.  
τούτοις πᾶσιν ἐγὼ καταδάμναμαι· ὄμμασι μούνοις  
θέλωμαι, οἷς ἐλπὶς μείλιχος ἐνδιαίει.

Alla rosa non serve corona, non giova mantello,  
E non velo, tempesta di gemme, conviene.  
Opaco fanno, codeste tue gotte, il rubino,  
E pallido l'ebano rende l'effusa tua chioma.  
Ben ha il giacinto dell'India, la grazia d'un fulgido sguardo,  
Ma, fronte a quelle pupille, è un bagliore sopito.  
Di rugiada le turgide labbra ed il seno di miele:  
È pienezza che scuote e travolge l'industria dell'ape.  
Son disperato, son vinto, conforto potrebbe a me dare  
Un balenio solamente, in quegli occhi socchiusi, di misericordia.

VI 18

ΙΟΥΛΙΑΝΟΥ ΑΠΟ ΥΠΑΡΧΩΝ ΑΙΓΥΠΤΙΟΥ

Λαῖς ἀμαλδυνθεῖσα χρόνῳ περικαλλέα μορφὴν  
γηραλέων στυγέει μαρτυρίην ῥυτίδων·  
ἔνθεν πικρὸν ἔλεγχον ἀπεχθήρασα κατόπτρου  
ἄνθετο δεσποίνῃ τῆς πάρος ἀγλαΐης.  
« Ἄλλὰ σύ μοι, Κυθήρεια, δέχου νεότητος ἑταῖρον  
δίσκον, ἐπεὶ μορφὴ σὴ χρόνον οὐ τρομέει. »

Una ad una corrode Saturno le forme leggiadre,  
E testimone ora aborron le annose sue rughe.



Perciò sullo specchio che antico splendore rinfaccia  
 Alitò questa ruggine verde che il tempo nasconde.  
 Ma tu raschia il tempo, e il compagno alla mia giovinezza  
 T'apparirà, corpo esile, turgido, eterno.

VI 83

ΜΑΚΗΔΟΝΙΟΥ ΥΠΙΑΤΟΥ

Τὴν κιθάρην Εὐμολπος ἐπὶ τριπόδων ποτὲ Φοίβῳ  
 ἄνθετο, γηραλέην χεῖρ' ἐπιμεμόμενος,  
 εἶπε δέ· «Μὴ ψαύσαιμι λύρης ἔτι μηδ' ἐθελήσω  
 τῆς πάρος ἀρμονίης ἐμμελέτημα φέρειν.  
 ἠιθέοις μελέτω κιθάρης μίτος· ἀντὶ δὲ πλήκτρον  
 σκηπανίῳ τρομερὰς χεῖρας ἐρεισάμεθα.»

Questo liuto sul tripode, incenso che arda,  
 Dal menestrello canuto rampogna all'inerte suo dito!  
 Più non voglio, non posso accostarlo, né darmi  
 All'arte armoniosa che esercitavo, sì cara.  
 Ai giovani, dunque, la cetra, ché, in luogo del plettro,  
 Posar sul bastone oggi debbo le tremule mani.

VI 294

ΦΑΝΙΟΥ

Σκίπωνα προποδαγὸν ἱμάντα τε καὶ πυρικοίταν  
 νάρθηκα, κροτάφων πλάκτορα νηπιάχων,  
 κίρκον τ' εὐολκὸν φιλοκαμπέα καὶ μονόπελμον  
 συγχίδα καὶ στεγάναν κρατὸς ἐρημοκόμου  
 Κάλλων Ἑρμεία θέτ' ἀνάκτορι, σύμβολ' ἀγωγᾶς  
 παιδείου, πολὺ γυῖα δεθεῖς καμάτῳ.

Una bisaccia, una ruvida pelle di capra, non concia,  
 E un bastone, ai suoi passi puntello, ed un arida fiasca.  
 Queste sono le spoglie che allo sparuto derviscio conviene  
 Affidare alla mano che il tamarisco salmastro gli tende.

IX 361

ΛΕΟΝΤΟΣ ΦΙΛΟΣΟΦΟΥ

Μῆτερ ἐμὴ δύσημτερ, ἀπηνέα θυμὸν ἔχουσα,  
 λίην ἄχθομαι ἔλκος, ὃ με βροτὸς οὔτασεν ἀνὴρ  
 νύκτα δι' ὄρφναίην, ὅτε θ' εὐδουσι βροτοὶ ἄλλοι,  
 γυμνὸς ἄτερ κόρυθος τε καὶ ἀσπίδος, οὐδ' ἔχεν ἔγχος·

πάν δ' ὑπεθερμάνθη ξίφος αἵματι· αὐτὰρ ἔπειτα  
οὐρόν τε προέηκεν ἀπήμονά τε λιαρόν τε.

O madre mia poco madre, che mi facesti leggiadro,  
Troppo cruda è la piaga che al fragile corpo fu aperta  
Nel buio notturno, nel sonno di tutti i mortali,  
Quando, ignudo, non scudo portavo, non elmo, non lancia.

IX 449

ΑΛΛΟ

Τίς πυρὶ πῦρ ἔδαμασσε; τίς ἔσβεσε λαμπάδι πυρσόν;  
τίς κατ' ἐμῆς νευρῆς ἑτέρην ἔτανύσσατο νευρῆν;  
καινὸς Ἔρωσ κατ' Ἔρωτος ἐμῶ μένει ἰσοφαρίζει.

Ecbatana o Tisfuna, il vigneto o la spuma dell'orzo?  
Chi spegne il fuoco con fiamma e lucerna con lume?  
Chi a me lungo la corda dell'arco sa tendere corda?  
Ebbene, oggi affronta, il mio Amore, con furia, un amore novello.

IX 768

ΑΓΑΘΙΟΥ ΣΧΟΛΑΣΤΙΚΟΥ

Παίγνια μὲν τάδε πάντα· Τύχης δ' ἑτερότροπος ὄρμη  
ταῖς ἀλόγοις ταύταις ἐμφέρεται βολίσιν·  
καὶ βροτέου βιότου σφαλερὸν μίμημα νοήσεις,  
νῦν μὲν ὑπερβάλλων, νῦν δ' ἀπολειπόμενος.  
αἰνέομεν δὴ κεῖνον, ὃς ἐν βιότῳ τε κύβῳ τε  
χάρματι καὶ λύπῃ μέτρον ἐφηρμόσατο.

Gioco, è questo, non altro: nei colpi di dardo che privo  
È di ragione, fa mostra di sé la Fortuna,  
E della vita l'immagine nostra, malcerta,  
Che ora è trionfo, or precipite cala.  
E nell'esistere e al gioco dei dadi dobbiamo lodare  
Chi sa tener la misura, e di gioia e di cruccio.

X 64

ΑΓΑΘΙΟΥ ΣΧΟΛΑΣΤΙΚΟΥ

Ἦ ρά γε ποῦ τὸ φρύαγμα τὸ τηλίκον; οἱ δὲ περισσοὶ  
πῆ ἔβαν ἐξαίφνης ἀγχίποροι κόλακες;  
νῦν γὰρ ἐκὰς πτόλιος φυγὰς ὤχεο· τοῖς πρότερον δὲ  
οἰκτροῖς τὴν κατὰ σοῦ ψῆφον ἔδωκε Τύχη.

πολλή σοί, κλυτοεργὲ Τύχη, χάρις, οὔνεχ' ὁμοίως  
πάντας ἀεὶ παίζεις κείσεται τερπόμεθα.

Ove andò l'alterigia di un tempo? Ove andarono a un tratto  
Gli innumerevoli amanti che avevi vicino?  
Oggi, esule devi fuggire la patria e Fortuna  
Ai tapini d'un tempo la sorte tua offre.  
A te rendo grazie, o Fortuna, di tanto prodigio operosa.

XI 49

ΕΥΗΝΟΥ

Βάκχου μέτρον ἄριστον, ὃ μὴ πολὺ μηδ' ἐλάχιστον·  
ἔστι γὰρ ἢ λύπης αἴτιος ἢ μανίης.  
χαίρει κιννάμενος δὲ τρισὶν Νύμφαισι τέταρτος·  
τῆμος καὶ θαλάμοις ἐστὶν ἐτοιμότητος·  
εἰ δὲ πολὺς πνεύσειεν, ἀπέστραπται μὲν Ἐρωτας,  
βαπτίζει δ' ὕπνω, γείτοني τοῦ θανάτου.

Misura perfetta del vino è non troppo, non poco,  
Ché, poco, l'anima tedia, e, se troppo, sconvolge.  
Ma tu, alle tre coppe, tu aggiungi la quarta, e, sta' certo,  
Al successo nel talamo lena alimenta e conforta.  
Però, se la quinta ribolle, discaccia lontano l'amore,  
E il vino ti immerge nel sonno, finitimo a morte.

XI 349

ΠΑΛΛΑΔΑ

Εἰπέ, πόθεν σὺ μετρεῖς κόσμον καὶ πείρατα γαίης  
ἔξ ὀλίγης γαίης σῶμα φέρων ὀλίγον.  
σαυτὸν ἀριθμησον πρότερον καὶ γνῶθι σεαυτόν,  
καὶ τότε ἀριθμήσεις γαῖαν ἀπειρεσίην.  
εἰ δ' ὀλίγον πηλὸν τοῦ σώματος οὐ καταριθμεῖς,  
πῶς δύνασαι γνῶναι τῶν ἀμέτρων τὰ μέτρα;

Il mondo vuoi soppesare, i quattro elementi del cosmo,  
Se tu un corpo fatto di nuda terra possiedi?  
Le tue misure dapprima, a conoscerti bene,  
Ché solo dopo avrai braccia per spazi infiniti.  
Se il pugno di fango che sei tu non puoi calcolare,  
Come saprai misurar ciò che sfugge a misura?

XII 226

ΣΤΡΑΤΩΝΟΣ

Πάννυχτα μυδαλόεντα πεφυρμένος ὄμματα κλαυθμῶ  
ἄγρυπνον ἀμπαύω θυμὸν ἀδημονίη,  
ἦ με κατ' οὖν ἐδάμασσε ἀποζευχθέντος ἐταίρου,  
μοῦνον ἐπεὶ με λιπὼν εἰς ἰδίην Ἔφεσον  
χθιζὸς ἔβη Θεόδωρος· ὃς εἰ πάλι μὴ ταχὺς ἔλθοι,  
οὐκέτι, μουνολεχεῖς κοῖται, ἀνεξόμεθα.

Molli per tutta la notte le insonni pupille,  
Io pasco l'egro mio male vegliando il dolore  
Che m'ha prostrato così, perché lungi è fuggito l'amico:  
A Shirvan, alla patria, lasciandomi solo e negletto.  
Se ne partiva di qui ieri sera e, se oggi non torna,  
Domani per me a Samarcanda non sorge più il sole.

### III.

Bai Yuchan

La vastità della terra, dei monti e dei fiumi? Un mio scritto.  
Guardi al titolo, e t'è già ben chiaro lo scritto.  
Da fiori e da erbe si leva, concorde, una recita, una.  
Per chi sa ascoltare, sol tenda l'orecchio, palese è lo scritto.

Corruccio di monti, e la nebbia color di martin pescatore,  
La luna è l'occhio d'un ebbro truccato, nel cielo.  
Frantuma il riflesso del loto, la giovane gru, sopra l'acqua,  
Ma sale, placato dal vino, l'azzurro mio verso nel cielo.

Baba Taher

Son l'uccello che basta dispieghi le ali di fiamma  
Perché il mondo tutto s'infocchi in incendio di fiamma.  
E, se un pittore dipinge l'immagine mia sopra un muro,  
Tutta avvolge, il mio simbolo rosso, la casa di fiamma.

Per me non fu gioia prevista, sconvolto  
Io fui plasmato, di fango il modello sconvolto.  
Di tutta la gente creata che torna alla terra  
Argilla hanno fatto, Taher fabbricando sconvolto.

## IV.

Oh, plenilunio remoto, la notte che vegli in attesa:  
 Menzognera, la falce di vasto raccolto in attesa!  
 Talloni di piombo non lasciano orma veruna  
 Sulla roccia di questo deserto fremente d'attesa.  
 Non è muro ove battere il capo voglioso e impaziente  
 Nel levigato pianoro ove, tremulo, è solo un miraggio d'attesa.  
 Uno strale, lo sguardo, di voce che fugge dal seno dell'occhio,  
 E, non meno veloce che nota, si spegne, quel raggio d'attesa.  
 Intorbida a valle, la sete del tenero agnello,  
 La fonte che abbevera furia di lupo in attesa.  
 Si plauda all'altero leone, sdegnoso a pretesti,  
 Cui rossore non tinge criniera tiranna in attesa.  
 Quel sacro cuore s'intrida di tepido sangue creato,  
 Ché fu detto: «Io vi guido», e poi imperscrutabili vie per l'attesa!  
 Si fece in quattro, una provvida mente, a dar veste  
 A un cosmo di forme anelanti, di senso in attesa.  
 Acqua il pianto, e di fuoco il dolore, e violenza di vento,  
 Poi l'ipocrita terra a coprire ogni segno d'attesa.  
 Si morse le mani, la lena affannata di quel piede insonne:  
 Ohimè, troppo lungo, ogni passo, alla debole gamba in attesa!  
 Orla il velo, dentato rastrello, a verginità di giardino:  
 Dai viburni saprà prender volo crepuscolare farfalla d'attesa?  
 Ma primavera coppia non abbia il poeta in ritroso disdegno:  
 Chi non seppe del sale di Lot non saprà qual dolcezza è in attesa.

Così risponde Janruba all'inane evocazione, da parte di Giovanni, delle farfalle crepuscolari, e all'apostrofe di Gabriele alla luna calante, falce protesa inane a raccolto.



# **1 A Marchland of Words**





## Borders

Itineraries on the Edges of Iran

edited by Stefano Pellò

# Additional Considerations about Ved. *Síndhu-*, Av. *Hiṇdu-/Həṇdu-*

Antonio Panaino

(Università di Bologna, Italia)

**Abstract** In a very important article Paul Thieme demonstrated that Ved. *Síndhu-* was a nominal *-u-* formation, based on a non-attested present stem *\*sinadh-/sindh-* derived by a root *sidh* (usual present stem *sadha-*). Then, *\*sindhú-* would mean ‘warding off, keeping away’, while the corresponding substantivization as *síndhu-*, m./f., (with the stress on the root) meant ‘he/she who wards off, keeps away’, i.e. ‘natural frontier’. Notwithstanding the evident absence of a present stem like *\*sinadh-/sindh-*, the reconstruction suggested by Thieme is still the most reasonable in the light of the R̥gvedic passages where the older interpretation of *síndhu-* just as ‘river’ or ‘ocean’ results patently far-fetched or simply impossible. In any case, for the Avestan corresponding form, *hiṇdu-/həṇdu-* (O.P. *hindu-*), no good Iranian or Indo-Iranian (independent) etymology seems to be recognizable, and it is presumable, as normally stated, that this one was a very early loanword in Iranian, just meaning not ‘India’, but ‘(natural) frontier’, and thus referring to barriers or obstacles as big and large as a river or a large basin of water (lake, sea or ocean). Here some problems connected with this interpretation of the linguistic data are analyzed, with special regard for the Indo-Iranian and Avestan mythology.

**Keywords** Frontier. Avestan. Vedic. Indo-Iranian. Indus.

In a very important article Paul Thieme demonstrated that Ved. *Síndhu-* was a nominal *-u-* formation, based on a non-attested present stem *\*sinadh-/sindh-* derived by a verbal root <sup>2</sup>*sidh* (usual present stem *sadha-*) (Thieme 1970, pp. 447-449).<sup>1</sup> Then, *\*sindhú-* would originally mean ‘warding off, keeping away’, while the corresponding substantivization as *síndhu-*, m./f., (with the stress on the root) meant ‘he/she who wards off, keeps away’, i.e. ‘natural frontier’. In spite of the evident absence of a present stem like *\*sinadh-/sindh-*, the reconstruction suggested by Thieme is still the most reasonable at the light of few R̥gvedic passages where the standard interpretation of *síndhu-* just as ‘river’ or ‘ocean’ results patently far-fetched or simply impossible. Thus, we can assume that only later it assumed the current values of ‘river’ (f.) and ‘sea, ocean’ (m.).<sup>2</sup>

1 Cf. also Mayrhofer 1976, p. 468 and 1996, pp. 729-730 (with additional bibliography on the subject), substantially supportive of Thieme’s analysis.

2 On the difference of gender see Thieme 1970, p. 447 n. 3, after Lüders 1951, 1, pp. 129-131.

In any case, for the Avestan corresponding form,<sup>3</sup> *hiṇdu-/həṇdu-* (O.P. *hi<sup>n</sup>du-*),<sup>4</sup> no good Iranian or Indo-Iranian alternative etymology seems to be recognizable,<sup>5</sup> and it is presumable, as normally stated, that this one was an ancient 'loanword' in Iranian, the meaning of which, just at the time of its acquisition, was not yet that of 'India', but still that of '(natural) frontier', thus referred to barriers or obstacles as big and large as rivers or wide basins of water (lake, sea or ocean) (Thieme 1970, pp. 448-449; cf. Karttunen 1995).

It must be considered that in the case of Av. *hiṇdu-/həṇdu-* Thieme did not properly like the denomination of 'loanword'; actually, he preferred to define it as an 'adaptation', and this because the Iranians, «when hearing the Indian name *Sindhu-* transposed it into sounds fully meaningful to an Iranian ear, as they transposed *Saptá Sindhavas* 'the Seven Rivers, the land of the Seven Rivers' (RV 8.24.27) – later (in the epic) simply *Sindhavas* 'the country between Indus and Sutlej' – into *Hapta Hindū* (sic) Vd.I.19» (1970, p. 450). This, however, was a minor problem, because in any case such a word entered the Iranian linguistic area from an Indo-Aryan speaking domain, while Thieme's dominant interest was clearly to solve a problem of linguistic chronology connected with such a loan or adaptation. In fact, according to an earlier remark made by Pisani (1962, p. 44) and later developed by Szemerényi (1966, pp. 192-193), the Iranian change *s > h* should have taken place «only after the Indus river and its Indian name *Sindhu-* had become known to Iranian speakers». But, while Szemerényi used this datum in order to show the lateness of that isogloss, which should be dated not before 1000 BCE – in another article Szemerényi preferred a period later than the eighth century BCE because of the argument that the name of Susa was in OP. *<sup>h</sup>Ujiya-*, etc., where initial *s > h* (Szemerényi 1966; contra Pisani 1969, p. 351 n. 1) – Pisani was convinced that such a linguistic phenomenon was older (chronologically earlier than the Aryan assibilation of Indo-European palatals) (see also Gusmani; 1972; cf. Boccali 1981, pp. 14-16), so that the presentation of the scholarly discussion in the brief article of Thieme did not properly describe the status of the debate in its whole complexity. In fact, it seems that both scholars agreed on the later dating of this linguistic change, while they strongly criticized each other in a number of articles.<sup>6</sup>

3 Bartholomae 1904, p. 1814. The orthography with *-ə-* instead of *-i-* is discussed by Bartholomae in note.

4 Brandenstein, Mayrhofer 1964, p. 125; cf. Kent 1953, p. 214. In Old Persian it is attested also *hi<sup>n</sup>duya-* '(Man) of Sind', 'Indian'.

5 On the contrary, Brunner (2006, p. 7) is convinced that the explanation given by Thieme (1970) supports the existence of an Indo-Iranian etymology, which is not true.

6 See Szemerényi 1966, 1968; Pisani 1967, 1969, p. 351. Cf. also Hintze 1998.

The etymological reconstruction and in particular that of the semantics to be originally ascribed to Ved. *síndhu-*, «certainly cannot be used to date the Iranian replacement of an older, inherited, *s* by *h*», as Thieme rightly underlined in conclusion of his article (1970, p. 450). I absolutely share his point of view, because an ancient word denominating ‘barrier, obstacle’ might have been adopted and then adapted, when Proto-Iranians and Proto-Indians were still moving towards their definitive historical locations.

What has to be additionally remarked concerns the evident fact that also in the Iranian framework we can reconstruct a reasonable chronology for the semantic development assumed by that interesting Iranian word of foreign origin. In Old Persian, *hi<sup>n</sup>du-* or *Hindu-<sup>7</sup>* actually refers to a country (*dahyu-*),<sup>8</sup> i.e. ‘India’, probably so named after the river, although a certain reminiscence of the earlier meaning of ‘extreme border’ could have been preserved in DPh 4-8, where king Darius I clearly mentioned the extreme cardinal points of his realm:

[(...) *θāti Dārayava.uš xšāyaθiya: ima xšačam, taya adam dārayāmi, hacā Sakaībiš, tayaī para Sugdam, amata yātā ā Kūšā, hacā Hindaū, amata yātā ā Spardā (...)*].<sup>9</sup>

King Darius says: This is the kingdom that I hold, from the Scythians who are beyond Sogdiana, thence unto Kūš (Nubia); from Sind, thence unto Sardis (Lidia).

This statement implies that after some centuries one of the lands located on the eastern frontier of the Iranian *plateau* was just named ‘Hindu’. But which was the ‘Avestan’ situation? I think that the *conspectus* of the sources needs a new examination. In the oldest passages where the stem *hiṇdu-/həṇdu-* occurs, it can be referred to a frontier, located farther with respect to the point of observation of an Iranian speaker. This is patent in Y. 57, 29:<sup>10</sup>

7 Mayrhofer remarked that O.P. *hi<sup>n</sup>du-* was not a direct loanword from Indo-Aryan languages, but an adaptation of an already Iranianized word (1971, p. 51 n. 41). Cf. Eilers 1977, pp. 288, 293.

8 In DPe 17-18, it is placed between Arachosia and Gandara; cf. Kent 1953, p. 136; Schmitt 2009, p. 118.

9 Transcription according to Schmitt 2009, pp. 119-120; cf. Kent 1953, pp. 136-137.

10 Cf. Kreyenbroek 1985, p. 55: «if (an evil-doer) is by the eastern frontier, he is caught, if he is by the western one, he is struck down». Cf. Dehghan 1982, p. 49: «sei es an der östlichen Grenze, wird er ergriffen, sei es an der westlichen, wird er niedergeschlagen».

*yaṭciṭ ušastaire hiṇduuō āgəuruuiete*<sup>11</sup>  
*yaṭciṭ daošataire niyne* [...].<sup>12</sup>

Pahl. Translation: *kē pad ošastar hindūgān gīrēd ud kē-z pad dōšastar nē zanēd* [*ud kē-z bē zanēd ā-z rasēd*] [...].

Av. Text: [...] that which he (Sraoša) seizes in the eastern frontier/limit, that which he slays in the western frontier/limit.<sup>13</sup>

Pahl. Tr.: the one that seizes Indians in the East, and the one, too, who does strike in the West [and the other one, who does strike, that also reaches its mark] [...].<sup>14</sup>

It is patent that *ušastaire hiṇduuō* cannot be interpreted as ‘eastern India’, as Bartholomae presumed, but that it concerned a general denomination of an ‘eastern frontier’. Actually, there is no reason to presume that a sinner might try to escape to eastern India in order to avoid Sraoša’s (or Miθra’s) punishment. In the second verse-line *yaṭciṭ daošataire niyne*, one should suppose an ellipsis for *yaṭciṭ daošataire <hiṇduuō> niyne*. Then, the expression in its totality simply evokes locations as far as possible with respect to the Iranian homeland, where an impious man could try to escape, although Sraoša should be able to find and slay him. Unfortunately, the Pahlavi translation of this passage is of minor interest, because the later scribe has not properly understood the text. Furthermore, on the meaning of the adj. *ušastara*-,<sup>15</sup> ‘towards the dawn’, ‘eastern’, as well as on that of *daoša(s)tara*-, ‘towards the evening (i.e. west)’, ‘western’,<sup>16</sup>

11 Reading according to F1 and Pt1; see Kellens 1984, p. 127, who follows Lommel 1922, pp. 203-204; cf. again Kellens 1984, p. 178 n. 3.

12 It is to be noted that these two verse-lines occur also in *Yt.* 10, 104 (cf. Gershevitch 1967, pp. 124-125, 253); Markwart, presumed that these lines (as those of *Y.* 57, 29) should belong to a lost Avestan text about rivers (1938, p. 133).

13 See now Kellens 2011, p. 96 «celle qu’il saisit à la limite du levant et celle qu’il abat à la limite du ponant». Thieme translated this passage as follows: «even when he (a man) is in the East of the [eastern] frontier [of the inhabited world, or, of the Aryan country] he is seized [by Sraoša], even when he is in the west [of the western frontier] he is slain» (1970, p. 449). It is clear that Thieme took *hiṇduuō* as a genitive, but, as explained by Humbach, this is a locative sg. (1959, p. 21); cf. also Dehghan 1982, pp. 94-95.

14 Text and translation according to Kreyenbroek 1985, pp. 54-55, for the commentary on the Pahlavi text see again Kreyenbroek 1985, p. 94.

15 Bartholomae 1904, p. 415.

16 Bartholomae 1904, p. 674. Cf. Dehghan 1982, p. 96 n. 13.

there is no discussion,<sup>17</sup> so that we may conclude that both adjectives do not refer to the opposite sides of India, but simply to the farthest eastern and western frontiers.

In *Yt.* 8, 32, we find a particular mountain, which is located in the centre of the Sea Vourukaša; it was named *Us.hiṇḍauua*:-<sup>18</sup>

<p><i>us paiti adāt̄ hištaiti</i>  <i>spitama zaraθuštra</i>  <i>tištriio raēuuā xʷarənaŋvḥā</i>  <i>zraiiŋhaṭ̄ haca vourukašāt̄</i>  <i>us adāt̄ hištāt̄</i>  <i>satauuāēsō raēuuā xʷarənaŋvḥā</i></p>	<p>From this moment,          Spitama Zaraθuštra,          the bright <i>xʷarənah</i>-endowed Tištriia          rises again from the Sea Vourukaša.          From this moment          the bright <i>xʷarənah</i>-endowed          Satauuāēsa will rise</p>
<p><i>zraiiŋhaṭ̄ haca vourukašāt̄</i>  <i>āṭ̄ taṭ̄ dunmān hqm.hištənti</i>  <i>us hiṇḍauuaṭ̄<sup>19</sup> paiti garōiṭ̄</i>  <i>yō hištaite maiḍim</i>  <i>zraiiŋhō vourukašāhe.</i></p>	<p>from the Sea Vourukaša.          Then, the mists will gather          on Mount <i>Us.hiṇḍauua</i>,          which stands in the middle          of the Sea Vourukaša.</p>

Thieme assumed that the original meaning of the name of this mountain cannot be that of 'situated beyond India' (as again it was stated by Bartholomae),<sup>20</sup> but that of 'beyond the natural frontiers', with a close reference to the mountain range encircling the Sea Vourukaša, according to the ancient Iranian cosmography. On the other hand, this solution is puzzling, because the same mountain, according to *Yt.* 8, 32, is not located 'beyond' the Sea Vourukaša, but it should stand exactly in its centre. So, if we maintain the basic meaning of *us°/uz°*,<sup>21</sup> i.e. 'up', as most presumable, *us.hiṇḍauua*- could simply mean 'up(permost)-barrier'. A similar suggestion was already expressed by Bailey, when he proposed a translation of that name as «high place» or «with up-soaring height» (1975a; 1975b). In my commentary to the *Tištār Yašt* I rejected this interpretation, because the meaning assumed by Bailey seemed too close to that of *Av. gairi*-, m. 'mountain',<sup>22</sup> but, on the other hand, there is no semantic reason against the possibility that a mountain was de-

17 For the adversative function of *-tara-* see Debrunner in Wackernagel - Debrunner 1954, p. 603; cf. also Benveniste 1948, pp. 118-119.

18 Text and translation according to Panaino 1990, p. 56. In Pahlavi this name appears as *Usind*, *Usindam*, *Usindum*; see Bailey 1975, p. 611.

19 I prefer this reading based on the MS J10 rather than *us.həṇḍauuaṭ̄* in Panaino 1990, p. 56.

20 Cf. Bartholomae 1904, p. 409. See also Markwart 1938, pp. 132-133.

21 Cf. Bartholomae 1904, pp. 404-405.

22 Cf. Panaino 1990, p. 119, and Gnoli 1980, pp. 55-56 n. 245. On the mountains in Avestan literature and Mazdean sources and their mythology see Panaino 2010.

nominated as ‘The Up(per)-Barrier’,<sup>23</sup> in particular a mountain’s peak that dominated the centre of the Sea Vourukaša (cf. Gnoli 1967, p. 29), where the mists gathered before the arrival of rains.

The textual data attested in *Vd.* 1, 18 and its Pahlavi commentary present an additional number of interesting problems and they need a more detailed discussion.

*Vd.* 1, 18: *pañcadasəm asaḡhamca šōiθranəmca vahištəm frāθβərəsəm azəm yō ahurō mazdā yō hapta.həṇdu. āaṭ ahe paitiiārəm frākərəntaṭ aḡrō mainiiuš pouru.mahrkō araθβiiāca daxšta araθβīmca garəmāum.*

I who am Ahura Mazdā sharpened the fifteenth one, the best one among the places and the lands, Hapta.həṇdu. But, Aṅra Mainiiu (being) very mortiferous fashioned its (antagonistic) calamity, irregular menses and abnormal (or ‘unsuitable’) heat.<sup>24</sup>

An Avestan quotation is embedded in the Pahlavi translation of the same passage; it runs as follows:<sup>25</sup>

*u-š haft-hindūgānih ēd kū sar-xwadāy haft ast: ēd-iz rāy nē gōwēm kū haft rōd čē ān-iz az abestāg paydāg: **haca ušastara hiṇduua auui daošastarəm hiṇdūm.** ast kē ēdōn gōwēd har kišwar-ēw ēk ast.*

Its being *Haft-Hindūgān* is this that it has seven lords. For this reason, I do not say that (it means/has) ‘seven rivers’! Because that is clear from the *Avesta*: [*haca ušastara hiṇduua auui daošastarəm hiṇdūm*]. There is one who says thus: «Every climate is one».

In the first chapter of the *Widēwdād*, where we find a description of the Ahurian lands, the reference to *Hapta.həṇdu*- doubtless concerns northern India, more precisely the Puñjāb.<sup>26</sup> We must remark that this region was

23 Although Gnoli (*ibidem*) rightly criticized Bailey’s interpretation of *saptá síndhavas* as ‘The Seven High Places’, I must remark that in the case of the Pahlavi gloss to *Vd.* 1, 18, where the denomination of *haft hindūgānih* is explained with reference to its ‘seven captains’ (*ēd kē sar-xwadāy haft ast*), we must consider that this source clearly reflects a later development of the meaning attributed to *hapta.həṇdu*-, so that it cannot be taken as a compelling representative of its earlier semantic value; furthermore, my revision of the interpretation of the meaning of *us.hiṇdauua*- is based on the presence of *us*°. Then, it does not concern the simple form *hiṇdu-/həṇdu*-.

24 See also Panaino 2009, p. 193.

25 See Dehghan 1982, p. 95. Anklesaria 1949, pp. 19-20; Moazami 2014, pp. 40, 41.

26 Gnoli 1967, pp. 68, 76-77; 1980, pp. 47-48, 50-53, 63-64, with a detailed discussion of the geographical, historical, and religious problems connected to this passage of the *Widēwdād*.

regarded as belonging to the best (*vahišta-*) countries created by Ahura Mazdā, and inhabited by Aryan peoples. In this case it is difficult to believe that its essential meaning was still that of 'frontier'. Furthermore, in the Avestan quotation of the Pahlavi *Widēwdād*, *hindūgān* is interpreted as 'chief, lord' and not as 'river'; then, it seems that the Avestan sentence could be even understood as «from the (land of the) eastern lord towards (the one of the) western lord», and no more as «from the eastern frontier to the western frontier», as translated by Anklesaria (1949, p. 20), based on the traditional correspondence between Skt. *sindhu-* as 'river', Av. *hiṇdu-* and Pahl. *rōd* 'river'. In any case, that neither 'chief' nor 'river' were the original meaning is shown by the passage of Y. 57, 29, *yaṭciṭ ušastaire hiṇduuō āgēuruuiete yaṭciṭ daošataire <hiṇduuō> niyne*, attested also in *Mihr Yašt*, st. 104.<sup>27</sup> In my opinion, the quotation *haca ušastara hiṇduua auui daošastarēm hiṇdūm*, is based on these traditions, although the passage, as it appears in the Pahlavi *Widēwdād*, is not attested otherwise in the extant Avestan tradition. In spite of the later gloss of the Pahlavi scribe, it is probable that in Sasanian and later times, both Y. 57, 29 and Yt. 10, 104 were interpreted at the light of the equation between Skt. *sindhu-* as 'river' and Pahl. *rōd* 'river'. But this is, of course, what we must expect after so many centuries. However, we must insist on the fact, already underlined by Gnoli (1967, pp. 76-77; 1980), that there is no reason to consider the correspondence between Hapta.Həṇdu and Saptá Síndhavas as being based on a common ancestral mythical geography.

Dehghan noted that in general *Hindūgān* should not properly mean 'India', but it must be referred to the 'Indus river' (1982, p. 95, with reference to Humbach 1973), as in the *Ir.Bd.* 11, 8: [...] *ud mihrān rōd kē hindūgān rōd-iz xwānēnd* [...] «[...] the river Mihrān [which] they also call the river Hindus [...]».<sup>28</sup> On the other hand, we have seen that in the Pahlavi translation of Y. 57, 29, *hindūgān* is used with reference to the 'Indian people', and that *Hind* and *Hindūg* are common designation for 'India' and 'Indian(s)' (the second both as adjective and substantive) (MacKenzie 1971, p. 43; Nyberg 1974, p. 100).

It is important to recall that, according to Humbach, the Pahlavi explanation of the *Widēwdād* passage in 1, 18, was based on a wrong identification of *Hapta.həṇdu-*, which was current among eastern Mazdeans (1973, pp. 51-52). This mistake is already emphasized by al-Bīrūnī in his book about India (*Ketāb taḥqīq mā le'l-Hend men maqūla maqbūla fi'l-'aql aw marqūla* «The book confirming what pertains to India, whether rational or despicable»), where it is stated:

27 Gershevitch 19, pp. 125, 126: «if (the violator is) by the eastern river he is caught, if (he is) by the western (river) he is struck down». Cf. also Kellens 1979.

28 See Pakzad 2005, pp. 149-150. Cf. Anklesaria 1956, pp. 106-107.



As the name 'union of the five rivers' [i.e. Panjāb] occurs in this part of the world, we observe that a similar name is used also to the north of the above-mentioned mountain chains [i.e. Hindukush], for the rivers which flow thence towards the north, after having united near Tirmidh and having formed the river of Balkh, are called the 'union of the seven rivers'.

The Zoroastrians of Sogdiana have confounded these two things; for they say that the whole of the seven rivers is Sind and its upper course Barīdiš (Al-Bīrūnī, ed. Sachau 1887, p. 130: tr. by Sachau 1888 [= 1910], 1, p. 260).<sup>29</sup>

But we must also observe that Gnoli rejected the association of *Hapta. həṇdu-* with a mountainous region located at north-east of the Hindūkuš (1980, p. 53 n. 231). In fact, the mistaken denomination is attributed only to the 'Zoroastrians of Sogdiana', not to all the Mazdeans. Furthermore, the mention in the Avestan passage of an «unsuitable» or «abnormal heat» as the main negative character of the corresponding Ahrimanic contra-creation (*paitiiāra-*) does not seem to fit with a mountainous country, in spite of the fact that this phenomenon could be in part of symbolic nature.<sup>30</sup>

Finally, it is interesting to note again that the name of the 'Land of the Seven Rivers' was not only connected with the presence of 'seven lords' (although no pseudo-etymological game of popular origin seems to me possible in this case), but also with the image of the seven 'climes' (*kišwar*) of the world (as noted by Brunner 2006, p. 7), so that each *kišwar* should have its own chief. I must recall that in the case of names presenting the numeral seven as the first member of the compound a certain preference for popular etymology is attested also in the name of one very important Avestan constellation: *haptōiriṅga-*, m., 'the seven signs' (or, perhaps 'the seven penises' (cf. Skt. *liṅga-*) (Kellens 2010, p. 756 n. 21). Its Pahlavi denomination, *haftōring*, was interpreted in *Ir.Bd.* 2, 9 (see Pakzad 2005, pp. 38-39), as *haft rag* 'having seven veins/cords', each one in connection with one of the corresponding seven *kišwar* of the earth, in the framework of an astral cosmology that, in its turn, is of Indian origin.<sup>31</sup>

---

29 On this passage see Markwart 1938, pp. 94-96, 132-133. Cf. Dehghan 1982, p. 95.

30 On the other hand, we must consider that in the case of Raḡhā, the Ahremanic counter-creation is that of the 'winter created by the demons', which seems to have a climatic and geographic correspondence in the *realia*; see Gnoli 1980, pp. 52-53. For a general discussion of these problems also with regard to the studies offered by various scholars on the subject and by Monchi-Zadeh (1975) in particular, see again Gnoli 1980.

31 On this subject see Panaino 1998, pp. 71, 77, 99, with bibliography.



## Bibliography

- al-Bīrūnī, Abū Rayḥān (1887). *Kitāb taḥqīq mā li'l-Hind min maqūlat maqbūla fi al-'aql aw marḍūlat - Alberuni's India: An Account of the Religion, Philosophy, Literature, Geography, Chronology, Astronomy, Customs, Laws and Astrology of India about A.D. 1030*. 2 vols. Ed. in the Arabic Original by Edward C. Sachau. London; Göttingen: Trübner.
- al-Bīrūnī, Abū Rayḥān (1888). *Alberuni's India: An Account of the Religion, Philosophy, Literature, Geography, Chronology, Astronomy, Customs, Laws and Astrology of India about A.D. 1030*. 2 vols. An English ed. with notes and indices by Edward C. Sachau. London: Trübner. Repr. 1910.
- Anklesaria, Behramgore Tehmurasp (1949). *Pahlavi Vendidād (Zand-ī Jvīṭ-Dēv-Dāt)*. Transliteration and translation in English. Bombay: K. R. Cama Oriental Institute.
- Anklesaria, Behramgore Tehmurasp (1956). *Zand-Ākāsīh, Iranian or Greater Bundahišn*. Transliteration and translation in English. Bombay: published for the Rahnumae Mazdayasnan Sabha by its Honorary Secretary Dastur Framroze A. Bode.
- Bartholomae, Christian (1904). *Altiranisches Wörterbuch*. Straßburg: Trübner.
- Bailey, Harold Walter (1975a). «The Second Stratum of the Indo-Iranian Gods». In: Hinnells John R. (ed.), *Mithraic Studies*. [Manchester]: Manchester University Press, pp. 1-20
- Bailey, Harold Walter (1975). «Indian *Sīndhu-*, Iranian *Hindu-*». *BSOAS*, 38, pp. 610-611.
- Benveniste, Emile. (1948). *Noms d'agent et noms d'action en Indo-européen*. Paris: Adrien Maisonneuve.
- Boccali, Giuliano (1981). «L'antico persiano». In Campanile, Enrico (a cura di), *Nuovi Materiali per la Ricerca Indeuropèistica*. Pisa: Giardini, pp. 11-23.
- Brandenstein, Wilhelm; Mayrhofer, Manfred (1964). *Handbuch der Altpersischen*. Wiesbaden: Otto Harrassowitz.
- Brunner, Christopher J. (2006). «India. i. Introduction». In *Encyclopædia Iranica*, vol. 13. Ed. Ehsan Yarshater. London; Boston: Routledge & Kegan Paul, pp. 6-8.
- Dehghan, Keyvan (1982). *Der Avesta-Text Srōš Yašt (Yasna 57) mit Pahlavi und Sanskritübersetzung* (MSS, Beiheft 11, N.F.). Munich: Kitzinger.
- Eilers, Wilhelm (1977). «Einige Prinzipien toponymischer Übertragung». *Onoma*, 21, pp. 277-317.
- Gershevitch, Ilya (1956). *The Avestan Hymn to Mithra with an Introduction, Translation and Commentary*. Cambridge: Cambridge University Press. 2nd ed. 1967.
- Gnoli, Gherardo (1967). *Ricerche Storiche sul Sīstān antico*. Roma: Istituto Italiano per il Medio ed Estremo Oriente.

- Gnoli, Gherardo (1980). *Zoroaster's Time and Homeland*. Napoli: Istituto Universitario Orientale.
- Gusmani, Roberto (1972). «A proposito del passaggio  $s > h$  in iranico, greco ecc.». *Archivio Glottologico Italiano*, 57, pp. 10-23.
- Hintze, Almut (1998). «The Migrations of the Indo-Iranians and the Iranian Sound-Change  $s > h$ ». In: Meid, Wolfgang (ed.), *Sprache und Kultur der Indogermanen. Akten der X. Fachtagung der Indogermanischen Gesellschaft, Innsbruck, 22.28. September 1996*. Innsbruck: Institut für Sprachwissenschaft der Universität Innsbruck, pp. 139-153. *Innsbrucker Beiträge zur Sprachwissenschaft* 93.
- Humbach, Helmut (1959). *Die Gathas des Zarathustra*. Bd. 1. Einleitung. Text. Übersetzung. Paraphrase. Heidelberg: C. Winter.
- Humbach, Helmut (1973). «Al-Biruni und die sieben Strome [sic] des *Awesta*». *Bulletin of the Iranian Culture Foundation*, 1 (2), pp. 47-52.
- Karttunen, Klaus (1995). «The Name of India». In: Galewicz, Cezary; Czerniak-Drozdowicz, Marzenna (eds.), *International Conference on Sanskrit and Related Studies, September 23-26, 1993*. Crakow: The Enigma Press, pp. 151-164. *Crakow Indological Studies* 1, 1.
- Kellens, Jean (1979). «Le bras de Miθra». In: Ugo Bianchi (a cura di), *Mysteriae Mithrae = Atti del Seminario Internazionale su «La Specificità Storico-Religiosa dei Misteri di Mithra, con Particolare Riferimento alle Fonti Documentarie di Roma e Ostia»* (Roma, Ostia 28-31 marzo 1978). Leiden: Brill, pp. 703-716. *Études préliminaires aux religions orientales dans l'Émpire romain* 80.
- Kellens, Jean (1984). *Le verbe avestique*. Wiesbaden: Ludwig Reichert Verlag.
- Kellens, Jean (2010). *Études avestiques et mazdéennes*, vol. 4, *L'acmé du sacrifice: Les parties récentes des Staota Yesniia (Y27.13-Y59) avec les intercalations de Visprad 13 à 24 et la Dahmā Āfriti (Y60-61)*. Paris: De Boccard. Persica 16.
- Kellens, Jean (2011). «La notion d'âme préexistante». En *Langues et religions indo-iraniennes: Résumé des Cours. Annuaire du Collège de France*. Paris: Collège de France, pp. 747-762.
- Kent, Roland G. (1953). *Old Persian Grammar, Texts, Lexicon*. 2nd ed. New Heaven: American Oriental Society.
- Kreyenbroek, Philip G. (1985). *Sraoša in the Zoroastrian Tradition*. Leiden: Brill.
- Lommel, Herman (1922). «Untersuchungen über die Metrik des jüngeren *Awesta*». *Zeitschrift für Indologie und Iranistik*, 1, pp. 186-245.
- Lüders, Heinrich (1951). *Varuṇa*, Bd. 1, *Varuṇa und die Wasser*. Göttingen: Vandenhoeck & Ruprecht.
- MacKenzie, David Neil (1971). *A Concise Pahlavi Dictionary*. London: Routledge Curzon.

- Markwart, Josef (1938). *Wehrot und Arang: Untersuchungen zur mythischen und geschichtlichen Landeskunde von Ostiran*. Hrsg. von H.H. Schaeder. Leiden: Brill.
- Mayrhofer, Manfred (1971). «Neuere Forschungen zum Altpersischen». In: Schmitt-Brandt, Robert (Hrsg.), *Donum Indogermanicum: Festgabe für Anton Scherer*. Heidelberg: C. Winter, pp. 41-56.
- Mayrhofer, Manfred (1976). *Kurzgefaßtes etymologisches Wörterbuch des Altindischen - A Concise Etymological Sanskrit Dictionary*. Bd. 2., Lieferung 20. Heidelberg: C. Winter.
- Mayrhofer, Manfred (1996). *Etymologisches Wörterbuch des Altindischen - A Concise Etymological Sanskrit Dictionary*. Bd. 3 (Y-H). Heidelberg: C. Winter.
- Moazami, Mahnaz (2014). *Wrestling with the Demons of the Pahlavi Widēwdād*. Transcription, translation and commentary. Leiden: Brill.
- Monchi-Zadeh, Davoud (1975). *Topographisch-historische Studien zum iranischen Nationalepos*. Wiesbaden: Steiner.
- Nyberg, Henrik Samuel (1974). *A Manual of Pahlavi*, Bd. 2. Wiesbaden: Harrassowitz.
- Pakzad, Fazlollah (2005). *Bundahišn: Zoroastrische Kosmogonie und Kosmologie*, Bd. 1, *Kritische Edition*. Tehrân: Markaz-i Dâ'irat al-Ma'ârif-i Buzurg-i Islâmî, 1384.
- Panaino, Antonio (1990). *Tištrya*, part 1, *The Avestan Hymn to Sirius*. Roma: Istituto Italiano per il Medio ed Estremo Oriente.
- Panaino, Antonio (1998). *Tessere il cielo: Considerazioni sulle Tavole astronomiche, gli Oroscopi e la Dottrina dei Legamenti tra Induismo, Zoroastrismo, Manicheismo e Mandeismo*. Roma: Istituto Italiano per l'Africa e l'Oriente.
- Panaino, Antonio (2009). «Avestan *daxta-* and *ciθra*, I, The Semantic Field: Female Germen and Menstruation». In: Pirart, Eric; Tremblay, Xavier (éds.), *Zarathushtra entre l'Inde et l'Iran: Études indo-iraniennes et indo-européennes offertes à Jean Kellens à l'occasion de son 65e anniversaire*. Wiesbaden: Ludwig Reichert Verlag, pp. 186-208.
- Panaino, Antonio (2010). «Sacertà delle montagne e metafisica della luce nella cosmografia iranica mazdaica». In: Grossato, Alessandro (a cura di), *La Montagna cosmica*. Milano: Medusa, pp. 43-67.
- Pisani, Vittore (1962). *Storia della Lingua Latina*. Torino: Rosenberg & Sellier.
- Pisani, Vittore (1967). «Zum Wandel *s* > *h* im Iranischen und im Griechischen». *Die Sprache*, 13, pp. 206-207.
- Pisani, Vittore (1969). «Festschrift für Wilhelm Eilers. Ein Dokument der internationalen Forschung zum 27. September 1966. Wiesbaden, 1967»; «„Festgabe für Wilhelm Eilers“». *Die Sprache*, 12 (2), 1966, pp. 113-288 [Reviews]. *Paideia*, 24, pp. 349-352.

- Schmitt, Rüdiger (2009). *Die altpersischen Inschriften der Achaimeniden: Editio minor mit deutscher Übersetzung*. Wiesbaden: Ludwig Reichert Verlag.
- Szemerényi, Oswald (1966). «Iranica II». *Die Sprache*, 12, pp. 192-226.
- Szemerényi, Oswald (1968). «The development  $s > h$  in Indo-European languages». *Die Sprache*, 14, pp. 161-163.
- Thieme, Paul (1970). «Sanskrit *sindhu-/Sindhu-* and *hindu-/Hindu-*». In: Boyce, Mary; Gershevitch, Ilya (eds.), *W.B. Henning Memorial Volume*. London: Lund Humphries, pp. 447-450.
- Wackernagel, Jacob; Debrunner, Albert (1954). *Altindische Grammatik*. Bd. 2, 2, *Die Nominalsuffixe* (von A. Debrunner). Göttingen: Vandenhoeck und Ruprecht.

## Borders

Itineraries on the Edges of Iran

edited by Stefano Pellò

# Arabic *ḥadd* in Iranian

## Notes on Some Cases of Grammaticalization

Ela Filippone

(Università degli Studi della Tuscia, Italia)

**Abstract** Arabic *ḥadd* – whose primary sense is that of ‘cutting edge’ – is a highly polysemic word which belongs to the Semitic root ḤDD and conveys the broad idea of ‘edge’ and ‘limit’. A well integrated term in many contexts of the Islamic cultural area (i.e. Persian, Turkish, Urdu, Hindi, Kashmiri, Marathi, Malay, etc.), Ar. *ḥadd* generally maintained the status of a polysemic word in the target languages, characterizing different semantic domains and different registers. Here the ecology of borrowings from Ar. *ḥadd* in the Iranian languages, where it is already recorded in Choresmian and Early New Persian, is examined. While describing some interesting cases of grammaticalization, semantic bleaching and semantic extensions, an extensive array of linguistic spaces will be excavated, suggesting as well a possible alternative hypothesis for the presumed extinction of the lexical set of OPrs. *ḥadiš-*.

**Summary** 1 Arabic *ḥadd*. – 2 Arabic *ḥadd* in the Iranian Languages. – 3 Some Cases of Grammaticalization. – 4 Final Remarks.

**Keywords** Iranian Studies. Iranian Dialectology. Arabic Dialectology. Loanwords. Grammaticalization.

### 1 Arabic *ḥadd*

Arabic *ḥadd* is a highly polysemic word. To have an idea of how great its semantic range is, suffice it to consider the complexity of the relevant lexical entries in the Arabic dictionaries (both bilingual and monolingual). Consider, for example, the (English and Italian) equivalents for *ḥadd* (pl. *ḥudūd*) provided in (1) Lane 1863-1893, s.vv. *ḥadd* and *ḥadda* (this latter sharing with the former some of its senses), (2) Wehr 1979, where two separate entries *ḥadd* are organized on the basis of different morphological behaviour and (3) VAI 1966-1973:

(1) (Lane 1863-1893)

*ḥadd* prevention, hinderance, impediment, withholding, restraint, debarring, inhibition, forbiddance, prohibition, interdiction [...]; a restrictive ordinance, or statute, of God, respecting things lawful and things unlawful [...] The *ḥudūd* of God are of two kinds: first, those ordinances

prescribed to men [...] the second kind, castigations, or punishments [...] the first kind are called *ḥudūd* because they denote limits which God has forbidden to transgress: the second, because they prevent one's committing again those acts for which they are appointed as punishments; bar, obstruction, partition, separation [...] between two things or between two places [...], or between two persons [...] to prevent their commixture, or confusion, or the encroachment of one upon the other; limit, boundary of a land or a territory [...]; (in Logic) definition [...]; end, extremity or utmost point [...]; the edge, or extremity of the edge, and point of anything as a sword, a knife, a spear-head or an arrow [...]; side, region, quarter or tract [...]; station, standing, rank, condition or the like [...]; case [...] class, category [...]; a quarter of the year [...]

*ḥadda* a man's sharpness, penetrating energy, or vigour, in the exercise of courage; his mettle; [...] his valour, or valiantness in war [...] *ḥadd* and *ḥadda* as denoting a quality of anything are syn. [both signify sharpness; vehemence; force; strength and both the force, or strength, of wine and the like [...]]

(2) (Wehr 1979)

*ḥadd* prevention, limitation; restriction (of the number or quantity of s.th.)  
*ḥadd* (pl. *ḥudūd*) cutting edge (of a knife, of a sword); edge, border, brink, brim, verge; border (of a country), boundary, borderline; limit (fig.), the utmost, extremity, termination, end, terminal point, terminus; a (certain) measure, extent, or degree (attained); (*math.*) member (of an equation), term (of a fraction, of a proportion); divine ordinance, divine statute; legal punishment (*Isl. law*)

(3) (VAI 1966-1973)

*ḥadd* confine, frontiera, limite, termine; estremità, orlo, ciglio; misura, grado raggiunto; punta, cima aguzza; taglio, filo (di coltello, spada, ecc.); termine di un sillogismo; termine planetario (*astrol.*); membro (di un polinomio, di un'equazione, ecc.); definizione; pena stabilita dal Corano; *ḥudūdu Allāhi* i limiti, le restrizioni imposte da Dio alla libertà d'azione dell'uomo.

A comparison between these three dictionary entries highlights some differences. Some senses are recorded in only one of the dictionaries taken into consideration. Lane 1863-1893, for example, makes no mention of the notion MEASURE; both Lane 1863-1893 and Wehr 1979 lack the reference to the astronomical meaning while there is no trace of 'force' and 'vigour' in Wehr 1979 and VAI 1966-1973.

The primary sense of Ar. *ḥadd*, a word which belongs to the Semitic root ḤDD, is that of 'cutting edge', thence 'edge, limit'.<sup>1</sup> It enhances the notion BOUNDEDNESS and around this notion, a category of related senses has developed,<sup>2</sup> including several important technical ones.

In the Islamic literature, *ḥudūd* (pl.) has become the term to designate the restrictive ordinances of God. In a religious and juridical sense, *ḥadd* refers to the punishment for serious crimes (in particular the class of punishments that are fixed for the crimes considered to be 'crimes against the religion'). But *ḥadd* has also become a technical term in many other branches of knowledge (like philosophy, ethics, logic, mathematics, astrology, etc.). The matter is of particular relevance, but is not at issue in this paper.<sup>3</sup>

In the Medieval Muslim geography, Ar. *ḥadd* is one of the several terms with which some kind of boundary was denoted.<sup>4</sup> Sometimes it was used by geographers with reference to political boundaries (generally between polities with hostile relationships), but mostly it was used with the sense of 'the end of anything' (in particular, geographical entities like countries, cities, lands, etc.). In a political sense, *ḥudūd* (pl.) mainly occurred in the description of the confines of specific regions within the Islamic realm and with it «a frontier zone enveloping a central core in the same sense as the cartographers' symbols, rather than a boundary line of demarcation defining a realm within which the power of the central government is felt uniformly» was generally meant (Brauer 1995, pp. 12-14).

The notion LIMIT conveyed by Ar. *ḥadd* favoured semantic bleaching and context generalization. Consequently, this word frequently occurs in phrasal units having a relational value, such as *li-ḥaddi* or *ila ḥaddi* 'until, till, up to, to the extent of', *ala ḥaddi* 'according to, commensurate with', *fī ḥudūdi* 'within, within the framework of', etc.

Due to its strong cultural and ideological implications, Ar. *ḥadd* rapidly gained ground all over the Islamic world, and is nowadays a well integrated word in many languages of the Islamic cultural area (i.e., Persian, Turkish, Urdu, Hindi, Kashmiri, Marathi, Malay, etc.). In the target languages, borrowings from Ar. *ḥadd* generally maintained the status of polysemic words, characterizing different semantic domains and different registers (both everyday language and technical languages, with different degrees of technicality).

1 Words for 'edge' are often etymologically connected with adjectives for 'sharp' or verbs for 'cut'; for IE see Buck 1949, p. 859.

2 Cf. Bron, Cohen, Lonnet 2010, p. 834. A different view is in Zammit 2002 p. 135, where three separate roots are listed: 1) ḤDD for Qur. Ar. *ḥudūd* 'prescribed limits' (connected to Epigraphic South Arabic *ḥdd* 'to sacralise'?); 2) ḤDD, for Qur. Ar. *ḥidād* (adj. pl.) 'sharp' (and several cognates); 3) ḤDD for Qur. Ar. *ḥadīd* 'iron'.

3 For general information cf. Goichon 1971, pp. 20-22.

4 A list of these terms is in Brauer 1995, pp. 11-12 fn. 18.



## 2 Arabic *ḥadd* in the Iranian Languages

In Iranian, Ar. *ḥadd* penetrated very early, as is evidenced by its being recorded in Choresmian (see *ḥd* ‘Grenze; durch den Coran vorgeschriebene Strafzumessung’ in Benzing-Taraf 1983). In Persian it is recorded since the earliest phases of this language (i.e., Early New Persian); in the *Šāhnāme* it already appears naturalized (with loss of the final gemination in case of bare nouns) in accordance with the Persian phonemic structure (cf. Moïnfar 1970, p. 67).

As an illustration of the treatment of Prs. *had(d)* and its plural form *hodud* in lexicography, I quote in what follows the relevant dictionary entries<sup>5</sup> from (1) Mo‘in 1992; (2) Haim 1992; (3) Lazard 1990:

(1) (Mo‘in 1992)

*had(d)* (1) obstruction between two things [hāyel-e miyān-e do čiz]; (2) edge of something, border, limit [kenāre-ye čizi, entehā, kerāne, marz], like that of a field [ex.: *yek ḥadd-e in mazra‘e rud ast* «one of the borders of this field is the river»]; (3) edge (of a scimitar or similar) [tizi (šamšir va mānande ān)] [...]; (4) measure [andāze] [...]; (5) (religious jurisprudence) for any crime for which there is a decreed punishment, there is a penalty which Islam has established with fixed texts, and this corporal punishment and its measure are definite, i.e., it does not have a minimum and a maximum [...]; (6) (logic) definition [...], etc.  
*hodud* (1) measures [andāzehā] [...]; (2) directions, edges, borders [suyhā, karānehā, marzhā]; (3) customs [āyyinhā, ravešhā]

(2) (Haim 1992)

*hadd, had* (1) limit; (2) boundary; (3) extent, measure; (4) penance, punishment by the lash; (5) Log. term, also definition; (6) goal; (7) (Rare) bar, impediment; (8) (Rare) edge  
*hodud* boundaries, bounds, confines, frontiers, limits; definitions, terms; rules, laws // whereabouts // neighborhood, vicinity // regions

5 For convenience, the glosses defining Persian and other Iranian words drawn from dictionaries whose exit language is Persian or Russian have been translated into English; the original gloss in transcription has been added into square brackets only when considered as relevant to the discussion or useful to avoid misunderstanding. Persian is transcribed (not transliterated), according to Lazard 1990 (with minor divergences). A tendentially phonemic transcription has been used for Balochi; for all the other Iranian languages, I have conformed with the systems used by the individual authors of the written sources from which any single expression has been extrapolated (always mentioned into brackets). In source references, the number of page is not given when the work is (or contains a section which is) alphabetically ordered. The following abbreviations have been used: Ar. = Arabic; Bal. = Balochi; Kurd. = Kurdish; Prs. = Persian; (Zor.) Yzd. = (Zoroastrian) Yazdi; (Zor.) Kerm. = (Zoroastrian) Kermāni.



(3) (Lazard 1990)

*had(d)*<sup>1</sup> (pl. *hodud*) limite, borne // étendue, mesure // log. définition // pl. *hodud* région, voisinage, environs

*had(d)*<sup>2</sup> anc. pénitence par le fouet; *had zadan* (*be* ou *rā*) infliger le fouet (à).

The phraseology provided in the Persian dictionaries is rich and includes many idioms of current usage. Some of these find their motivation in the idea that a *had(d)* marks the space which pertains to and characterizes any single individual, the «sphère de chacun» (cf. Desmaisons 1908, s.v.) in a concrete and figurative sense (including the sphere of authority, competence, responsibility, possibility, action, etc.): *az hadd-e xod taǰāvoz kardan* or *az had(d) (dar) gozaštan* 'to exceed (one's own) limits', *az had(d) birun budan* 'to be beyond limit', etc., all point to transgressive, blameworthy behaviours.<sup>6</sup>

Other common idioms are *hadd-e boluy* '(age of) puberty, full-age', *had(d) zadan* 'to administer a legal punishment to (a person) by the lash',<sup>7</sup> *hadd-e aqal* 'minimum', *hadd-e aksar* 'maximum', *tā hadd-i ke, be hadd-i ke* 'to the extent that, as far as', etc.

Ar. *ḥadd* was borrowed in Persian and in other Iranian languages and dialects mainly in its original uses, though not homogeneously, or at least not consistently; it is self-explanatory, for example, that some technical senses have only found their way into target languages with a literary tradition.

Both senses 'limit/border' and 'measure, extent' have proved to be fairly stable: cf. Afghanian Prs. (*h*)*ad* 'limite' (Bau 2003), Sistāni *had* 'measure, boundary' (Afšār Sistāni 1986), Kurmanji Kurdish *ḥed* (also *ḥedd, hed*) 'border, limit, frontier, boundary (*ḥed û sed* 'obstacles and barriers'); (legal) right' (Chyet 2003), Southern Kurdish *had* 'measure; degree, rank; boundary' (Hažār 1990, p. 228, written with initial ح), *had* 'suitability, appropriateness [hadd-e liyāqat, šāyastegi]; boundary; measure' (Hažār 1990, p. 965, written with initial o), Lori *had* 'measure; boundary' (Izadpanāh 2001), Balochi *hədd* 'border, limit' (see also below), Tāleši *həd* 'border; edge' (Pirejko 1976), Gilaki *hadd* 'border' (Kerimova, Memedzade, Rastorgueva 1980), Qohrudi *hadd* 'limite' (Lecoq 2002, p. 646), Waxi *ad* 'boundary, edge; measure' (Grjunberg, Steblin-Kamenskij 1976), Yaghnobi *xad* 'border, limit' (Andreev, Peščereva 1957), Pashto *hadd* 'boundary, extent, limit, extremity; impediment; definition; starting post; lashes inflicted for certain crimes, prescribed by the laws of Islam' (Raverty 1860), etc. As for Pashto, Aslanov (1966), besides *hadd* ('border; punishment for a crime'),

6 Similar expressions are found in Arabic as well as in any language having borrowed Ar. *ḥadd*.

7 Haim 1992. The typology of corporal punishment may vary; cf. *hadd zadan* 'punire con la pena del bastone' in Coletti, Grünbaum Coletti 1978.

also mentions a form *hand* (p. 977 with initial *o*) ‘measure, dimension’. Similarly, Badaxši 1960 gives *hand* ‘measure [andāze], limit [hadd]’. Pashto *hand* reminds Southern Kurdish *hind* ‘measure, quantity [andāze, meqdār]’ (Hažār 1990, initial *o*),<sup>8</sup> Tonekāboni (Māzandarān) *handi* ‘measure, size, figure [andāze, qāmat, heykal]’, given as a ‘retrieved’ [bāzyāfte (mostadrek)] word in Adib Tusi 1963-1964. If these words do belong here,<sup>9</sup> the intrusive *n* could be due to the interference with another Ir. lexical set connected to the notion of MEASURE (i.e., Prs. *andāze* and its Iranian cognates<sup>10</sup>).

Somewhere semantic specializations for *had(d)* have emerged and/or morphosemantically motivated words (i.e., compounds and derivatives) or specific idioms with a local diffusion have been created. Prs. *sarhadd* ‘frontier, borderline, boundary region between countries’ and *bihad(d)* ‘boundless, unlimited, excessive’ have been borrowed throughout Iranian. Limited to local diffusion are Šuštari *hedda* ‘stone walls in the course of a river’ (Fāzeli 2004), Zarqāni (Fārs) *hadgāh* ‘enclosed part of a graveyard where the members of a family are buried’ (Malekzāde 2001), Kurdish *hed* ‘race (de cheveux)’ (Jaba-Justi 1879), and the lexical set which includes Māzandarāni (Tabari) *hadārī* ‘border, boundary’ (Humand 2003), (Āmoli) *hedār* ‘straightforward [mostaqim]’ (Partavi Āmoli 1979), Semnāni *hedār* ‘boundary between two fields belonging to different landowners’ (Sotude 1963), Sangesāri *hed@r* ‘vicinity; area [Prs. barābar, jehat]’ (Azami, Windfuhr 1972), Damāvandi *hedār* ‘in the extension; on a line; border, bordered; direction’ (Timuri Far 1983).

Worth noting is also Daštstāni *had zadan* ‘to reach the age of puberty’<sup>11</sup> (Borāzjāni 2003), which contrasts with Prs. *had(d) zadan* ‘to inflict a corporal punishment’, mentioned above.

In some Iranian dialects, borrowings from Ar. *ḥadd* still preserve the sense of ‘strength’, ‘power’, as illustrated by Tajik *hadd doštan* ‘to have the power or the possibility’ (FZT), Sorani Kurdish *hed* ‘power, authority; weight’ (Kurdoev, Jusupova 1983), Ĵirofti *had kerdn* ‘to press, to push; to strengthen [mohkem kardan]’ (Dehqāni 1998) and probably Zarqāni *hend* (also *hen*) ‘strength, power [niru, tavānāyi]’ (Malekzāde 2001), in this case with an intrusive nasal.

8 On Southern Kurdish *hind* see also below.

9 In the case of Pashto *hand* and Kurdish *hind*, the difference in orthography (initial *o* vs. *o*) could point to a more advanced degree in the integration process.

10 Cf. Pahl. *handāxtan* ‘to plan, allot, reckon, judge’ and cognates, whose etymology has been a matter of debate; see lastly Cheung 2007, p. 374 s.v. \**tač*<sup>2</sup>.

11 Cf. Prs. *hadd-e boluy* ‘the age of puberty, full-age’, mentioned above.

### 3 Some Cases of Grammaticalization

In my essay on Balochi locative expressions of some years ago (Filippone 1996), I illustrated the usage in Western and (less frequently) Southern Balochi of the function word (*h*)*əddā* in connection with the category of spatial relationships which I unified under the label ‘Control of the surrounding space’ (Filippone 1996, pp. 255 ff.). As I stated there (p. 259), the locative *həddā* «refers more frequently to the area of conceptual control, i.e. the area to which one belongs. Nevertheless, it is also used to indicate the concrete physical space in which the Figure is placed». <sup>12</sup> I also provided the following examples (pp. 259-260):

- (1) *fuṭbal drəxte ədda int* (Noške [Pakistan])  
‘the ball is near the tree’
- (2) *kəša əmməy ədda ɪstɪmal nəbit* (Xāš [Pakistan])  
‘*kəša* is not used by us’
- (3) *məy ədda məz int* (Irānšahr [Iran])  
‘next to us there is the table’

Bal. (*h*)*əddā* clearly comes out from the content word *hədd*,<sup>13</sup> which is ‘border, limit’ all over in Balochi, but also means ‘place’ in Western and Southern Balochi<sup>14</sup>; Brāhui *had* (‘boundary, bonds; place’, Bray 1934 s.v.) behaves in a similar way. As remarked in Barker, Mengal 1969, 1, pp. 143-144, however, (*h*)*ədd* means ‘place’ only when occurring in locative constructions;<sup>15</sup> to illustrate the point, the authors compare «/e məni [h]ədd ynt/ This is my boundary. [I.e. the border line between my field and someone else’s.]» with «/ a məni [h]əddā nyndit./ He will sit by me» (p. 144).

There is a word in Balochi whose meaning partially overlaps with that of (*h*)*ədd* and which displays a certain phonetic similarity with the latter: this is *hənd* ‘place’. Explaining the differences in meaning between four Bal. words which can be translated in English as ‘place’, Barker and Mengal state, with regard to *hədd* and *hənd*, that «/[h]ədd/ is the more specific, denoting a place delimited by rather specific borders. /[h]ənd/ refers to a

<sup>12</sup> See also Barker, Mengal 1969: [*h*]əddā ‘at the place of, near, by, at, *chez*’; Collett 1986: *haddā* ‘at the home of, at the place of, by, near’; Elfenbein 1990: *haddā* ‘nearby, at the house of’.

<sup>13</sup> On the morphosyntactic features of the Balochi spatial lexicon see Filippone 1996, pp. 67-83.

<sup>14</sup> Cf. Filippone 1996, p. 332; Sayad Hashmi 2000, s.v.

<sup>15</sup> Apparently, this is not true for Brāhui *had*; cf. *nī arā haddān-a barēsa?* ‘what place do you come from?’; *nan hamē haddaṭī kḥanān-ta* ‘we saw him at that place’ in Bray 1934, s.v. *had*.

larger, less well-defined area: a region, district, etc.» (p. 266 [32]). This assertion probably holds for the Western Balochi dialect described by the authors, where (*h*)*ənd* seems to be rarely used. In fact, it is not clear to me whether this word is to be considered as peculiar to some dialectal areas only. It is surely a basic word in Eastern Balochi, of a very high frequency and well documented in dictionaries and texts.<sup>16</sup> It is also used in (at least) some Southern varieties, as confirmed to me by a Bal. speaker native of Turbat.<sup>17</sup> Seemingly, in these varieties the physical dimension of the referent does not condition the usage of *hənd*, which may refer to the place where one is sitting, where one lives (one's dwelling place – home or village), where one is buried in the graveyard, to the land which one possesses, etc., with no restrictions at all (cf. Sayad Hashmi 2000, s.v.).

Nowadays, Bal. *hədd* and *hənd* are doubtless perceived as two different words; only the former seems to be able to lose referentiality and be used with relational implications, becoming one of the countless instances in all the languages of the world of a spatial grammatical marker generated by the 'place' > 'locative' process (cf. Heine, Kuteva 2002, p. 240). Strangely enough, the situation would seem to be inverted in Sayad Hashmi 2000, where *hənd* (and not *hədd*) has been accredited with the sense 'near [*gwər*, *kurr*, *nəzik*]'; this apparent oddity, in fact, attests that lexical contamination/blending is in this case a predictable phenomenon. Different etymologies (going back to different linguistic families) have been attributed to these two Bal. words. Scholars generally consider *hənd* as a Sindhi loanword<sup>18</sup> and refer to Si. *handhu* 'place, abode, bed', to which Kalasha *han*, *hand* «(1) temple of the goddess Jestak; (2) (Birir dialect) house» (Trail, Cooper 1999) may be associated. However, the isolation of the Sindhi and Kalasha words may be viewed as suspect; the reconstruction of an Indo-Aryan form \**handha-* by Turner (CDIAL 1966, p. 808 [no. 13970]) appears to be a rather *ad hoc* solution.

With regard to *hədd*, I wrote (Filippone 1996, p. 332) that the 'limit' → 'place' semantic extension «seems to occur solely in Balochi and Brāhui, in comparison with several Indian and Iranian languages with direct or indirect borrowing from Ar. *ḥadd* 'border'». This statement is

16 Cf. *hand* 'abode; home; house; place; seat' in Mayer 1910 s.vv. In Eastern Balochi, *hənd* also works as an element halfway between a morphological device and an autonomous lexical item to create derivate/compound words, similarly to Prs. *xāne* and *jā* (cf. *āshand* 'fireplace', *adālat hand* 'Court of Justice', *qaiz-hand* 'jail' and many others in Mayer 1910).

17 See also Sayad Hashmi 2000, s.v. This word also appears several times in the love ballad published in Elfenbein 1983, pp. 82-96 (from a MS probably written in a Coastal dialect, cf. pp. 4-5), but is missing from the final *Glossary*. I thank the anonymous reviewer who confirmed the usage of this word with the sense of 'region, district' in Southern Balochi.

18 Cf. Geiger 1890-1891, p. 450. It is uncertain whether Brāhui *hand* 'place, locality' has been borrowed from Balochi or directly from Sindhi; cf. Rossi 1979, p. 308 [I 111].

definitely wrong. I was unaware at that time that the mentioned semantic extension is in fact not so rare, and that, in some Iranian varieties spoken in South-East Iran, cognates of Bal. *hədd* also work with relational (spatial) implications.

Compare the following examples in Banāruye, Bixei and Qalāti (Lārestān), with *had*[-*e*] paralleling Prs. *kenār*[-*e*] and evoking the topological notion of PROXIMITY:<sup>19</sup>

Persian	Banāruye	Bixei	Qalāti (Evaz)
(4a) <i>čerâγ</i>	(4b) <i>čerâγ had-e</i>	(4c) <i>čerâx</i>	(4d) <i>čerâγ had-e</i>
<i>kenār-e divār</i>	<i>dovâr-e</i>	<i>haδ-e divâr-en</i>	<i>dovâr-e</i>
<i>ast</i>			

‘the lamp is near the wall’ (Salāmi 2009, p. 322; 2007, p. 312)

Persian	Banāruye
(5a) <i>baččehā kenār-e howz</i>	(5b) <i>bače-yâ had-e hōz avâz bod-</i>
<i>nešaste budand</i>	<i>et</i>

‘the children were sitting by the pond’ (Salāmi 2009, p. 368)

Rudāni *had* ‘near to [nazdik, kenār]’ (Mota‘medi 2001, p. 352), Fini *had* ‘near to [nazd, piš]’ (Naĵibi Fini 2002, p. 144); Minābi *had*[-*e*] ‘vicino, a fianco’ (Barbera 2004, p. 172)<sup>20</sup> are similarly deployed as function words, and show the same locative specialization.

In a handout distributed by Hamid Mahamedi on the occasion of one of the Meetings of the Middle East Studies Association,<sup>21</sup> the author presented the following Koroshi sentence, with the corresponding English translation:

- (6) *hade emâmbârâ boda*  
 ‘he has been with the Imams’.

19 According to Nabi Salāmi, who kindly answered to a question of mine, «*had* purely means ‘pahlu - by the side of’, ‘kenār - side’ in Banarouye’i, Bikhe’i and Qalati [...] *had* is merely an adverb of place in the Persian dialects and has no nominal usage» (e-mail dated 10 September 2011).

20 Cf. Min. *had-e me biey, aks begiri!* ‘venite a fianco a me per fare la foto’ (Barbera 2004, p. 172).

21 *Koroshi. The Iranian Dialect of Qashqâ’i’s Camel-Keeper*, MESA 1986.

For this and some other Koroshi sentences I am indebted to Gernot Windfuhr, from whom I received some years ago<sup>22</sup> a selection of examples drawn from the mentioned Mahamedi's handout. Answering to a question of mine, Gernot Windfuhr also suggested a connection of Koroshi *hade* 'with' with Lārestāni dialects *xode*, Fārs dialects/Shirāzi *xo* etc. 'id.' (on this matter see also below). However, the only other example with a 'with'-phrase (in this case, instrumental) among the Koroshi sentences kindly sent to me contains the preposition *gu*, which is the usual Bal. preposition *go/gō* 'with':

- (7) *nagana gu čiya mapačagət*  
 'with what do you cook the bread?'

That to express both comitative and instrumental relation *gu/go* is the preposition commonly used in Koroshi, is confirmed by the relevant examples in Salāmi 2006, where it occurs as the counterpart of Prs. *bā*:<sup>23</sup>

Persian	Koroshi
(8a) <i>diruz bā xānevāde</i>	(8b) <i>zi go čokk-obâr raft-en</i>
<i>be ĵangal raftim</i>	<i>ba ĵanġalâ</i> <sup>24</sup>

'yesterday we went to the wood with the family'

- (9a) *barādaram Ahmad rā bā xod* (9b) *a:mad berâdâ gu vad-om*  
*mibordam* *mabarayad-ân*<sup>25</sup>

'I brought my brother Ahmad with myself'.

Since Koroshi is a Balochi dialect spoken by camel herders working for the Qashqais in several spot of Fārs and elsewhere (cf. Jahani, Nourzaei 2011, p. 63) it seems reasonable to assume that *hade* occurring in the Koroshi sentence cited above is to be analyzed as *had* ('limit, edge') plus the *ezāfe*, with the same locative function we have seen in other Balochi varieties and in some dialects of South Iran; the inversion of the syntactic sequence, usual in Koroshi, and the introduction of the *ezāfe* construction may be due to interference through contact. In fact, this is not an 'exceptional'

22 E-mail dated 30 October 2004.

23 In concomitance with Koroshi *go* 'with', one finds: Davāni, Dahlei *xođ-e* (Salāmi 2004, p. 279); Dusirāni *xođ-e* (Salāmi 2005, p. 281); Birovakāni *xođ-e* (Salāmi 2006, pp. 299 and 311); Aheli *xoy*, Qalāti *xođ-e* (Salāmi 2007, p. 325); Evazi *xođ-e*, Banāruye, Fedāyi *xođ-e*, Galedāri *xođ-e* (Salāmi 2009, p. 335), Bixei *a:re-y* (Salāmi 2009, pp. 335 and 347).

24 Salāmi 2006, p. 299 [31].

25 Salāmi 2006, p. 311 [56].

construction in Koroshi, as evidenced by the phrases *rū-ye ordā* 'at the camp', *sar-e šeyā* 'at the slope', etc. occurring in a Koroshi folktale published in Jahani, Nourzaei (2011, pp. 65 and 67). If this suggestion is correct, Koroshi (6) *hade emâmbârâ boda* may be intended as 'he has been with the Imams' only in the sense that 'he has been *chez/by* the Imams', or in a similar way.<sup>26</sup>

In his Dictionary of Zoroastrian Yazdi, Kešavarz (1993, p. 121) introduces the word *had* 'side, direction [taraf]' with relevant phraseology (*o hadæ* 'that side', *kom hadi* 'which side'). It is not clear whether he considers the subsequent entry, *hadi* 'to [be]' – for which the variants (dial. of Šarif Ābād) *xoy* and (dial. of Xoramšāh, Ahrestān and Bāy-e Golestān) *hāre* are also given in brackets<sup>27</sup> – as having to do with the already mentioned *had* 'side': i.e., an originally content word which would have acquired a new function through a grammaticalization process. This seems to be the opinion of David Lorimer as far as Zoroastrian Kermāni/Yazdi *had i* is concerned. In his *Notes on the Gabri Dialect of Modern Persian* (Lorimer 1916), intended as a critical comment on the Central Dialect material contained in the *Grundriss der iranischen Philologie*, he mentions *had-i* 'towards', equivalent to Prs. (*be*) *taraf-e*, among the «nouns which are followed by the *izāfa* and have a preposition expressed or understood before them» (p. 481); therefore, in that same paragraph, entitled *Indeclinabilia*, he keeps it separated from «*xadō* occasionally *xadī* = with, along with (association, instrument, means)», which is given in a list of 'Independent Prepositions' (p. 479). The problem, however, is far from being solved.

In Zor. Yazdi and Kermāni, 'with'-relations are expressed by means of a preposition which occurs in several variants, some of which dialectally marked. The same preposition is commonly used to express directionality in the case of verbs of saying (i.e., it introduces the person to which something is said). According to the different describers, we find the following variants:

Gabri *xad*, *xado*, *xadū*, *ado*, *adū*, *adu*, etc. (Ivanow 1936-1939, p. 96)<sup>28</sup>

Zor. Yzd. *ado*, *xadi*; Zor. Kerm. *xodi*; Zor. Yzd. / Kerm. *âr* (Sorušian 1956)

Zor. Yzd. (*h*)*ado*, *hadi*, *hade* [urban variants]; *xodo*, *xodi*, *xode*, *xadi*; *hāre* [rustic variants] (Mazdāpur 1995, s.v. *bā*)

26 Many thanks go to the anonymous reviewer of this paper who provided the following additional examples: (1) *arra hade ya cōbānēyā* 'he goes to a shepherd'; (2) *korraga akay hadī* 'the foal comes to him'.

27 Note that in the texts published at the end of the volume (*baxš-e sevvom*) only the form *hāre* is attested.

28 Note that in the texts published, *a*°-forms only occur in Yazdi, *x*°-forms prevalently in Kermāni.



Zor. Yzd. *xadō*, *xad/t*, *xadū*, *adō*, *adū* (Vahman, Asatrian 2002, p. 26 in a paragraph in which «interesting archaic units» are commented on)

Kerm. *xod* (Sotude 1957, etc.)

Cognates of Yzd. (*h*)*ado*, *hadi*, *xadi*, *har*<sup>29</sup> etc. are well attested in several Central dialects (without characterizing any specific sub-group in particular); cf., e.g., Xunsāri *χud*, *χo*, *χō<sup>u</sup>* (Eilers 1976, p. 59), Gazi *χōu*, *χō*, Esfahāni *χod* (Eilers 1979, 2, p. 697), Farizandi, Yarani *χāj*, Zefrei, Sedehi, etc. *hō*, *hū*, *how*, Kešei *how* (Christensen 1930, pp. 194, 238), Bizovoi *xodō*, Abyānei, Anāraki *xoy*, Ardestāni *xow*, Nāini *xo*, *xoy*, Qohrudi *xod*, Tāri, Varzenei *xo* (Lecoq 2002), Arāni/Bidgoli *xoj* (‘Alijānzāde 1993), Bardesiri *xod* (Barumand Sa‘id 1991). But we also find them in the ‘Persic’ area of South and South-East Iran [cf. Davāni *xoδ* (Salāmi 2002), Dašttestāni *xode* (Borāzjāni 2003), Lāri *xod(-e)* (Kamioka, Yamada 1979, nn. 413, 415, 498)]<sup>30</sup> and in Eastern Persian dialects [cf. Xorasāni *xedey* (Šālči 1991), Birjāndi *xod* (Rezāi 1994), Qāini *xod*, *xodeyi* (Zomorrodīān 1989), Sistāni *xe* (Mohammadi Xomak 2000) and probably also Hazaragi *xon*, *xō* (Dulling 1973)]<sup>31</sup>.

In the light of what has been said above, one hesitates to attribute to Yazdi a function word *hadi* ‘towards’ (from < *had* ‘direction’), distinct from *hadi*, *hado* etc. ‘with’. Introducing the example *hadi un veva* ‘tell him [be u begul]’ s.v. *hadi* ‘towards’, Kešāvarz (1993) might have been conditioned by its Persian equivalent in this particular context: as already mentioned, a

29 Consider here also Bixei *a:re* above in fn. 26.

30 For other instances in Lārestāni and Fārs dialects, see also above, fn. 26.

31 The etymology of this set of cognate function words is questionable. Many scholars refer to OIr. \**hadā/ā* (OP *hadā*, Av. *haḁa*, Man. Parthian *‘d*, Oss. *æd*, etc.); see Ivanow 1936-1939, p. 96, Rezāi 1994, p. 192, Monchi-Zadeh 1990 no. 576, Vahman, Asatrian 2002, p. 26. Personally, I am more inclined to support the tentative suggestion by Eilers (1976, p. 59), who thinks to a possible connection with the reflexive pronoun («Ist das *χ<sup>v</sup>ad-i?*»). To a special usage of *xod* also points Mohammadi Xomak 2000, p. 179. Evidence for the latter hypothesis may be the phonetical correspondence of the ‘with’-forms with the ‘self’-forms peculiar to each dialect, the frequent presence of *ezāfe* constructions and, even more, the usage in Sarawāni Balochi (Baranzehi 2003, p. 85: *wate gaḁḁagān* ‘with the seeds’) and probably in some other (unspecified) Iranian Bal. dialect (Ayyubi 2002, p. 104: *wət əhməda* ‘with Ahmad’) of a form *wət* heading ‘with’-phrases, hardly to be separated from Bal. *wət* ‘self’. It could be reasonable to consider this very peculiar usage of *wət* as an instance of a linguistic calque (‘self’ → ‘with’) due to the influence of the languages in contact, i.e. Larestāni and Sistāni dialects. Admittedly, this path cannot be included in a list of regular paths of grammaticalization with reflexive as a source (in Persian, e.g., *xod* is used as ‘self’-intensifier, reflexive anaphora and focus particle since Early New Persian onwards [cf. Lazard 1963, pp. 446-449], according to universal patterns of grammaticalization), and I am not able to mention at the moment any other language where a ‘with’-form has derived from a ‘self’-form.



'with'-phrase with *hadi*, *hado* etc. is the most common strategy with verbs of saying in Yazdi and other languages.<sup>32</sup> Whatever the situation in Yazdi, the usage in some Iranian varieties of *had(d)* as a function word conveying the notion DIRECTIONALITY is considered by some Iranian scholars as a well-known phenomenon and we may take it for granted.<sup>33</sup>

I would analyse in this connection also Zazaki *het* 'Seite' (Paul 1998), which works as a secondary adposition (preposition *hetē* 'zu... hin' [p. 105], postposition *het(i)* 'zu... (hin) (meist nach belebten Nomina)' [p. 109]). The usage of this item (*het* 'Seite, Richtung, Region') as a function word («Ezafekonstruktion») has been suggested by Keskin (2008, p. 50 and fn. 79) as a major linguistic trait relevant to the dialectological classification of Zazaki. According to him, it characterizes the Central and Southern dialects, though «ist aber auch in Bingöl-Adaklı (Karêr) gängig, z.B. šona hetē amika xo „sie geht zu ihrer Tante“».

As a function word, Zazaki *het* conveys locative implications which may include or not the notion DIRECTIONALITY;<sup>34</sup> see the following sentences which display a strong similarity in usage of Zazaki *het* with Bal. [*h*]ədd etc., seen above:<sup>35</sup>

(10) *bē mā het* (dial. of. Eğil)  
'komm zu uns' (Paul 1998, p. 234)

(11) *o yo to hetî*  
'he is with you' (Paul 2009, p. 568).

32 Note, however, that even in Persian the second argument of a verb of saying may be expressed with a 'with'-phrase (i.e., it may be introduced by the preposition *bā*).

33 In reply to a question of mine, Hasan Rezāi Bāghbidi wrote to me what follows: «I can add that the Arabic word '*hadd*' plus the Persian *ezafe* particle *-e* functions as a preposition in some Iranian dialects, thus *had(d)-e* means 'in the direction of, to the direction of, towards, etc.'» (e-mail dated 8 May 2011).

34 In fact, this is only true for the secondary postposition *het(i)*. As far as I know, a phrase headed by the secondary preposition *hetē* always points to the goal of a motion. An analogous behaviour could be that of (Marv) Balochi *demî* (prep.) 'towards' vs. *dema* (postp.) 'in front of; towards'; cf. Filippone 1996, pp. 81-82, 163-164. In the Siwerek Zaza Glossary (Hadank 1932, p. 158), «*hāt* [Postpos.] zu, nach» is distinguished from «*hāti* [Postpos.] mit, bei», the latter referred to Oss. *æd* 'with'. However, this differentiation does not find a confirmation in the description of the Siwerek dialect which precedes the Glossary; cf. Hadank 1932, p. 81. Highlighting the strong influence exerted by Armenian on Zazaki, Garnik Asatrian (e-mail dated 6 September 2012) points out the fact that Zaz. *het(i)* «at least when it expresses the notion of instrumentality, may probably be from Arm. *het* 'with' (< IE \*ped-?)».

35 Interestingly, Todd (1985, p. 120) finds it difficult to give an English equivalent for the 'postposition' *hət* («Fr. 'chez', Ger. 'bei'»).

In the Kurdish–Persian dictionary compiled by Hažār (1990), which mainly collects Southern Kurdish material, one finds the form *hat* ‘near [piš, nazd]’. Āmorei *hat* ‘side, direction [samt, jehat, su]’ (‘Ādelxāni 2000) likely belongs here. To explain these words as naturalized forms of a (direct or indirect) borrowing from Ar. *ḥadd*, one has to account for the loss of sonority ( $d > t$ ). As for Zazaki, I can only mention *kāyid/t* ‘paper’, *kilīt* ‘key’ and a few other words. Desonorization of word-final *d*, however, is a fairly frequent phenomenon in Southern Kurdish dialects and has already been described by Fattah (2000, pp. 141-142).

Probably, here also belongs *han* ‘side, direction’ attested in the Lori dialect of Bālā Garive (Amanolahi, Thackston 1986): one has to assume  $d(d) > nd$  (dissimilated with unetymological *n*)  $> n$ , an expected development in this dialect, where /d/ is regularly deleted when occurring in the sequence /nd/ (p. 198). At this point, one could also fall into the temptation of expanding the dossier with Kurdish (Kurmanji) *hind* ‘side, direction’; *hinda* ‘2) prep. around, beside, by, near; to’; *henda* ‘1) side, direction; 2) prep. around, beside, by, near; to’ (Kurdoev 1960); (Southern Kurdish) *hind* ‘measure [andāze, meqdār]; side, direction [taraf, su]; near, beside [nazd, piš]’ (Hažār 1990), etc. However, here the situation might be different. To explain Kurd. *hind(a)*, scholars generally refer to Ar. ‘*inda* (‘at, near, by, etc.’<sup>36</sup>),<sup>37</sup> and in fact the similarity of meaning and functions makes it difficult to dismiss this connection definitively. One should note, however, that, by rule, Arabic words starting with the pharyngeal fricative/approximant, when borrowed into Kurdish, do not change their initial consonant into a voiceless glottal or pharyngeal fricative.<sup>38</sup> Though, as noted by MacKenzie (1961, p. 23), in Kurdish loanwords from Arabic «there is a considerable confusion between *h* and ‘», this confusion mainly affects the inner or final part of the word. Exceptions may be found: Cabolov (1976, p. 66), e.g. quotes Kurd. *hamd* ‘will’ (< Ar. ‘*amd* ‘intention’) and *habas* ‘in vain’ (< Ar. ‘*abat<sup>an</sup>*’) as instances of Ar. ‘ $>$  Kurd. *h* («v načale i v seredine slova»); these two words, however, are variant forms of ‘*amd* and ‘*abas* (see also Cabolov 2001, s.vv.). In conclusion, for

36 Cf. Jaba-Justi 1879, p. 452 (s.v. *hinda* ‘à, vers’), Chyet 2003, p. 258 (s.v. *hinda* ‘prep. near, by, at the house of, over s.o.’s house [Fr. *chez*]’), Cabolov 2001, p. 420 (s.v. *handā, hind, hindā*). This latter in particular explains the nominal forms *hand, hind* ‘side, direction’ as secondary constructions from *handā*.

37 Cf. Lane 1863-1893, s.v. ‘*ind*: «app. as meaning The vicinage or the quarter, tract, region, or place of a person or thing [...] used in the manner of a prep., though properly a prefixed noun [...] it signifies at, near, nigh, near by, or close by, or place, or thing; with, present with, or in the presence of a person, or persons, or a thing or things; at the abode of a person; at the place of, or in the region of, a thing [...]».

38 Cf., e.g., from Chyet 2003: ‘*adet* ‘custom’ (< Ar. ‘*ādat*’), ‘*evd* ‘slave’ (< Ar. ‘*abd*’), ‘*ehd* ‘promise’ (< Ar. ‘*ahd*’), ‘*elamet* ‘report’ (< Ar. ‘*alāmat*’), ‘*emal* ‘work’ (< Ar. ‘*amal*’), ‘*ilm, ulm* ‘science’ (< Ar. ‘*ilm*’), ‘*eşq* ‘love’ (< Ar. ‘*işq*’), etc.

Kurd. *hind(a)*, one cannot exclude some kind of contamination between etymologically unrelated forms.<sup>39</sup>

As for Prs. *had(d)*, the conceptual association 'limit' → 'side/direction' favoured the acquisition of new senses, though in this case it is the plural form *hodud* which has mainly been affected, as attested in the dictionary entries listed above.<sup>40</sup> Persian *hodud* may lose its referential value and be used with locative relational implications, in particular in the phrasal expression *dar hodud[-e]* 'about, in the neighbourhood of, in the whereabouts of'.

In his Preface to the English edition of Barthold's Russian translation of the *Hodud al-Ālam*, the famous geographical work dating back to the fourth/tenth century, Vladimir Minorsky motivated the English title *The Regions of the World* with the following words: «The word *ḥudūd* (properly 'boundaries') in our case evidently refers to the 'regions with definite boundaries' into which the world is divided in the H.-Ā., the author indicating with special care the frontiers of each one of these areas», adding: «As I use the word 'region' mostly for *nāḥiyat* it would have been better, perhaps, to translate *Ḥudūd al-Ālam* as "The limited areas of the World"» (Minorski 1937, p. vii fn. 2). He also refers to Barthold's statement on the matter, which one can read in *V.V. Barthold's Preface* (p. 30): «The word *ḥudūd* in Arabic geographical literature means not so much 'frontiers', in the sense of frontier-line, as 'limits' in the sense of *the total extent of a territory* [my italic]» (see also Minorsky 1955, p. 256). The cognitive association 'limit → (delimited) place' can be traced back to the contiguity relationship between these two concepts, and does not differ from that which produced Lat. *fīnēs* 'territory, land, country enclosed within boundaries' from (sing.) *fīnis* 'boundary, limit, border'.

A similar usage of this word is found in some dialects of Iran. In one of the tales in the Lori dialect of Bālā Garive published in Amanolahi, Thackston 1986 one can read (p. 136):

(12) *ma baram-at tâ hudûd ʔ giya.*

Exactly the same sequence occurs in the same page, nine lines below; unfairly, the two *hudûd* receive different treatments by the translators (p. 37):

(12a) I will take you to the border of the [first] brother

(12b) I will take you to my brother's territory.

<sup>39</sup> G. Asatrian (see fn. 39 above) rejects an Arabic origin for Kurd. *hind(a/ā)*, [«- from \**ima-da-?*»] and suggests considering *ha/ind-* forms as «enlarged variants [...] with *han/m*» of *d*-particles, as *da/i* in Kurdish, *de/a* in Central dialects, etc. (according to him, auxiliary words with no historical background), «contaminated further [...] with foreign forms».

<sup>40</sup> See however also *hadd* 'side, direction [jāneb, suy, taraf]' in Ānandarāĵ and other references in Dehxodā s.v.

That no idea of 'border' is implied in both passages is beyond question. In some Eastern varieties of Persian, however, borrowings from Ar. *ḥadd* may convey the sense of 'place', 'region', etc. even in the singular form. In dialectal Tajik, e.g., besides *had* 'border' (*ad* in Badaxšāni, cf. *adi zamin* 'border of a field'), we find Karategin *həd* '(upper or lower) part of a village', *hədi bolo* 'upper part of a village', *hədi poyon* 'lower part of a village' (Rozenfel'd 1982). To it one may add Herati *adə/ade/ede* 'side; stretch of road' (Ioannesjan 1999, p. 101) and Sistāni *add* 'whereabouts, location [hadd-o-hodud]' (Mohammadi Xomak 2000). Possibly, to an Eastern dialectal feature also points the presence of *hadd* in the following sentence from the *Tarjome-ye Tafsir-e Tabari* III 125 b (quoted according to Lazard 1963, pp. 447-448):

- (13) *az ḥadd i man bērūn šau ki xudāy i tu har kuḵā ki šavē tu rā xʷad  
nigāh darād*  
'sors de mon territoire, car ton Dieu te protège où que tu ailles'.

The semantic extensions of the Iranian borrowings from Ar. *ḥadd* we have seen above are not completely extraneous to the original Arabic word (cf. above 'side, region, quarter or tract' in Lane 1863-1893). Even the grammaticalization processes traced in some Iranian varieties are already attested in Arabic, at least in some of its local varieties. Apart from the fact that in different dialectal areas Ar. *ḥadd*, preceded by a preposition (*li*, 'ilā), is used to express a temporal or spatial end point, as in (Jerusalem) *la-ḥadd il-ʿēn* (Procházka 1993, p. 226) 'up to the spring', (Gulf region) *miša ʿila ḥadd l-kubri* 'he walked as far as the bridge' (Qafisheh 1997, s.v.), particularly worth noting is that in the Arabic varieties of Lebanon, Palestine and the region of Maṣyāf, it has become «die übliche Präposition für die Angabe eines lokalen Nebeinenderer» (Procházka 1993, p. 225). Here *ḥadd* presents striking similarities in function with Bal. *hədda*, Minābi *had[-e]*, etc.; cf. Ar. *ḥadd əl-ḥayṭ* 'near the wall', (Jerusalem) *ḥadd el-bāb* 'near the door', (Lebanon) *t'a q'od ḥadd manne* 'come and seat by me', etc. (Procházka 1993, pp. 225-226). However, I am not in a position to say whether we are facing here with independent developments, or with a phenomenon first originated in one of the Arabic dialects.

#### 4 Final Remarks

The analysis of the data presented above may lead to various considerations, which however is not my intention to expand. The first is the more general question about the possible multiple transfer channels in a borrowing process: if one believes that Bal. *hədda*, Minābi *had[-e]*, etc. are somehow connected to (Palestinian, Lebanese etc.) Ar. *ḥadd* 'near', one

should emphasize the fact that both Literary Arabic and Literary Persian (mostly considered as the vehicle for Ar. borrowings into other Iranian languages) are not involved, and the interested areas are not in a contact situation. The second consideration concerns the possible effects of borrowing in the target language lexicon, and the impacts a new entry may produce on native words. From this perspective, I wonder if inner factors may also have contributed to determine the status of *had(d)* in Iranian, as depicted in this paper.

The Old Persian word *hadiš-*, occurring several times in the Achaemenid inscriptions, always in passages where the King ascribes to himself (or even to his own father, in the case of Xerxes) the construction of a *hadiš*, is traditionally translated ‘palace’, but probably is to be intended as ‘seat, dwelling place, abode’. The standard reference is to Avestan *hadiš-*, which is the name of the Household God, and Sanskrit *sádas-* ‘seat, abode, home’.<sup>41</sup> Apparently, Old Persian *hadiš-* disappeared, without leaving traces in Middle Iranian (at least, judging from the available documentation), but if we look for cognates in modern times, Zor. Yazdi *hedeš* ‘summer quarter [mahalle tābestāni, yilāq]’ (Sorušīān 1956) seems to be a good candidate. According to Afšār 1990, *Hedeš* is the ancient name of one of the famous summer quarters of Yazd, nowadays commonly called *Deh-e bālā*; this ancient toponym is still used in contracts and by old people in conversation.<sup>42</sup>

My tentative suggestion is to take into consideration an alternative hypothesis to that of the mere extinction of the lexical set of Old Prs. *hadiš-* and its possible cognates in other Iranian languages, and to assume a sort of sound-induced blending of foreign and native words, whose semantic range happened to overlap partially, with the latter got entangled up in the former, but still responsible for some particular semantic developments. This is however a pure conjecture, which, by the very nature of the surmised phenomenon and lack of evidence, is doomed to remain such.

41 Cf. lastly Schmitt 2014 s.v. On more details and bibliographical references on *hadiš-*, I refer to the relevant voice in Glossary in Basello, Giovinazzo, Filipponi, Rossi (forthcoming).

42 Garnik Asatrian (see fn. 39 above) has brought to my attention other possible New Iranian outcomes of Old Iranian *\*had-*, which he quotes under the entry غوشاد [yōšād] ‘a ni ght-fold for cattle; a halting place for caravans’ in the draft of his etymological Persian dictionary (in preparation). In particular, apart from *yōšād* itself (< *\*gau-šāda-* ‘cowshed, cow-place’, the second element from Old Iranian *\*had-*), he also mentions Abyānei *hās* and Bizovoi *xas* ‘sheep-fold; stable’ (< *\*hasta-*, cf. Avestan *pasuš-hasta-*, Pahlavi *pahast* ‘sheep-fold’).

## Acknowledgements

Since I have decided to write the present paper, and even before, when I have started to collect material on the topic, several people have been approached by me with questions on single points and kindly contributed in different ways (giving information, suggestions, bibliographical references, reading the draft, etc.). They are (in alphabetical order): Garnik Asatrian, Riccardo Contini, Matteo De Chiara, Mansoor Farahpoor, Angelo Piemontese, Hassan Rezāi Bāghbidi, Adriano V. Rossi, Badal Khan Sabir, Nabi Salāmi, Gernot Windfuhr. To all of them, a friendly, heartfelt 'thanks'.

## Bibliography

- Ādelxāni, Hasan (2000). *Farhange Āmorei (vāženāme, farhang-e emsāl va kenāyāt va..)*. *Jeld-e avval*. Arāk: Payām-e digar, 1379.
- Adib Tusi, Mohammad Amin (1963-1964). «Farhang-e loyāt-e bāzyāfte (mostadarak)». *Našrie-ye dāneškade-ye adabiāt-e Tabriz*, 15 (3-4) (1342/1963); 16 (1-3) (1343/1964).
- Afšār, Iraǰ (1990). *Vāženāme-ye yazdi*. Tanzim va āvānevisi az Mohammad Rezā Mohammadi. Tehrān: s.n., 1369.
- Afšār Sistāni, Iraǰ (1986). *Vāženāme-ye sistāni*. Tehrān: Bonyād-e Neyšābur, 1365.
- ‘Aliǰānzāde, Hossein (1993). *Zabān-e Kavir. Ketāb-e avval: Tahqiq dar zabān-e Ārān va Bidgol*. N.p.: Mo‘allef, 1372.
- Amanolahi, Sekandar; Thackston, Wheeler M. (1986). *Tales from Luristan (Matalyā Lurissu)*. Harvard: Harvard University Press.
- Andreev, Mixail S.; Peščereva, Elena M. (1957). *Jaǰnobskie teksty*. Moskva; Leningrad: Izd. Akademii Nauk SSSR.
- Aslanov, Martiros G. (1966). *Afgansko-russkij slovar’ (puštu): 50000 slov. Pod red. N.A. Dvorjankova*. Moskva: Izdat. Sovetskaja Ėnciklopedija.
- Ayyubi, Ayyub (2002). *Dastur-e zabān-e fārsi be baluči*. Irānšahr: Asātir, 1381.
- Azami, Cheragh Ali; Windfuhr, Gernot L. (1972). *A Dictionary of Sangesari with a Grammatical Outline*. Tehran; Šerkat-e Sahāmi-e Ketabhā-ye Jibi.
- Badaxši, Š. [= Šāh ‘Abdullāh] (1960). *Də Afyānistān də cīno žəbo o lahjo qāmus - Dictionary of Some Languages and Dialects of Afghanistan*. Kābul: Pašto Țolana, 1339.
- Baranzehi, Adam N. (2003). «The Sarawani dialect of Balochi and Persian influence on it». In: Jahani, Carina; Korn, Agnes (eds.), *The Baloch and their Neighbours: Ethnic and Linguistic Contact in Balochistan in Historical and Modern Times*. Wiesbaden: Reichert, pp. 75-111.
- Barbera, Gerardo (2004). *Lingua e cultura a Mināb (Iran sud-orientale). Profilo grammaticale, testi e vocabolario* [doctoral dissertation]. Napoli: Università degli Studi di Napoli «L’Orientale».

- Barker, Muhammad Abd-al Rahman; Mengal, Aqil Khan (1969). *A Course in Baluchi*. 2 vols. Montreal: Institute of Islamic Studies McGill University.
- Barumand Sa'īd, Javād (1991). *Vāženāme-ye guyeš-e Bardesir*. Tehrān: Markaz-e Kermānšenāsi, 1370.
- Basello, Gian Pietro; Filippone, Ela; Giovinazzo, Grazia; Rossi, Adriano V. (forthcoming). «XPc». In: Basello, Gian Pietro; Filippone, Ela; Giovinazzo, Grazia; Rossi, Adriano V., *DARIOSH Studies I: The Achaemenid Royal Inscriptions in an Intertextual Perspective*. Napoli: Università degli Studi di Napoli «L'Orientale», pp. 1-98.
- Bau, Pierre (2003). *Dictionnaire persan-français / français-persan*. Paris: La Maison du dictionnaire.
- Benzing-Taraf (1983). Benzing, Johannes. *Chwaresmischer Wortindex, mit einer Einleitung von H. Humbach herausgegeben von Zahra Taraf*. Wiesbaden: Harrassowitz.
- Borāzjāni, Tayyeb (2003). *Seyr-i dar guyeš-e Dašttestān*. Širāz: Rāhgošā, 1382.
- Brauer, Ralph W. (1995). *Boundaries and Frontiers in Medieval Muslim Geography*. Philadelphia: American Philosophical Society.
- Bray, Denis (1934). *The Brāhūī language, part 2, The Brāhūī problem; part 3, Etymological vocabulary*. Delhi: Manager of Publications. Repr. 1978.
- Bron, François; Cohen, David; Lonnet, Antoine (2010). *Dictionnaire des racines sémitiques ou attestées dans les langues sémitique*. Vol. 2, Fasc. 9 (H). Leuven: Peeters.
- Buck, Carl Darling (1949). *A Dictionary of Selected Synonyms in the Principal Indo-European Languages: A Contribution to the History of the Ideas*. Chicago: University of Chicago Press. Repr. 1988.
- Cabолоv, Ruslan L. (1986). *Očerk istoričeskoj fonetiki kurdskogo jazyka*. Moskva: Nauka.
- Cabолоv, Ruslan L. (2001). *Ètimologičeskij slovar' kurdskogo jazyka*. Tom 1. Moskva: Izd. firma Vostočnaja literatura RAN.
- CDIAL (1996). Turner, Ralph L. *A Comparative Dictionary of the Indo-Aryan Languages*. London: Oxford University Press.
- Cheung, Johnny (2007). *Etymological Dictionary of the Iranian Verb*. Leiden; Boston: Brill.
- Christensen, Arthur (1930). *Contributions à la dialectologie iranienne: Dialecte guilākī de Recht, dialectes de Fārīzānd, de Yaran et de Natanz: Avec un supplément contenant quelques textes dans le persan vulgaire de Téhéran*. København.
- Chyet, Michael L. (2003). *Kurdish-english Dictionary / Ferhenga Kurmançî-Inglîzî*. Yale: Yale University Press.



- Coletti, Alessandro; Grünbaum Coletti, Hanne (1978). *Dizionario persiano/italiano classico-moderno-familiare*. Roma: Centro Culturale Italo-Iraniano.
- Collett, N.A. (1986). *A Grammar, Phrase Book and Vocabulary of Baluchi (as Spoken in the Sultanate of Oman)*. 2nd ed. Abingdon: Burgess & Son.
- Dehqāni, Eslām N. (1998). *Barresi-ye guyeš-e Ĵiroft va Kahnuĵ*. Kermān: Markaz-e Kermānšenāsi, 1377.
- Dehxodā, A.A. (1946-1981). *Loyatnāme*. Tehrān 1325-1360.
- Desmaisons, Jean Jacques Pierre (1908). *Dictionnaire persan-français par le Baron Jean Jacques Pierre Desmaisons, publié par ses neveux*, vol. 1. Roma.
- Dulling, Gurth Kenton (1973). *The Hazaragi Dialect of Afghan Persian: a Preliminary Study*. London: Central Asian Research Centre.
- Eilers, Wilhelm (1976). *Die Mundart von Chunsar. [...] Unter Mitarbeit von Ulrich Schapka*. Wiesbaden: Franz Steiner Verlag.
- Eilers, Wilhelm (1979). *Die Mundart von Gāz. [...] Unter Mitarbeit von Ulrich Schapka*. 2 Bd. Wiesbaden: Franz Steiner Verlag.
- Elfenbein, Josef (1983). «A Baluchi Miscellanea of Erotica and Poetry: Codex Oriental Additional 24048 of the British Library». *Annali dell'Istituto Universitario Orientale di Napoli*, 43 (2), Suppl. 35.
- Elfenbein, Josef (1990). *An Anthology of Classical and Modern Balochi Literature*, vol. 2, *Glossary*. Wiesbaden: Harrassowitz.
- Fattah, Ismail K. (2000). *Les dialectes kurdes méridionaux: Étude linguistique et dialectologique*. Lovanii: Peeters. Acta Iranica 37.
- Fāzeli, Mohammad Taĳi T. (2004). *Farhang-e guyeš-e šuštari: Rišešenāsi va moqāyese bā fārsi va guyešhā-ye irāni: Zarb-ol-masalhā, nemunehā, vāženāme*. Tehrān: Pāzine, 1383.
- Filippone, Ela (1996). *Spatial Models and Locative Expressions in Baluchi*. Napoli: Istituto Universitario Orientale.
- FZT (1969). Šukurov, Muhammadjon Š.; Kapranov, Vladimir A.; Hošim, Rahim; Ma'sumī Nosirjon. *Farhang-i zabon-i toĳiki*. 2 vols. Moskva: Našrijoti «Sovetskaja Ėnciklopedija».
- Geiger, Wilhelm (1890-1891). «Lautlehre des Balūčī». *Abhandlungen der I. Classe der Bayrischen Akademie der Wissenschaften*, 19 (2), pp. 397-464.
- Goichon, Amelie-Marie (1971). «Ĥadd». In: *The Encyclopaedia of Islam*. New edition, vol. 3 (H-Iram). Leiden; London: Brill.
- Grjunberg, Aleksandr L.; Steblin-Kamenskij, Ivan M. (1976). *Jazyki vostočnogo Gindukuša: Vaxanskij jazyk: Teksty, slovar', grammatičeskij očerk*. Moskva: Nauka.
- Hadank, Karl (1932). *Mundarten der Zāzā, hauptsächlich aus Siwerek and Kor*. Berlin: Verlag der Preussischen Akademie der Wissenschaften: in Kommission bei W. de Gruyter. Kurdisch-persische Forschungen Abt. 3, Nordwestiranisch 4.



- Haim, S. (1992). *Farhang-e bozorg-e fārsi-englisi*. Tehrān: Farhang-e mo'āser, 1371.
- Hažār (1990). *Farhang-e kordi-fārsi*. Tehrān: Soruš, 1369.
- Heine, Bernd; Kuteva, Tania (2002). *World Lexicon of Grammaticalization*. Cambridge: Cambridge University Press.
- Humand, Nasrollāh (2003). *Pažuheš-i dar zabān-e tabari (māzandarāni)*. Āmol: Entešārāt-e tāleb-e āmoli, 1382.
- Ioannesjan, Jurij A. (1999). *Geratskij dialekt jazyka dari sovremennogo Afganistana*. Moskva: Vostočnaja literatura RAN.
- Ivanow, Wladimir (1936-1939). «The Gabri Dialect Spoken by the Zoroastrian of Persia». Parts 1-2 [pp. 1-67]; part 3 «Specimens of the Gabri Dialect» [pp. 68-106]; part 4 «Gabri Vocabulary» [pp. 107-164]. *Rivista degli Studi Orientali*, 16-18, pp. 31-97; pp. 1-39; pp. 1-58.
- Izadpanāh, Hamid (2001). *Farhang-e lori*. Tehrān: Asātir, 1380. 1st ed. 1343/1964.
- Jaba-Justi (1879). Jaba, Auguste. *Dictionnaire kurde-français, publié [...] par [...] Ferdinand Justi*. St.-Pétersbourg: Commissionnaire de l'Académie impériale des sciences.
- Jahani Carina; Nourzaei, Maryam (2011). «A Folktale in Koroshi Dedicated to Joy Edelman». In: *Leksika, ètimologija, jazykovye kontakty* [= Festschrift Edel'man]. Moskva: Akademija Nauk, pp. 62-70.
- Kamioka, Koji; Yamada, Minoru (1979). *Lārestāni Studies 1: Lāri Basic Vocabulary*. Tokyo: Institute for the Study of Languages of Asia and Africa.
- Kerimova, Aza Alimovna; Mamedzade, Achmed Kerimovič; Rastorgueva Vera Sergeevna (1980). *Gilyansko-Russkij slovar'*. Moskva: Nauka.
- Keskin, Mesut (2008). *Zur dialektalen Gliederung des Zazaki* [MA thesis]. Frankfurt.
- Kešāvarz, Keyxosrow (1993). *Farhang-e zartoštiān-e ostān-e Yazd*. Baxš 2-3. Eskilstuna: s.n.
- Kurdoev, Kanat K. (1960). *Kurdsko-russkij slovar'*. Moskva: Gosudarstvennoe izdatel'stvo inostrannyx i nacional'nyx slovarej.
- Kurdoev, Kanat K.; Jusupova, Zara A. (1983). *Kurdsko-russkij slovar' (Sorani)*. Moskva: Russkij Jazyk.
- Lane, Edward W. (1863-1893). *An Arabic-English Lexicon*, vols. 1-8. London: Williams and Norgate. Repr. Beirut 1968.
- Lazard, Gilbert (1963). *La langue des plus anciens monuments de la prose persane*. Paris: Librairie C. Klincksieck.
- Lazard, Gilbert (1990). *Dictionnaire persan-français, par [...], avec l'assistance de Mehdi Ghavam-Nejad*. Leiden: Brill.
- Lecoq, Pierre (2002). *Recherches sur les dialectes kermaniens (Iran central): Grammaire, textes, traductions et glossaires*. Leuven: Peeters. Acta Iranica 39.
- Lorimer, David L.R. (1916). «Notes on the Gabri Dialect of Modern Persian». *Journal of the Royal Asiatic Society*, pp. 423-489.

- MacKenzie, David Neil (1961). *Kurdish Dialect Studies - I*. London: Oxford University Press.
- Malekzāde, Mohammad Ja'far (2001). *Farhang-e Zarqān: Vāženāme-ye lahje-ye fārsi-ye mardom-e Zarqān-e Fārs*. 2nd ed. Tehrān: Farhangestān-e zabān-o-adab-e fārsi, 1380.
- Mayer, Thomas John Lee (1910). *English-Biluchi Dictionary*. Lahore: Sheikh Mubarak Ali.
- Mazdāpur, Katāyun (1995). *Vāženāme-ye guyeš-e Behdinān-e šahr-e Yazd: Fārsi be guyeš bā mesāl: Jeld-e avval (ā-p)*. Tehrān: Pažuhešgāh-e 'olum-e ensāni va motāle'āt-e farhangī, 1374.
- Minorsky, Vladimir (1955). «Addenda to the *Ḥudūd al-Ālam*». *BSOAS*, 17, pp. 250-270.
- Minorsky, Vladimir (1937). *Ḥudūd al-Ālam «The Regions of the World»: A Persian Geography 372 A.H.-982 A.D.* Translated and explained by V. Minorsky with the Preface of V.V. Barthold. London: London: Luzac & Company.
- Mohammadi Xomak, Javād (Sakāi-e Sistāni) (2000). *Vāženāme-ye sakzi (Farhang-e loyāt-e sistāni)*. Tehrān: Soruš, 1379.
- Mo'in, Mohammad (1992). *Farhang-e fārsi (motavasset)*. 6 vols. 8th ed. Tehrān: Mo'assese-ye entešārāt-e Amir Kabir, 1371.
- Moīnfar, Mohammad Dj. (1970). *Le vocabulaire arabe dans le Livre de Rois de Firdausī: Etude philologique et de statistique linguistique*. Wiesbaden: Harrassowitz.
- Monchi-Zadeh, Davoud (1990). *Wörter aus Xurāsān und ihre Herkunft*. Leiden: Brill. Acta Iranica 29.
- Mota'medi, 'Abdolhādi (2001). *Rudān, behešt-e jonub*. Bandar 'Abbās: Našr-e čičiKā, 1380.
- Na'jibi Fini, Behjat (2002). *Barresi-e guyeš-e fini*. Tehrān: Farhangestān-e zabān-o-adab-e fārsi, 1381.
- Partavi Āmoli, Mehdi (1979). *Farhang-e 'avām-e Āmol*. Tehrān: Markaz-e mardomšenāsi-e Irān, 1358.
- Paul, Ludwig (1998). *Zazaki: Grammatik und Versuch einer Dialektologie*. Wiesbaden: Dr. Ludwig Reichert Verlag.
- Paul, Ludwig (2009). «Zazaki». In: Windfuhr, Gernot (ed.), *The Iranian Languages*. Abingdon: Routledge, pp. 545-586.
- Pirejko, Lia Aleksandrovna (1976). *Talyšsko-russkij slovar'*. Moskva: Russkij Jazyk.
- Procházka, Stephan (1993). *Die Präpositionen in den neuarabischen Dialekten*. Wien: VWGÖ.
- Qafisheh, Hamdi A. (1997). *Ntc's Gulf Arabic-english Dictionary: A Compact Dictionary of the Contemporary Arabic of the Mideast*. Lincolnwood (IL): NTC Publishing Group.
- Raverty, Henry G. (1860). *A Dictionary of the Puk'hto, Pus'hto or Language of the Afghāns*. London: Longman.

- Rezāi, Jamāl (1994). *Vāženāme-ye guyeš-e Birjand*. Tehrān: Enteshārāt-e Ruzbehān, 1373.
- Rossi, Adriano V. (1979). *Iranian Lexical Elements in Brāhūi*. Napoli: Istituto Universitario Orientale.
- Rozenfel'd, Anna Z. (1982). *Tadžiksko-russkij dialektnyj slovar' (jugovostočnyj Tađžikistan)*. Leningrad: Izdat. Leningrad. Univ.
- Salāmi, 'Abdonnabi (2002). *Farhang-e guyeš-e davāni*. Tehrān: Farhangestān-e zabān-o-adab-e fārsi, 1381.
- Salāmi, 'Abdonnabi (2004). *Ganjine-ye guyeš-šenāsi-e Fārs, 1, Guyešhā-ye davāni, dahlei, 'abdui, kāzeruni, kalāni, kande'i, kuzargi, mamassani, māsarmi*. Tehrān: Farhangestān-e zabān-o-adab-e fārsi, 1383.
- Salāmi, 'Abdonnabi (2005). *Ganjine-ye guyeš-šenāsi-e Fārs, 2, Guyešhā-ye banāfi, pāpuni, dusirāni, riči, somyāni, kalāni (tājiki), gorganāi / gāvkošaki, mošqāni, nudāni*. Tehrān: Farhangestān-e zabān-o-adab-e fārsi, 1384.
- Salāmi, 'Abdonnabi (2006). *Ganjine-ye guyeš-šenāsi-e Fārs, 3, Guyešhā-ye baliāni, birovakāni, hayāti (dowlatābādi), dādenjāni, lor dārengāni, dorunaki / mehbudi, dežgāhi / guri, koroši, koruni*. Tehrān: Farhangestān-e zabān-o-adab-e fārsi, 1385.
- Salāmi, 'Abdonnabi (2007). *Ganjine-ye guyeš-šenāsi-e Fārs, 4, Guyešhā-ye asiri, aheli, tangkiši, xoŋji, zāxoruye, šowrābi, qalāti, kāriāni, gerāši / zeynalābādi*. Tehrān: Farhangestān-e zabān-o-adab-e fārsi, 1386.
- Salāmi, 'Abdonnabi (2009). *Ganjine-ye guyeš-šenāsi-e Fārs, 5, Guyešhā-ye aškanāni / pāqālāti, evazi, banāruyei, bixei, beyrami, bālādehi, keriški, fedāyi, fišvari, kowrdehi, galedāri, lāri*. Tehrān: Farhangestān-e zabān-o-adab-e fārsi, 1388.
- Sayad Hashmi (2000). *Sayad Ganj*. Karāčī: Balochi Academy.
- Šālči, Amir (1991). *Farhang-e guyeš-e Xorāsān-e bozorg*. Tehrān: Našr-e Markaz, 1370.
- Schmitt, Rüdiger (2014). *Die alt-persischen Inschriften der Achaimeniden: Editio minor mit deutscher Übersetzung*. Wiesbaden: Reichert Verlag.
- Sorušīān, Jamšid Soruš (1956). *Farhang-e behdinān*. Ed. by M. Sotude. Tehrān: Mo'assese-ye Enteshārāt-o-čāp-e Dānešgāh-e Tehrān. Repr. 1370/1991.
- Sotude, Manučehr (1957). *Farhang-e kermāni*. Tehrān: Enteshārāt-e Farhang-e Irānzamin, 1335.
- Sotude, Manučehr (1963). *Farhang-e semnāni, sorxei, lāsgardi, sangsari, šahmerzādi*. Tehrān: Enteshārāt-e Dānešgāh-e Tehrān, 1342.
- Timuri Far, 'Ali (1983). *Guyeš-e damāvandi*. Tehrān: s.n., 1362.
- Todd, Terry Lynn (1985). *A Grammar of Dimilī (also known as Zaza)* [doctoral dissertation]. Ann Arbor: The University of Michigan.
- Trail, Ronald. L.; Cooper, Gregory R. (1999). *Kalasha Dictionary with English and Urdu*. Islamabad: National Institute of Pakistan Studies, Quaid-i-Azam University.

- Vahman, Fereyduṅ; Asatrian, Garnik (2002). *Notes on the Language and Ethnography of the Zoroastrians of Yazd*. Copenhagen: Det Kongelige Danske Videnskabernes Selskab.
- VAI (1966-1973). *Vocabolario arabo-italiano*. 3 voll. [vol. 1, 1966; vol. 2, 1969; vol. 3, 1973]. Roma: Istituto per l'Oriente.
- Wehr, Hans (1979). *A Dictionary of Modern Written Arabic (Arabic-English)*. Ed. by J. Milton Cowan. 4th ed. Wiesbaden: Harrassowitz.
- Zammit, Martin R. (2002). *A Comparative Lexical Study of Qur'ānic Arabic*. Leiden; Boston; Köln: Brill.
- Zomorrodīān, Rezā (1989). *Barresi-e guyeš-e Qāin. Āstān-e Qods-e Rezavi: Mo'āvenat-e farhangi-e Āstān-e Qods-e Rezavi*, 1368.

## **2 Inspecting Perimeters**



## Borders

Itineraries on the Edges of Iran

edited by Stefano Pellò

# If these Walls Could Speak The Barrier of Alexander, Wall of Darband and Other Defensive Moats

Touraj Daryaee

(University of California, Irvine, USA)

**Abstract** This essay provides a brief discussion of the views of the Sasanians about the limits of their empire from the third to the seventh century CE. The walls created on the boundaries of the empire from the first century of its existence to the final brick in the wall in the sixth provides an image of Iranshahr. The material culture is set aside the literary evidence and their differences and ideological values are highlighted.

**Keywords** Sasanians. Iranshahr. Defensive moat. Barrier.

In Memory of Gherardo Gnoli

In antiquity, several civilizations built walls for creating a barrier between what they considered their territory and that of the outsiders. The most famous of these are the Hadrian Wall built by the Romans and the Great Wall of China, which protected the Roman Empire from the west and the Chinese realm from the north against the nomadic incursions. A lesser known wall system is the one built by the Sasanians from the fifth century CE onward. Unlike the other two walls, the Sasanians built several walls around their empire, which protected them from the Huns, the Turks and the Arabs. Of course since the Achaemenid Empire, Median *paradaiza* (Old Persian *paradaida*, Greek παράδεισοι) has carried with it a huge ideological significance (Panaino 2012, p. 150). In this essay, in addition to mentioning the importance of the walls themselves, the political and ideological significance of such a building project will be discussed. It will be posited that walls not only provided a physical protection against the others, but also suggested a mental projection of those within the civi-

I would like to thank Keenan Baca-Winters (UC Irvine), Sam Behseta (CSU Fullerton), Khodadad Rezakhani (London School of Economics) and Babak Shahbaba (UC Irvine) for their comments on the paper.

---

### Eurasiatica 5

DOI 10.14277/6969-100-3/EUR-5-4

ISBN [ebook] 978-88-6969-100-3 | ISBN [print] 978-88-6969-101-0 | © 2016

lized (inside/*ēr*) and the un-civilized (outside/*an-ēr*) realms, something that served to regulate the inevitable interaction between the two.<sup>1</sup>

The textual and archaeological data suggest that the Sasanians built four walls: 1) The Barrier of Alexander (Wall of Gorgan); 2) the Wall of Tammishe; 3) the Alān Gates (Darband); and 4) the Wall of the Arabs. Of these walls, three are demarcating the northern (north-west and north-east) limits of the Sasanian Empire and one is a barrier in the south-west. They are mainly next to the two bodies of waters, the Caspian Sea and the Persian Gulf. Thus, seas and walls were the true defense for the limits of the empire.

The two walls in the northwest are known as the Great Wall of Gorgan and the Wall of Tammishe. The Wall of Gorgan, also known as *Sadd-ī Iskandar*, runs across the Turkmen steppe from the Caspian Sea to the mountains. It is about 195 km. long with some 33 forts, along with gates and in fact is the longest continuous wall built in antiquity (Nokandeh et al. 2007, p. 127). Its beginning is dated to the fifth century, continuing into the early sixth CE, no doubt a defensive mechanism against the Hephthalites and other nomadic people pressing on the northeastern borders of the Sasanian Empire (p. 163). We know that in the fifth century CE, the Sasanian Empire faced a difficult challenge from the Hephthalites. The King of Kings Pērōz met a powerful army of the Hephthalites in 469 CE, where his harem was captured. Finally in 484 CE, Pērōz lost his life along with seven of his sons and his entire army (Daryaee 2009, p. 25). No doubt, these events must have prompted the Sasanians to think of a defense mechanism against the invaders; it seems that the walls were indeed an effective security measure against the threats in this region (p. 167).

The Wall of Tammishe is the other important wall in the same region, which runs from the southeast corner of the Caspian Sea into the foothills of the Alborz mountains. The excavation report suggests that it was also built during the Sasanian period (Bivar, Fehèrvéri 1966, p. 40). Textual sources such as Yāqūt and Tabarī associate this wall with the time of Khusro I (mid-sixth century CE). According to Yāqūt, Tamīs was also a city in Tabaristan area close to Sarī. He goes on to describe the place as:

At this place there is a great portal, and it is not possible for any of the people of Tabaristan to depart from there to Jurjān except through the portal, because it extends from the mountains to the sea, (it is made) of baked brick and gypsum. It was Kisrā Anūšīrvān who built it as an obstacle against the Turks and their raids into Tabaristan. (Yāqūt 1866-1873, 3, p. 574, quoted in Mahamedi 2004, p. 147)

---

1 Contact is inevitable and the gates of the defensive walls simply point to the fact that the Sasanians attempted at maintaining and controlling it.



The third wall is located on the western side of the Caspian Sea, built by the Sasanians during the reign of Kawād I and later Khusro I in the fifth and sixth century CE (Artamonov 1962, p. 122). The Darband Wall was a project for whose upkeep, the Romans also provided a subsidy, as nomadic raids endangered both empires. The Darband Wall (also known as *bāb al-alān* [Alan Gates]), was at least 40 km long going into wooded areas and impassable mountains. It had seven gates and some twenty-seven towers in the intervals of 170-200 m and its construction was considered by the Arabs as one of the wonders of the world. Its more interesting feature is that it has at least twenty-five Middle Persian inscriptions on it, dated to the sixth century CE (Kettenhofen 1994). We also learn of the name of the accountant (*amārgar*) who commissioned some of these inscriptions, Bazniš ī Ādūrbādagān. Balādhurī states that:

Kisra Anūšīrwān... built the city of al-Bāb u'l-Abwāb, and this name was given to it because its fortifications comprised the gate to several mountain passes. (Mahamedi 2004, p. 151)

This wall was important in that it protected both the Sasanians and the Romans from nomadic incursions into the Caucasus. Priscus in the fifth century CE reports that:

There was also an embassy from the Persian king complaining that some of their people were seeking refuge with the Romans... They also request that the Romans contributed money for maintaining the fortress Iuroepiaach, which is situated by the Caspian Gates, or at least commanded soldiers to its protection because they would no longer bear the costs and protection of the place by themselves. (Dignas, Winter 2007, p. 193)

The last and far less known defensive system is called *Khandaq-ī Šāpūr* in the Perso-Arabic sources and *War ī Tāzīgān* (Wall of the Arabs) in Middle Persian Sources. The *Šahrestānīhā-ī Ērānšahr* mistakenly confuses Šābuhr I for Šābuhr II as the builder and states (ŠĒ 25):

*Šahrestān ī hērt šābuhr ī ardaxšīrān kard, u-š mihrzād ī hērt marzbān pad war ī tāzīgān be gumārd*

The city of Hīra was built by Šāpūr, the son of Ardaxšīr, and he appointed Mihrzād as the margrave of Hīrā over the Wall of the Arabs. (Daryaei 2009, p. 18)

The Sasanians appear to have controlled the region by appointing a margrave (*marzbān*) over the wall, where in the second half of the Sasanian rule, the Lakhmid/Nasrid chiefs also became its protector (Fisher 2011, p. 185). They were placed to defend the area from the Romans and their

client kingdom of the Ghassanids. By such a scheme the Sasanians, no doubt were protecting the agricultural lands of Sasanian Mesopotamia from the Bedouins of Arabia (Bosworth 2003). We should also remind ourselves that Hira is just west of the Euphrates, the river boundary of the Sasanian-Roman world. The Wall of the Arabs was important enough that a *Marzbān* 'Margrave' was appointed to it (ŠĒ 52). Yāqūt states that:

Khandaq-ī Sābūr is in Bariyata al-Kufa, as was dug by the order of Sābūr to separate his (realm) from that of the Arabs, for fear of their raids. Sābūr the Lord of Shoulders (Šāpūr II), built and made frontier watchtowers to protect the areas that laid near the desert, and ordered a moat (*Khandaq*) to be dug from the lower region of the desert to what precedes Basra, and is joined to the sea (Persian Gulf). There, he built turrets and forts and arranged frontier watchtowers, so that the moat could be the barrier between the inhabitants of the desert and the people of as-Sawād. (Yāqūt 1866-1973, 2, p. 65)

I believe that H. Mahamedi has convincingly demonstrated that *khandaq* not only takes on the sense of a 'moat' or 'trench', but also that of the 'wall'. Thus, a wall seems to have been built from the Persian Gulf to the Basra area already in the fourth century CE as the result of Arab Bedouin raids into the Sasanian *Ērānšahr*'s agricultural lands.

## The Symbolic and Psychological Meaning of the Wall

I would like to take the discussion into a different direction and propose the ideological meaning and importance of walls for the Sasanians.<sup>2</sup> The recent work by B. Lincoln has provided a new insight into the mind-set and ideology of the Achaemenid Empire (Lincoln 2012). One of the important observations by Lincoln is that the Old Persian *\*pariadaida*, a walled garden, not only had a profane meaning, but also carried its sacred connotation, that is a paradise in the Christian sense of the word already in the Achaemenid period (2012, pp. 8-9; Lincoln 2003, p. 145). This paradise, a walled garden, was a cosmographical framing by which the Achaemenids were attempting to spread throughout their empire (Old Persian *būmi*). (Lincoln 2012, p. 194; 2007, pp. 70-71).

---

2 The author is using some of his experience, as he lives in what is sometimes called behind the 'Orange Curtain', which is really an ideological boundary between the more liberal Los Angeles and conservative Orange County, California.

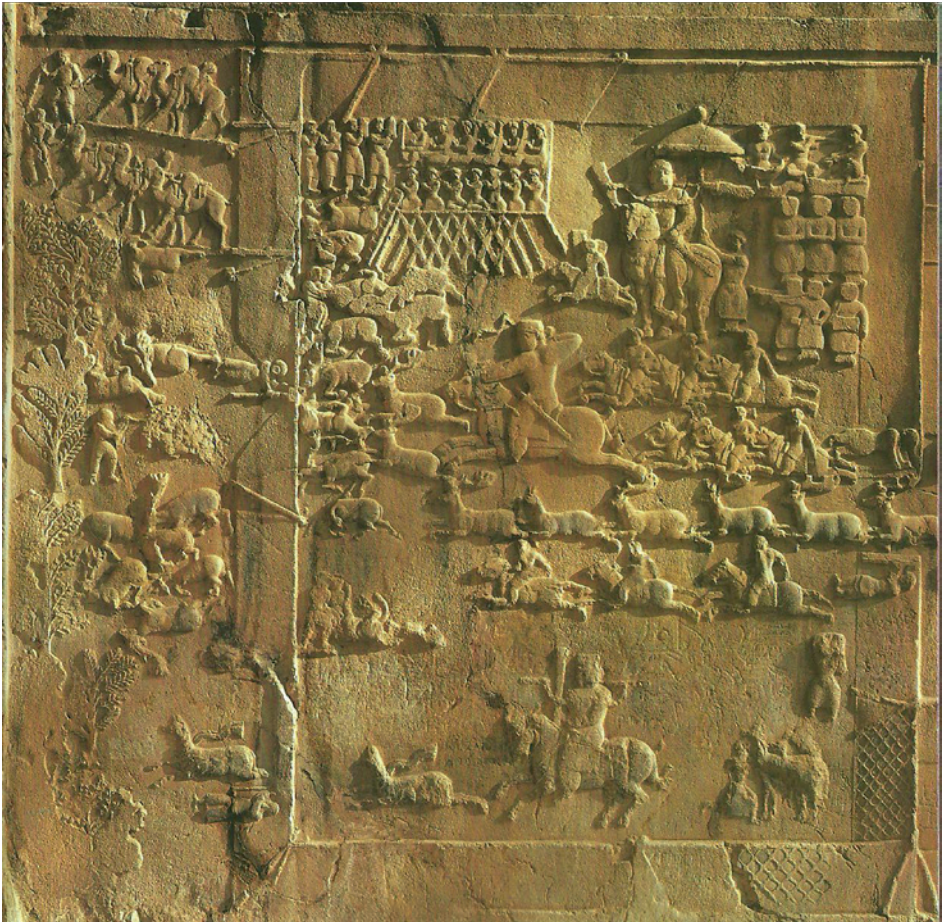

Figure 1. Tāq-i Bustān. Photo by Ali Matin

It is important to note that some notions of *pariadaida*, Persian (*pālīz/ferdows*)<sup>3</sup> was in existence in the Sasanian period, where for example in the relief of Khusro II at Tāq-i Bustān, one may have a pictorial imagery of it.<sup>4</sup> So the concept may also have been in existence in late antiquity. However, protecting such space which was at times imagined as a garden or orchard was only part of the royal realm and the duties of its adminis-

3 Cf. Lincoln 2012, p. 5. One should also notice the Persian *bāy ī ferdows*, a ‘paradise garden’.

4 This may be considered of course a *wiškar* ‘hunting ground’.

trators. Interestingly, in a Middle Persian apocalyptic poem, *bāy ud bōstān* (gardens and orchards) of *Ērānšhar* are alleged to have been confiscated by the Arabs.<sup>5</sup> I would suggest that ideologically, for the Sasanians, the walls at the corners of the Sasanian world symbolically provided a protected garden or orchard, in fact the empire itself, which they kept safe from outsiders.

The best evidence for the idea that *Ērānšahr* is an enclosure and an orchard which must be defended from others, is provided in the *Šāhnāme* of Ferdowsī in the section dealing with the seventh century Sasanian Empire. The idea of being defended is given as such:

Iran is like a lush Spring garden  
Where Roses ever bloom  
The army and weapons are the garden's walls  
And lances its wall of thorns  
If the garden's walls (دیوار) are pulled down  
Then there would be no difference between it and the wilderness  
[beyond]

Take care not to destroy its walls  
And not to dishearten or weaken Iranians  
If you do, then raiding and pillaging will follow  
And also the battle-cries of riders and the din of war  
Risk not the safety of the Iranians' wives, children, and lands  
by bad policies and plans  
(Omidasalar 2012, pp. 165-166; Ferdowsī 1998-2008, 8, pp. 275-282).<sup>6</sup>

Thus, I would like to propose a mental meaning for walls of the Iranian world, most probably similar to other civilizations that built walls in antiquity, but also modern walls and defenses. Not only Hadrians' Wall, the Great China wall, but also the wall built by Israel and the one in Ireland and more recently the proposed wall by the US with its border with Mexico have huge symbolic, ideological and political meanings. Walls are meant to provide safety from the outsiders, but this 'protection' also attempts to separate those on the other side from those within the walls. Another example is the idea of 'gated community' which now roughly houses ten percent of the American population. The population in these gated communities tends to be not only economically well off, but more importantly

---

5 For the latest translation of this Pahlavi poem see Daryaei 2012, pp. 10-11.

6 The glossing and changes in the translation of the text in the book and what I have quoted here is done by Omidasalar.

ethnically white.<sup>7</sup> These gated walled enclosures in a sense attempt to restrict contact with those outside, which in turn tends to make the outsiders demonized.

This idea also bodes well with Jeffrey Cohen's monster theory that those on the outside represent the other (1996, pp. 3-25). A good example can be found in the *Tārīkh-e Sīstān*, where the leader of the Arab armies in the seventh century CE, Rabi', who is set to conquer the province of Sīstān is described as a tall, dark man with big teeth and big lips sitting on corpse (*nasā*) of men. The leader of the Iranian forces sees Arab general and at once suggest that it is believed that Ahriman (i.e., the Evil Sprit), who is thought not have a form, now he has appeared before them in the flesh! (Anon. 1935, p. 82). If we follow Carlo Cereti's reading, the Arabs are also mentioned in Sasanian Middle Persian texts as *gurg ī dō zang* 'two legged-wolves' (Cereti 1995, p. 207), which regardless of its earlier *männerbund* connotation,<sup>8</sup> here provides an old Iranian topos which may go back to the Avestan interpolation of two legged Marya (*männerbund*) and wolves and other monsters (Yasna 9.18). (Kellens 2007, pp. 59-60; also Pirart 2007, pp. 76-77).

One could suggest that these outsiders or others are simply *an-ēr* were the anthesis of the *ēr* or Iranians, who with their *ērīh* and other values were protected within the walls (Gnoli 1989, pp. 147-148). The nomadic outsiders, be it Huns, Arabs, Hephthalites or the Turks, did not have a similar notion of boundary (Barth 1969, pp. 19-20), but walls built by the Sasanians provided limits for security, as barriers against them (pp. 27-28). These barriers or walls had a psychological resonance. While it isolated the Arabs, Hephthalites and Turks from *Ērānšahr*, it also helped solidify a sense of togetherness in what F. Barth calls a polyethnic social system (pp. 16-17). The late G. Gnoli has written much in regard to the formation of Iranian identity, and according to him it is only from the third century CE on that such an identity, where the ethnic, linguistic and religious values were put into motion in order to created a 'political import' meaning and Iranian empire (Gnoli 2006). He also suggests that it is in the sixth century CE, during the reign of Khusro Anūšagruwān (531-579 CE) that we find the final stage of the political program backed by the aristocracy, warrior class and the Zoroastrian priesthood (Gnoli 2006). Of course, this is the time that walls around the empire are fully built and in operation.

Thus, one can conclude that in a way the walls helped create, or main-

7 For the most recent and fascinating study see, Benjamin 2009. For a brief commentary see his *The Gated Community Mentality*, in *The New York Times* (2012).

8 The classic treatment is by Stig Wikander (1938). The most recent comprehensive treatment in the Indo-European world is by K. McCone (1987).



tain an identity as a place where *ērānagān* (Iranians) dwelled, where sweet orchards existed, while the monstrous 'others' in the Cohenian sense of the word, dwelled at the edges and outside the empire. This vision and attitude made walls a perfect means for boundary and identity maintenance<sup>9</sup> in the Sasanian period, at a time where the idea of Iran became a political reality and its ideological effect took full form, something that was to last beyond the life span of the late antique empire. What is important is that the wall also provided a psychological and ideological effect for the rulers and those ruled and living within the *Ērānšahr*. This mind-set, although challenged through the ages and after the walls had come down, have provided a sense of being and a mode of differentiation for some on the Iranian Plateau.

## Bibliography

- Anon. (1935). *Tārīkh-e Sīstān*. Ed. by Mohammad Taqi Bahār. Tehrān: Khāvar, 1314.
- Artamonov, Michail Illarionovich (1962). *Istoriya Khazar*. Leningrad: Nauka.
- Barth, Fredrik (1969). «Introduction». In: Barth, F. (ed.), *Ethnic Groups and Boundaries: The Social Organization of Culture Difference*. Boston: Little, Brown & Co., pp. 9-37.
- Benjamin, Rich (2009). *Searching for Whitopia: An Improbable Journey to the Heart of White America*. New York: Hyperion.
- Benjamin, Rich (2012). «The Gated Community Mentality» [online]. *The New York Times*, 29th March. Available at [http://www.nytimes.com/2012/03/30/opinion/the-gated-community-mentality.html?\\_r=0](http://www.nytimes.com/2012/03/30/opinion/the-gated-community-mentality.html?_r=0) (2014-01-15).
- Bivar, Adrian David Hugh; Fehèrvéri, Geza (1966). «The Walls of Tam-misha». *Iran*, 4, pp. 35-50.
- Bosworth, Edmund C. (2003). «Hira». In: *Encyclopaedia Iranica* [online]. Ed. by E. Yarshater. Available at <http://www.iranicaonline.org/articles/hira> (2014-01-15).
- Cereti, Carlo G. (1995). *The Zand ī Wahman Yasn: A Zoroastrian Apocalypse*. Roma: IsMEO.
- Cohen, Jeffrey Jerome (1996). «Monster Culture (Seven Theses)». In: *Monster Theory: Reading Culture*. Ed. by Jeffrey Jerome Cohen. Minneapolis: University of Minnesota Press, pp. 3-25.
- Daryaei, Touraj (2009). *Sasanian Persia: The Rise and Fall of an Empire*. New York; London: IB Tauris.

---

9 For the idea of boundary maintenance in a communal sense see Sizgorich 2009, ch. 1.

- Daryaei, Touraj (2012). «On the Coming of a Zoroastrian Messiah: A Middle Persian Poem on History and Apocalypticism in Early Medieval Islamic Iran». In: Ahmadi, Wali (ed.), *Converging Zones: Persian Literary Tradition and the Writing of History: Studies in Honor of Amin Banani*. Costa Mesa (CA): Mazda Publishers, pp. 5-14.
- Dignas, Beate; Winter, Engelbert (2007). *Rome and Persia in Late Antiquity: Neighbours and Rivals*. Cambridge: Cambridge University Press.
- Ferdowsī, Abu 'l-Qāsem (1988-2008). *Shāhnāma*. Ed. by Jalāl Khāliqī Muṭlaq. 8 vols. New York: Bibliotheca Persica.
- Fisher, Greg (2011). *Between Empires: Arabs, Romans, and Sasanians in Late Antiquity*. Oxford: Oxford University Press.
- Gnoli, Gherardo (2006). «Iranian Identity ii: Pre-Islamic Period» [online]. In: *Encyclopaedia Iranica*. Ed. by Ehsan Yarshater. Available at <http://www.iranicaonline.org/articles/iranian-identity-ii-pre-islamic-period> (2014-01-15).
- Gnoli, Gherardo (1989). *The Idea of Iran: An Essay on its Origin*. Roma: IsMEO.
- Kellens, Jean (2007). *Le Hōm Stōm et la zone des déclarations (Y7.24-Y15.4, avec les intercalations de Vr3 à 6)*. Paris: Éditions de Boccard. Études avestiques et mazdéennes vol. 2, Persika 10.
- Kettenhofen, Erich (1994). «Darband». In: *Encyclopaedia Iranica* [online]. Ed. by Ehsan Yarshater. Available at <http://www.iranicaonline.org/articles/darband-i-ancient-city> (2014-07-15).
- Lincoln, Bruce (2003). «À la recherche du paradis perdu». *History of Religions*, 43, pp. 139-154.
- Lincoln, Bruce (2007). *Religion, Empire & Torture: The Case of Achaemenian Persia, with a Postscript on Abu Ghuraib*. Chicago: Chicago University Press, pp. 70-71.
- Lincoln, Bruce (2012). 'Happiness for Mankind' *Achaemenian Religion and the Imperial Project*. Leuven-Paris-Walpole: Peeters. Acta Iranica, 53.
- Mahamedi, Hamid (2004). «Wall as a System of Frontier Defense». In: Daryaei, Touraj; Omidsalar, Mahmoud (eds.), *The Spirit of Wisdom: Essays in Memory of Ahmad Tafazzoli*. Costa Mesa (CA): Mazda Publishers.
- McCone, Kim R. (1987). «Hund, Wolf und Krieger bei den Indogermanen». In: Meid, Wolfgang (Hrsg.), *Studien zum Indogermanischen Wortschatz*. Innsbruck: University of Innsbruck Press, pp. 101-154.
- Nokandeh, Jebrael et al. (2006). «Linear Barriers of Northern Iran: The Great Wall of Gorgan and the Wall of Tammishe». *Iran*, 44, pp. 121-173.
- Omidsalar, Mahmoud (2012). *Iran's Epic and America's Empire: A Handbook for A Generation in Limbo*. Santa Monica: Afshar Publishing.
- Panaino, Antonio (2012). «No Room for the 'Paradise'? About Old Persian <Pa-ra-da-ya-da-a-ma>». In: Basello, Gian Pietro; Rossi, Adriano V. (eds.), *Dariosh Studies II: Persepolis and Its Settlements: Territorial*

*System and Ideology in the Achaemenid State*. Napoli: Università degli Studi di Napoli «L'Orientale», pp. 139-153.

Pirart, Éric (2007). *L'éloge mazdéen de l'ivresses*. Paris: L'Harmattan.

Sizgorich, Thomas (2009). *Violence and Belief in Late Antiquity: Militant Devotion in Christianity and Islam*. Philadelphia: University of Pennsylvania Press.

Wikander, Stig (1938). *Der arische Männerbund: Studien zur indo-iranischen Sprach- und Religionsgeschichte, Doktorsavhandling*. Lund: Håkan Ohlssons Buchdruckerei.

Yāqut (1866-1873). *Jacut's Geographisches Wörterbuch: Aus den Handschriften zu Berlin, St. Petersburg, Paris, London und Oxford*. Herausgegeben von Ferdinand Wüstenfeld. 6 Bd. Leipzig: In commission bei F.A. Brockhaus.



## Borders

Itineraries on the Edges of Iran

edited by Stefano Pellò

# Cycles and Circumferences

## The Tower of Gonbad-e Kāvus as a Time-measuring Monument

Simone Cristoforetti

(Università Ca' Foscari Venezia, Italia)

**Abstract** The focus is on the tower of Qābūs ibn Wušmgīr, Ziyarid ruler of Gīlān between the tenth and the eleventh century CE. In spite of the archaeological evidence, the monument is still considered as a *mausoleum* by most scholars. However, the tower's geometrical and mathematical features can reveal the outstanding significance of the building as a time-measuring monument. A new interpretative key for the well-known tower of Gonbad-e Kāvus, based on the major time-reckoning cycles of Iranian world, is proposed. On this basis, it is possible to see how the building quite satisfies three needs at least: a need for dynastical propaganda, an administrative need in a fiscal equality perspective, and an Islamic orthodox need, as far as the accuracy of the daily prayer is concerned.

**Keywords** Gonbad-e Kāvus. Qābūs ibn Wušmgīr. Iranian calendar. Ziyarids.

به وقت هندسه عبرت‌نمایی  
مجسطیدان و اقلیدس‌گشایی  
(Nizāmī, *Qiṣṣa-yi Farhād*)

The building under discussion here is located in the Caspian region, in the Iranian city now referred to officially as Gonbad-e Kāvus – the ancient Jurjān/Gurgān<sup>1</sup> – where the well-known tower of the amīr Qābūs ibn Wušmgīr<sup>2</sup> stands.

Scholars who have examined this building (figs. 1-3) and already referred to the singular star-shape of the plan and its conical roof, all agree about its probable astronomical-astrological meaning. However, no one has yet managed to identify any revealing element that could allow such an understanding of the monument.

1 On the history of the city, see Le Strange 1905, pp. 377-379, and Godard 1939, pp. 967-970. I take this chance to thank Emilio Secchi for his most precious advice and help in analysing the tower of Qābūs and elaborating figs. 4-5 and 7.

2 Ruled from 367/978 to 371/981 and from 387/997 to 402/1012 (371-387/981-997 Buwayhid occupation). See Bosworth 1996, pp. 166-167.

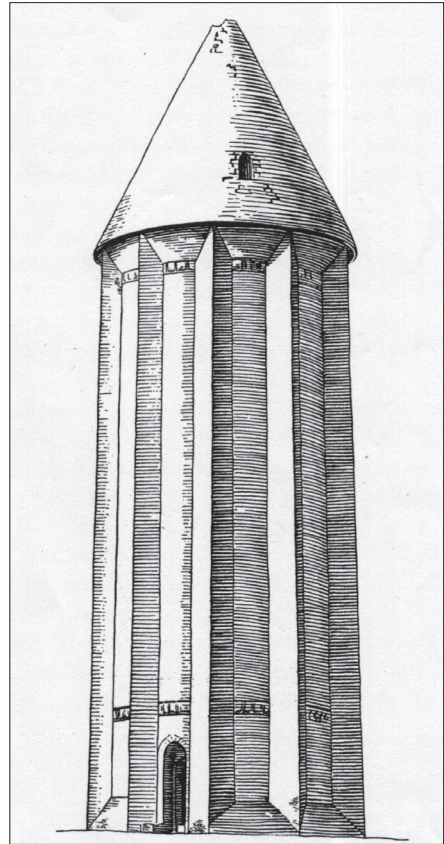

Figure 1. Front of the Gonbad-e Kāvus tower (Godard 1939, p. 974, fig. 336)

With regard to its patronage, it is easy to note that the *laqab* of the prince Qābūs ibn Wušmgīr, as well known titled *shams al-ma'ālī*, definitely alludes to a sort of vocation for a 'rise'; as Sheila Blair says: «the solar date» - which appears for the first time in a monumental inscription on this tower - «was an apt literary allusion to Qabus's title *shams al-ma'ālī* (sun of eminences)» (Blair 1992, p. 65). Can we only talk about a 'literary allusion', or, behind that first official inscription, is there something else?

The building is famous most of all for the awing, spectacular effect produced by its rocket-shape standing out from the flat land around with a height of 52.8 meters and based on a 10-meter-high embankment. Referring to the well-known ability of the Ziyarid ruler as an expert calligrapher<sup>3</sup> and

3 The *Nawrūznāma*, a *risāla* of miscellaneous contents composed about a century after the building of the tower hereby at hand, states: *Ba zamīn-i 'Irāq dawāzdah qalam-ast [...] wa har yak-i rā ba buzurg-i az kaṭṭātān bāz kwānand [...] yak-i rā šifat kunīm wa ān qalam-i šamsī ast wa qalam-i Šams al-Ma'ālī [...]*. «On the 'Irāq land, they use twelve types of calam



Figure 2. View of the Gonbad-e Kāvus tower from south

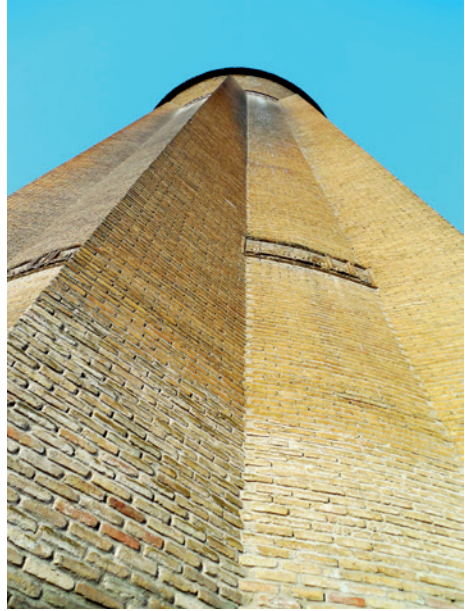

Figure 3. The vertical 'rise' of the Gonbad-e Kāvus tower from north-east

a skilful astronomer, Blair states that «these interest and avocations clearly played a role in the design of the Gunbad-i Qabus» (Blair 1992, p. 65). But what sort of 'role'? I would like to focus mainly on these questions.

The building was excavated by a czarist military detachment under the command of I.G. Poslavskij at the end of nineteenth century, in order to establish the existence of an underlying burial chamber, but no tomb was discovered (Diez 1918, 1, p. 42).<sup>4</sup> Then, the prince was not buried there; he was not buried under the level of the tower internal floor either. Was he buried upstairs as al-Jannābī (sixteenth century) suggests? And how?

According to al-Jannābī, the body of the Ziyarid amir Qābūs ibn Wušmgīr was laid into a crystal coffin filled with aloe and suspended by means

[...] and each one of these takes the name from a famous calligrapher [...]. We now describe one and it is the *šamsī* calām. The calām of Šams al-Ma'āli [...]» (MS Cod. Or. 8° nr. 2450, f. 96a SB Berlin; lacuna in the MS Add. 23568 BM London).

<sup>4</sup> A French abridgement of the Poslavskij's Russian text by Ernst Diez is available in Diez 1918, 1, pp. 41-43; the Poslavskij's original, entitled *Iz poezdki na r. Atrek i Gjurgjen*, was published in 1900 in the 5th volume of the *Protokol' turkestanskogo kruška ljubitelej archeologii*.

of chains from the vault of the tower he built as his own mausoleum.<sup>5</sup> This fascinating hypothesis given by such a late source is not trustful (Bartol'd 1966, p. 265 n. 22), because no evidence of any fixing points of the hanging chains has ever been found. The use of this topos<sup>6</sup> may have been suggested to al-Jannābī by the extraordinary height of the building and its singular star-shape; nevertheless, it could also be due just to the apparent absence of any sort of burial structures.

The archaeological evidence notwithstanding, most scholars still consider the building as a *mausoleum*.<sup>7</sup> However, as correctly observed by Bartol'd, the Arabic word corresponding to Persian *gunbad* (which, together with the prince's name allegedly buried there, obliterated the ancient city's name) is *qubba*, whereas the term which appears in the inscription is Arabic *qaṣr* (from Gr. κάστρον, Lat. *castrum*), meaning 'castle', 'palace', and never with the meaning 'mausoleum' or 'tomb' (1966, p. 265). In his article, where he provides a complete and comprehensive survey of all the literature on the subject which had appeared up to his time, Bartol'd discusses the burial function of the tower, referring also to O'Donovan's observations about the tower in Rādkān (*The Merv Oasis*, 2, pp. 22-24; *non vidi*); according to O'Donovan, this latter tower could be neither a tomb nor a place to live in because of the lack of architectural openings in the upper part of the building, as it also happens in other so-called 'mausoleums' in eastern Anatolia and in Kars. On this basis, Bartol'd notes that the very existence of an upper opening in Qābūs' tower excludes the possibility that it could be something different from a tomb. Despite Bartol'd's opinion, I think that the prospect of possible different functions of buildings similar to mausoleums is not necessarily questioned by the presence of a window in the tower, which can have a precise role underlining the importance of the east-west orientation of the building.

5 The statement by al-Jannābī is written in his *Badāyi' al-āṭār fī nawādir al-ḥikāyāt*. The text, in Bernhard Dorn's German translation, is in Diez 1918, 1, p. 40; many other sources on the monument are recorded there. In this regard, Francesco Noci states that, probably according to an ancient custom, the window on the eastern side of the roof may have been designed for the exposure of the prince's body to the first sunbeams (2002, p. 841).

6 The topos of the suspended coffin was already known to the Jewish traveller Benjamin of Tudela, who, in 1160, saw prophet Daniel's coffin suspended from the arch of the bridge in Susa (van Berchem 1918, p. 102 n. 2, who also points to two other cases). About the suspended (*mu'allaq*) coffin supposedly containing Aristotle's remains and located in a former church converted into a mosque described by Ibn Ḥawqal (end of the tenth century), see Vanoli 2008, pp. 247-253.

7 «Gonbad-e Qābus is a tall tower that marks the grave of the Ziyarid ruler Qābus b. Vošmgir» (Blair 2003, p. 129); see also Noci 2008. The monument is described as a tomb also in its inscription on the World Heritage List (see <http://whc.unesco.org/en/list/1398> [2015-12-30]).

In comparison to similar more or less coeval monuments, the tower is extraordinarily high. In its simplicity of lines and conception, no doubt it is the result of an attentive project work, as the system adopted for the joints between the flanges and the central body, and the bricks shape of the perfectly conic cupola (Godard 1939, pp. 972-973; for some corrections about the building measures, see Bulatov 1978, pp. 90-92), and the formal stylistic refinement of the inscriptions definitely testify (Blair 1965, p. 65). The imposing walls and the fine quality of the material clearly indicate that the tower was conceived that way to last over time, and, if it endured over nine centuries before restoration was needed of the eroded base, due to the breaking of some bricks because of the excessive weight from above, one can say that the patron's expectations have been certainly and largely satisfied.

Two encircling Kufic inscriptions on ten brick cartouches are located approximately two meters below the conic roof and eight meters above the ground. By starting from the east bands, the inscriptions underline the importance of the east-west orientation of the entire building marked by the window. The two inscriptions give the same text. Its translation is as follows:

In the name of God, the Beneficent, the Merciful. This is the high palace by the prince Šams al-Ma'ālī (Sun of the Eminences), the prince son of prince, Qābūs son of Wušmgīr. He ordered the construction of the building during his life, in the lunar year three hundred ninety seven [27 September 1006-16 September 1007] and the solar year three hundred seventy five [15 March 1006-14 March 1007].<sup>8</sup>

These inscriptions reveal the patent willingness to provide such type of information and nothing else. More than signs of ancient paganism counterfeited under apotropaic-dedicatory astrological intents – as assumed by Max van Berchem (quoted in Blair 1965, p. 106) – they recall instances of astronomical-calendrical type certainly connected with the ancient tradition as well.

The Ziyarid amir had a glorious ancestry ascending to Arġuš-i Farhādān,<sup>9</sup> lord of Gīlān at the time of Kay Ƙusraw, in which Sa'īd Nafisī (1968, pp. 201-

<sup>8</sup> The Arabic text is as follows: *Bismillāh al-raḥman al-raḥīm | haḍā al-qaṣr al-'ālī | li-'l-amīr šams al-ma'ālī | al-amīr ibn al-amīr | Qābūs ibn Wušmgīr | amara bi-binā'i-hi fī ḥayāti-hi | sana saba' wa tis'in | wa ṭalaṭami'a qamariyya | wa sana ḳams wa saba'in | wa ṭalaṭami'a šamsiyya.*

<sup>9</sup> Or Āġuš son of Wahādān, according to the *Qābūs-nāma* by Kay Kā'ūs ibn Iskandar, nephew of Qābūs ibn Wušmgīr; see Kay Kā'ūs ibn Iskandar 1981, pp. 14-15. On the Ziyarid dynasty, see Justi 1895, p. 431; Rabino 1936, p. 416; Zambaur 1927, pp. 189, 211. A clear and well-traced genealogy of the Ziyarid lineage by Riccardo Zipoli is available in Kay Kā'ūs ibn Iskandar 1981, unnumbered page at the end of the book.

203) tries to identify Āraš, the mythical archer who established the Iranic *space*. Less legendary is Qābūs' paternal uncle, the well-known Mardāwīj ibn Ziyār (315-323/927-935), founder of the family fortunes.<sup>10</sup> Like a new Khosrow, he is credited by Ibn Miskawayh with the intention of restoring the Sasanian *īwān* in ancient Ctesiphon (al-Madā'in), also known as Ṭāq-i Kisrā.<sup>11</sup> It should be remembered that the first historical information on a celebration of the Iranian Sada fire-festival occurs in the sources relating to the dramatic death of Mardāwīj (Cristoforetti 2002, pp. 118-126). Qābūs was the younger son of Māhān the Great (r. 323-357/935-967), best known to the scholars with his nickname Wušmgīr, the Quail-catcher,<sup>12</sup> who in the

10 Mardāwīj ibn Ziyār was a Jilite soldier of fortune, who, during the rebellion of a Samanid general, took the opportunity to conquer most of northern Persia, and soon Iṣfahān and Hamadān. Under Wušmgīr ibn Ziyār (323-357/935-967) and his successor Bisutūn (357-366/967-977), they acknowledged the sovereignty now of the Samanids, now of the latter's rivals the Buwayhids; but in the reign of Qābūs ibn Wušmgīr they lost Ṭabaristān and Gurgān to the Buwayhids, who remained in control of the region until 388/998; see Bosworth 1965 and 1996, p. 166; Madelung 1975, pp. 212-215.

11 See Ibn Miskawayh 1914, p. 317 (Arabic text); Ibn Miskawayh 1921, p. 359 (English trans.). The Arabic text preserves a note by al-Šūlī, who attributes to Mardāwīj the following statement: «I will bring back the power of the Persians and I will destroy the power of the Arabs» (Ibn Miskawayh 1914, p. 317 n. 1).

12 On the basis of *Nawrūznāma*, I can say, with some certainty, that Māhān the Great is the proper name of the Ziyārid ruler known as Wušmgīr. The author of *Nawrūznāma* ascribes to him the composition of a voluminous work on falconry written in *kūhī* language (probably the *ṭabarī* language). I transcribe here the relevant passage found in the Berlin MS (f. 98<sup>b</sup>; the chapter on falconry is missing in the London MS). It might prove useful because some parts of it were misunderstood by M. Mīnawī (*Nawrūznāma* A, p. 57), by the authors of the Russian translation (where Badr ibn Ḥasanūya's - or Ḥasanwayh's - name is not properly interpreted, and where it's not even considered that Māhān is the name of Wušmgīr; see *Nawrūznāma* B, p. 214), and by other Iranian scholars who edited this work as, for example, 'A. Ḥašūrī, (see *Nawrūznāma* C, p. 68): *wa šinūdam az Bāzirkānī ki dar ayyām-i mā būdand ki hič kas az Māhān-i Mih-i Wušmgīr bihtar našinakta andar-i iškira rā ki kār-i išan sāl-i dawāzdah māh šikār kardan būd wa 'Alī-i Kāma ki sipāhsālār-i Badr-i Ḥasanū[ya] būd nīz nikū šināktī walīkan hama muttafiq būdand ki hič kas az Māhān-i Mih bih nadānistī wa ū rā ba-zabān-i kūhī kitāb-i šikaranāma-st buzurg tašnīf-i way. «I have heard from our coeval Bāzirkānī [Kurds] that nobody could say more about falcons than Māhān the Great, the Quail-catcher, since he used to devote himself to hunting twelve months a year. 'Alī son of Kāma, general of Badr, son of Ḥasanw[ayh], was an expert as well, even if everybody still agrees about Māhān the Great's hunting knowledge. He himself wrote in *kūhī* language a voluminous work with the title *The hunting falcon*». A few lines below, (f. 99<sup>a</sup>) the text adds: «It is said that Māhān was a great king, perfect and wise», from where we could infer that Māhān was the name of the famous Quail-catcher. Badr was governor (on behalf of Buwayhid ruler Fannā Ḥusraw) of a wide region, free reign of his father Ḥasanwayh (r. ca. 959-979), leader of the Bāzirkānī (or Bazirīnī) Kurdish tribe. His father played an important role in the military policies of the Azerbaijan and the western regions of the Iranian plateau in the second half of the tenth century. Badr (r. 979-1014) soon regained political independence and he was honoured by the caliph with the *laqab Našir al-Dawla*.*



Persian chronicle *Mujmal al-tawārīk* is described as «extremely Iranian».<sup>13</sup> It was a time of renewed hope for the return of the Iranian people to their ancient splendour. This is well testified by al-Bīrūnī, especially concerning the Buwayhids rulers of Baghdad.<sup>14</sup>

Qābūs has been widely recognized as a refined and well-taught intellectual in Arabic historiographical and biographical works. As Bosworth underlines: «In Qābūs b. Wushmgīr, the dynasty produced an outstanding figure of the florescence of Arabic learning in Ḳurāsān and the East, which his seventeen-year exile in Nīšābūr, while the Būyids occupied his lands, facilitated» (Bosworth 1996, p. 166). Indeed, he was forced to leave his dominions between 981 and 997. That happened because, in 979, Qābūs gave shelter to Faḳr al-Dawla (952 ca.-997), the Buwayhid ruler of Rayy, defeated by his brother Fannā Ḳusraw, best known as ‘Aḏud al-Dawla (r. 949-982), the most powerful representative of the Buwayhid house. In retaliation, Fannā Ḳusraw sent another of his brothers, Mu’ayyid al-Dawla (r. 976-983), to invade the lands of Qābūs, who fled to Nīšābūr, in Ḳurāsān, under the protection of the Samanid ruler Nuḥ II (r. 976-997). He would regain control of his dominions only eighteen years later.

The tower was planned after the prince had perfected his education, that, by the standards of the time, had to include both religious subjects and the «ancient sciences» (*al-‘ulūm al-qadīmiyya*), such as philosophy, medicine, astronomy, mathematics. About this latter, one of the most popular work on the matter between ninth and tenth century was the *Kitāb al-majisṭī*, only partially preserved, by the famous Iranian astronomer Abū ‘l-Wafā’ al-Būzjānī (328-388/940-998).

Abū ‘l-Wafā’ wrote also a treatise on those geometrical constructions which are necessary for a craftsman (*Kitāb fī mā yaḥtājū al-ṣānī’ min al-‘amal al-handasiyya*) for planning and construction of buildings, where he discusses, among other things, how to construct a regular decagon using

13 See *Mujmal al-tawārīk wa ‘l-qīṣaṣ*, p. 389: *Wuṣmgīr az jānib-i Gīlān ba-Rayy āmad wa sakht ‘ajam-ī būd*. This chronicle was written in Seljuk times.

14 In his *Kitāb al-āṭār al-bāqīya* (see *Chronology*, p. 197), al-Bīrūnī reports a *vox populi* in this regard: «People say that the Sasanian rule existed during *fiery* conjunctions. Now, the rule over Dailam was seized by ‘Alī b. Buwaihi called ‘Imād-aldaula during fiery conjunctions. This is what people used to promise each other regarding the restoration of the rule to the Persians, although the doings of the Buwaihi family were not like those of the ancient kings. I do not know why they preferred the Dailamite dynasty, whilst the fact of the transitus into a *fiery Trigonon* is the most evident proof indicative of the Abbaside dynasty, who are a *Khurāsānī*, an eastern dynasty. Besides, both dynasties (Dailamites as well as Abbasides) are alike far from renewing the rule of the Persians and further still from restoring their ancient religion». However, as al-Bīrūnī states in the same work (see *Chronology*, p. 129), those were the times when the imperial title of Sasanian dynasty, *šahinšāh*, was resurrected.

compasses of fixed opening (Bellosta 2002, pp. 507-509).<sup>15</sup> One of his pupils, Abū Naṣr Maṣṣūr ibn ‘Alī ibn ‘Irāq (ca. 950-ca. 1018 to 1036), «who was himself an outstanding scholar and author of some twenty works on mathematics and astronomy, and an outstanding figure in the intellectual history of mediaeval Islam, was the mentor of Abū ‘l-Rayḥān al-Bīrūnī» (Fedorov 2000, p. 71). It is important to observe that al-Bīrūnī dedicated to Qābūs his *Kitāb al-āṭār al-bāqiya ‘an al-qurūn al-kāliya*, written during the period when the Khwarazmian scholar lived under his patronage. He finished this work in 1002 CE ca., just a few years before the building of the tower.

The amīr enjoyed the company and learning of several poets, as well as astronomers and mathematicians, such as Abū ‘Alī Ḥusayn ibn Sīnā, to mention the greatest among them. That is why we believe that the inscriptions on the tower, which proved to be source of obscure dilemmas for van Berchem, can, on the contrary, provide us with a self-evident clue that will drive us towards a correct interpretation of this ‘mysterious’ building.

The novelty of the Arabic inscriptions consists in featuring both an Islamic lunar date (year 397) and an Iranian solar one (year 375; Bartol’d 1966), both of them corresponding to 1006-1007 CE. The solar date clearly pertains to the well known Persian solar era, starting with the official rise to the throne of the last Sasanian sovereign Yazdegard III in 632 CE (16 June) and characterized by a one-day backward shift of all dates of the relative calendar every four years.<sup>16</sup>

In spite of the mobility of this kind of solar calendar and the continuous changing in the correspondence between Yazdgardī dates and fixed seasonal points, a relevant part of the Iranian tradition refers to an ideal coincidence between the first day of the first month of the year (i.e. 1st of Farwardīn) and the 1° of Aries, the first day of spring. The date in the tower inscriptions exactly marks such a coincidence. I have already suggested the possibility of a functional link between that solar date and the purpose of the tower in my introduction to the Festschrift for the 70th Sada of Gianroberto Scarcia (Cristoforetti 2004, pp. 10-12). Now, ten years later, I think it is possible to add some evidence in support of that hypothesis. I will state my case on the basis of considerations that are both general and subsequent to a geometrical and mathematical analysis of the building.

First of all, we must consider the following facts. A well-known feature of the regular decagon is that each of its sides is in *golden ratio* ( $\varphi$ ) to the

---

15 For the Arabic edition of Abū ‘l-Wafā’s work see ‘Alī 1979.

16 Such backward shift is notoriously due to lack - or non-application - of an intercalary mechanism in the Iranian calendar.



radius ( $R$ ) of the circumscribed circumference.<sup>17</sup> This implies that, being the side of our decagon equal to  $AC_1$ , there is a decreasing progression between  $R$  and the segment  $AC_1$  by the meaningful ratio  $(\sqrt{5} - 1) / 2$ . Then, given  $R = M_0 = 1$ , we have  $AC_1 = M_1 = 0.618$ ;  $OC_1 = M_2 = 0.382$  and so on (see fig. 4). That is true for each  $\varphi$  derived segment of the radius. Therefore,  $AG$ , being the segment defining the extroflexion of the flanges of the tower, is the fourth segment ( $M_4$ ) of the above mentioned decreasing progression (see Bulatov 1978, p. 92).

By its geometrical definition the regular decagon is a polygon having all sides of equal length and each angle equal to  $144^\circ$  (fig. 5); therefore, the sum of its ten angles is equal to  $1440^\circ$ . This is of the utmost importance for our understanding of the tower structure, because it implies that the decagon revolution number is 4 ( $1440/360 = 4$ ).

The plan of the tower is derived from the combination of two simple geometrical shapes: the circle and the decagon. The circle is well represented by the circumferences drawing the base and the internal room. The regular decagon is to be perceived by means of ten flanges, whose angles measure  $90^\circ$  each (fig. 5).<sup>18</sup> Then, the elevation of the tower is the vertical development of a star-shaped decagon inscribed in the circumference of the base.

The tower features several solar references. The shape of the Sun is evident in the plan. The external sides of the tower are thirty as the days are in the whole of the months of the Iranian solar calendar current at the time of building. The roof window is not aligned with the entrance (see fig. 1), a fact that is still unexplained: to our knowledge the only attempts made on this regard are mostly based on legendary tales. The window faces east exactly, this fact being a clear clue of its function because it let the window to identify the east-west axis.<sup>19</sup> It is important to notice here that the Arabic inscriptions start precisely from the eastern panels below the window. This combination leads us to consider the functional importance of the east-west axis in the project of the tower. From an astronomical point of view, such axis indicates the exact points of the sunrise and the sunset on two days of the year, that is the days of the equinoxes.

17 In a regular decagon each side subtends an angle of  $36^\circ$  at the centre ( $360^\circ / 10$ ) and a circumference angle of  $18^\circ$ . According to the chord theorem, each side  $s$  ( $AC_2, AC_3, \dots$  in fig. 4) is  $s = 2 R \cdot \sin 18^\circ$ . Given that  $\sin 18^\circ = \sin \pi / 20 = (1 + \sqrt{5}) / 4$ , then,  $s = R \cdot (1 + \sqrt{5}) / 2$ , i.e. the side  $s$  is in *golden ratio* to the radius  $R$  of the circumscribed circumference.

18 This specification is most due to the fact that, according to the plan of the building traced out by Diez (1918, p. 39) and uncritically reprinted in the *Encyclopædia Iranica* (Blair 2003, p. 129, fig. 1), the angles of the flanges measure  $72^\circ$  each; Also Bulatov accepted the same wrong measure (1978, p. 90, fig. 25).

19 It should be noticed that the road axis of nearby ancient Jurjān was oriented in the same way.

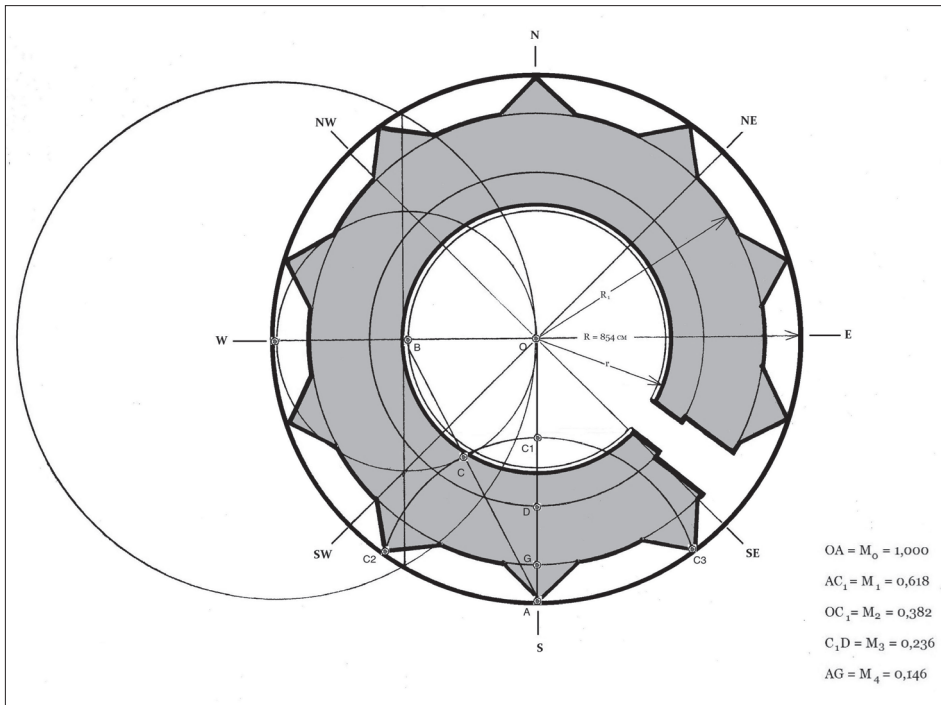

Figure 4. Oriented plan of the Gonbad-e Kāvus tower with indication of the parts ( $M_0, M_1 \dots$ ), given  $R = 1$

Of course, the geometrical evidence I brought up until now is not enough: the features of regular decagons, with their angular sum of  $1440^\circ$ , and the lasting of the Iranian Great Year measuring 1440 year, could be a mere coincidence. However, I got quite confident to support a calendrical interpretation of the plan only after considering the discrepancy between the window and the inscriptions on one side and the entrance on the other. This is highly unlikely to be merely casual,<sup>20</sup> the more so when we consider that the architect shifted the entrance on a different side of the tower than the window and inscriptions, managing to create two internal angles of  $36^\circ$  (E angle) and  $144^\circ$  (W angle) between the focus of the entrance and the east-west axis (fig. 5). This is obvious to any attentive observer, with no need for advanced knowledge of geometry; it is enough to count the

20 A further, even though not needed, confirmation of this, can be found in the miniature of the tower of Gunbad-i Kāvus located in the garden of the Iranian Art Museum (Tehran), where window and entrance are in line, thus unwillingly ‘correcting’ the ‘asymmetry’ of the original tower.

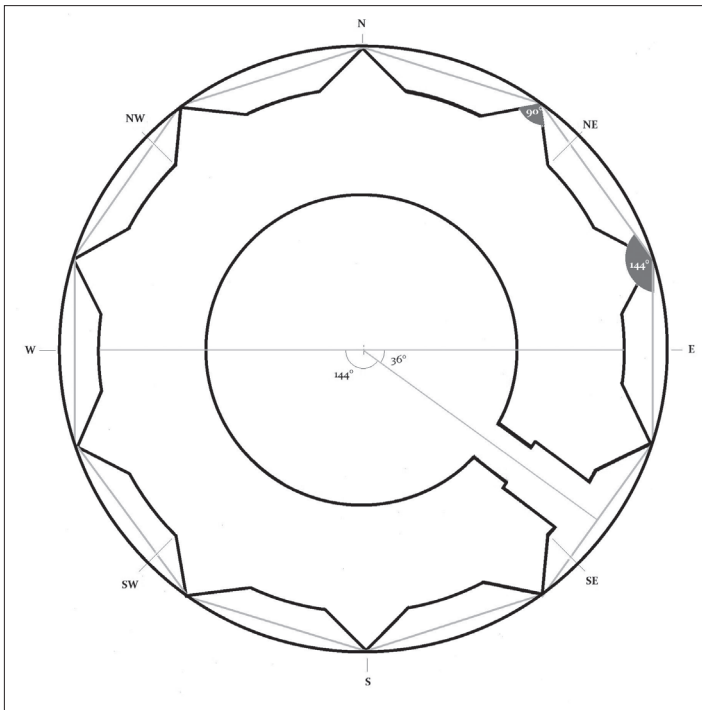

Figure 5. The regular decagon defining the star-shape plan of the Gonbad-e Kāvus tower

facades between the flanges: the entrance focus is placed at  $1/10$  of the circumference from the east radius and  $4/10$  from the western one. These are self evident measures. The only reason for this choice can be a precise will to place the entrance at  $144^\circ$  and  $36^\circ$  in a decagon shaped building oriented on east-west axis.<sup>21</sup> But why?

As already stated, each perimetric angle of the regular decagon measures  $144^\circ$ , summing up to  $1440^\circ$ , and all the vertex angles of the triangles formed with its sides as bases measure  $36^\circ$ . Needless to say, between  $1440$  and  $360$  and between  $144$  and  $36$  the ratio is the same, that is  $4$ . The deliberate discrepancy quite harmonically points to the decagon revolution number ( $4$ ). This is the number expressing the backward moving of the

<sup>21</sup> The focus of the entrance does not have a meaningful orientation in regard to the cardinal points. Other meaningful points of entrance do not create internal angles with the coordinates of the building recalling the *golden ratio* of the structure. It should be noted that, observing the entrance from outside the building, the left edge is exactly SE from the centre of the tower (fig. 5).

Iranian year through the seasons (that is one day every four years). In addition, it does not seem far-fetched at all to say that the tower of Qābūs bears a reference to the so-called intercalary cycle (*dawr al-kabīsa*) of the Iranian calendar lasting 1440 years.<sup>22</sup> Indeed, though it is mathematically true that a solar year of 365.25<sup>d</sup>, according to the average measure of the solar year considered at that time, entails a backward cycle through the solar seasons of exactly 1461 solar vague years (= 1460 solar Julian years),<sup>23</sup> we should keep in mind that coeval astronomical tradition – well attested in the works by Bīrūnī and Kūšyār ibn Labbān al-Jīlī – believed in the existence of an intercalary mechanism of the Iranian calendar, working in ancient (Sasanian) times in order to maintain the New Year Day (*nawrūz*) in acceptable correspondence with the beginning of the spring, and abandoned after the Muslim conquest. The Iranian intercalation (*kabīsa*) was believed to function by the insertion of an extra month every 120 years, marked by the shift of the five epagomenal days (*kamsa*

22 Explicit mentions of the intercalary cycle (*dawr al-kabīsa*) of the Iranian calendar lasting 1440 years are in *Muntahā al-idrāk fī taqāsīm al-aflāk* (MS Or. 110 of the Biblioteca Medicea Laurenziana in Florence: ff. 92<sup>b</sup>-93<sup>a</sup>) by ‘Abd al-Jabbār b. Muḥammad al-Ṭābitī al-Kharaqī (d. ca. 500/1106-7), and *al-Tuḥfat al-shāhiyya fī-’l-hay’a* (London, BL, MS Add. 23393, ff. 151<sup>b</sup>-152<sup>a</sup>; Paris, BN, Fond Arabe 2516, f. 98<sup>b</sup>) by Quṭb al-Dīn Maḥmūd al-Shīrāzī (d. between 710/1310 and 716/1316). I believe that other possible evidence of the Iranian 1440-yearly cycle could be found in the *Dastūr al-’amal wa taṣḥīḥ al-jadwal*, the commentary to Uluḡ Bīg’s *Zīj* written in 904 (1498-1499) by the Ottoman astronomer and mathematician Mīrīm Çelebī (d. 931/1525), grandson of the teacher of Uluḡ Bīg. Şalāḥ al-Dīn Mūsā ibn Muḥammad ibn Maḥmūd Qāḏizāda al-Rūmī (see Taqizadeh 1937-1938, p. 170 n. 335; Italian ed.: p. 298). As it was customary for any astronomer writing after the reform introduced by Malīkšāh al-Saljūqī in 1076-1079, Mīrīm Çelebī comments the intercalary cycle of the Jalalian calendar, that entails 4- and 5-year periods for the leap years. To find the order and alternation of the 5- and 4-year intercalary periods requires the harmonisation of the length of the solar tropical year with the length of the calendrical solar year (an exercise fit for a consummate astronomer only!). Unlike several other astronomers, who elaborated intercalary cycles of 220, 268, and 300 years, Çelebī elaborated a much longer cycle lasting 1440 years, with 349 leap years. Taqizadeh notes: «It is unknown why Çelebī assumed as a basis for his measure of the fraction of the solar year the astronomical observations from the *Zīj-i ilkānī*, disregarding the observations from Samarqand, even though he himself did comment the *Zīj-i ilkānī* by Uluḡ Bīg, and his grandfather collaborated with that sovereign» (Taqizadeh 1937-1938, p. 173 n. 335; Italian ed.: p. 301). In my opinion all of this is a clue of how the idea of a 1440-year cycle connected to the Iranian calendar may have influenced the Ottoman scholar.

23 The *Nawrūznāma* speaks *apertis verbis* of a «Great Cycle» (*dawr-i buzurg*) lasting 1461 years (MS Add. 23568, f. 86<sup>b</sup> BM London; the two passages are full of lacunae in MS Cod. Or. 8° nr. 2450, ff. 78<sup>b</sup> and 79<sup>b</sup> SB Berlin): «The *nawrūz* was instituted because the Sun has two cycles, the first fixed by his return to the 1° of Aries every 365 and ¼ days – that time is called *nawrūz* and *nawsāl* – and the other fixed by his return every 1461 years to the same degree at the very same moment and day when it started to move [...]. Then [Gayūmart] subdivided the great cycle into four parts, every part of 365 and ¼ years, just as, we know it by reason, the year lasts 365 and ¼ days, and called it Great Year. Each time the four parts of this Great Year pass away, it is the Great Nawrūz and the renovation of the world». Then, according to this text, the Great Cycle lasts 1461 years ( $365.25 \cdot 4 = 1461$ ).

*al-mustaraqqa*) from the end of a given month to the end of the next month. Then, mathematically we have  $\{12 \cdot [(365 \cdot 120) + 30]\} / 365.25 = 1440$  years, that is the amount of years taken for the five epagomenal days to regain their ideal position at the end of the year (after the twelfth month of Isfandārmaḍ), immediately before the spring equinox and the New Year Day.<sup>24</sup> The aforementioned cycles are two: that of the backward motion of Nawrūz during 1461 years, if we assume that the calendar was not intercalated, and that lasting 1440 years characterized by the 120-yearly shift of the epagomenal days from month to month, if we assume that the calendar was indeed intercalated. In both cases, these cycles have their pivotal point in the momentous return of the New Year Day (*nawrūz*) to its ideal position on the spring equinox in the first day of the first month (Farwardīn) of the Iranian calendar. That moment was felt as the proper and 'right' seat of Nawrūz. The closing and simultaneous beginning of a new calendrical cycle, marked by the dates mentioned in the inscriptions encircling the tower, well explain the shift of the five epagomenal days from their traditional position (in Islamic times) after the eighth month to the end of the year - shift that occurred at the beginning of the eleventh century CE. This is a pivotal question, as will be shown later.

At Qābūs' time, the approximation of the tropic solar year to 365.25<sup>d</sup> (the same one determining the 4-year intercalary cycle in the Julian calendar) was well-known. It was normally used in calendrical sections of astronomical works to ease calculations for converting dates from one calendar to another.<sup>25</sup> That was a basilar notion for any astronomer, who needed to convert cycles of different lengths, as the solar or lunar year, to the same reference system, i.e. the 360° circumference. Their work aimed to convert dates of the year (day, hour, minute etc.) into degrees of Zodiacal months, each equal to 30°, sometimes operating the same conversion the way back. The link between the geometrical refinement of the tower and its astronomical connection to the solar year is nothing less

<sup>24</sup> This idea is frequently maintained in Arabic and Persian sources; according to François de Blois (1996, p. 50), it may have appeared in the Iranian milieu of the astronomical studies of the first Islamic age. On this matter see also Panaino 1996, pp. 298-301; 2010, p. 161; 2014, p. 87 n. 2, and p. 93. At any rate, it should be noted that ancient authors do not discuss the loss of 60 days that occur over an entire intercalary cycle and which is due to the shift of the *andargāh* from a month to the next month; in order to avoid such a loss of 60 days during the intercalary operations, it would be necessary not to shift the *andargāh*, but keep it in its position and insert another *andargāh* (relative to the following intercalary turn) after the first month on the first intercalation, after the second month on the second intercalation (120 years after) and so on.

<sup>25</sup> Al-Bīrūnī justifies the use of this approximated measure of solar tropic year in his *al-Qānūn al-mas'ūdī* (written in 1030), stating that, in the end, «it would not cause a divergence bigger than 1/10 days»; according to the great astronomer, in the case of the solar year, 1° is equal to 1 day + 7 / 480 day, i.e. 1<sup>d</sup> 0<sup>h</sup> 21<sup>m</sup>; see *al-Qānūn*, p. 130.

than evident if we consider the fact that it exists a mathematical ratio  $1/10$  between the segment  $M_4$  (posed  $R = 1$ )<sup>26</sup> and the average daily increase in  $1^\circ$  (calculated on the basis of an average solar revolution of  $365.25^d$ ).<sup>27</sup> Then,  $M_4$  plays a pivotal role in the project, as it directly relates the geometrical development of the building to its astronomical meaning. On the matter, it should be noticed that  $M_4$  is the measure of the extroflexion of each one of the ten flanges.

The arched entrance is 162 cm wide on the outside and 132 cm wide inside (measures given by Bulatov 1978, p. 90, fig. 25. Noci 2008, p. 840, gives 160 and 132 cm respectively), because there is a bottleneck in the entrance marked by vertical slips (fig. 6). The arch of entrance is everted in his upper part, creating small steps. Apart from the inscriptions, the only other decoration is placed on both sides over the vertical slips. This decoration is formed by two trilobated niches in stucco (Schroeder 1939, p. 1003, fig. 344). The vertical slips are structural elements of great importance. They clarify the function of the tower as a solar watch, explaining why the entrance is not aligned to east-west axis. In fact, on the equinox days, at sunrise, the north-east corner of the entrance projects its shadow exactly into the south-west vertical slip in the entrance (fig. 7). On 23

26 The idea of associating numbers to an arbitrary measure (see fig. 4, where  $R = 1 = M_0$ ) was all but new at the beginning of the eleventh century (cf. Ben Miled 2002, p. 353). On a practical level, this allows to mathematically derive, in an easy and precise way, all the measures of the geometrical elements composing the project: in our case it suffices to multiply a part ( $M_0, M_1, \dots$ ) by the measure of length attributed to the radius ( $R$ ). The measures of length can thus be calculated in relation to different systems of measure. It should be noted, on this regard, that the *gaz* could be subdivided in 120 *fuls* or in 24 *angušt*; see *sub voce gaz* in Dihkudā 1957, p. 280. So operating, having a measure of  $R_1$  equal to  $R - M_4$  ( $1 - 0.146 = 0.854$ ), given  $R = 9$  *gaz-i šāhī*, the measure of  $R_1$  is equal to  $0.854 \cdot 9 = 7.686$  *gaz-i šāhī*, that is  $0.854 \cdot (9 \cdot 120) = 922.32$  *fuls*; that is  $0.854 \cdot (9 \cdot 24) = 184.464$  *angušt*. When adopting the decagon as the shape of choice, it is not surprising that all of the harmonic parts in the plan ( $M_0, M_1, \dots$ ) are expressed by irrational numbers. For example, even in the half of the 9th century, the famous algebraist ‘Abū ‘Abdallāh Muḥammad ibn ‘Īsā al-Māhānī (who worked in ‘Irāq around 860 ca., d. 880) analysed irrational numbers in his commentary to the 10th Book of Euclid’s *Elements* (*Tafsīr al-maqāla al-‘āšira min kitāb Uqlīdis*), calling them «mute quantities» (i.e., non-expressible, if not by radicals; the first edition of this work, along with an analysis of the text and a French translation, is available in Ben Miled 1999). For a practical solution to the problem of transferring in measures of actual length those measures expressed by radicals, Bulatov (1978, p. 124) demonstrates that to define the equivalent of  $\sqrt{3}$  ( $= 1.732\dots$ ), one preferred to approximate to 1.75 over 1.73. As for the measure of the extroflexion of the flanges in the tower of Gonbad-e Kāvus ( $AG = M_4$ ) Bulatov (1978, p. 92) finds an approximation of -2.6 cm, resulting from the calculus ( $0.146 \cdot 854 = 124.6$ ). In my opinion this case shows a down rounding to  $1 + 18/60$  *gaz*. Indeed, given  $R = 9$  *gaz-i šāhī*, we obtain a measure of the *gaz-i šāhī* equal to 94.8 cm, that is an intermediate measure between those proposed by Fryer and Chardin, which are 94.745 cm and 95.15 cm respectively; see Hinz 1955, p. 62.

27 On the basis of al-Bīrūnī’s statement (*al-Qānūn al-mas‘ūdī*, p. 130),  $1^\circ = 365.25^d / 360^\circ = 1.014583 \approx 1.0146^d$ , i.e.  $1^d 0^h 21.024^m$ . Consequently, the average daily increase in  $1^\circ$  is equal to  $0.0146^d$ , and this measure is equal to  $1/10 M_4$ .

September 2014 I was able to ascertain the phenomenon *de visu*, thanks to the kind collaboration of the superintendent of the Research Center for Iranian Cultural Heritage in Gonbad-e Kāvus, Dr. Jebrael Nokandeh, and the Iranian scholar Dr. Farid Ghassemlou.<sup>28</sup> This fact clearly shows the functional usage of the building as a solar watch indicating the seasonal points. In fact, that day at sunrise the shadow of the north-east corner of the entrance moves inwards reaching its extreme internal projection in the winter solstice day. Later it moves backwards and returns into the south-west vertical slip in the entrance on the vernal equinox. Then, the shadow moves outwards along the wall day by day to reach its extreme external projection on the summer solstice. One could even dare to assume that the tower was meant to function as the gnomon of a solar watch. Regrettably, to my knowledge, a study on this subject is still to be done.

The absence of a fully developed study on this matter notwithstanding, we can assume that to the trained eye of a geometer, of an astronomer, or of a person gifted with geometrical-mathematical sensitivity and with a sound sense of proportions – as it is the case of a refined calligrapher – the features of this building clearly indicate the flowing of time, marked by its traditional calendrical subdivisions. The ‘Great Year’ is evoked by the 1440° of the decagon, the solar year by the moving of the shadow of the north-east corner of the entrance at sunrise, and the solar month of the Iranian calendar of that time by the thirty sides of the building. Such a refined scholar, not unlike the common visitor, will indulge in strolling around the tower, following the inscription that runs all around it. He will proceed from the east, just as the Sun does, setting in motion the mechanism of the Iranian Time embodied by the tower of Qābūs. He will meet the end of the circle going past the vertices of ten flanges, implicitly tracing two shapes out: the fundamental circle and the decagon, geometrically combined to create the harmonic measures structuring and raising the building.

Last but not least, the tower has another fundamental and typical Islamic feature, unnoticed till now. Since solar rays penetrate directly into the building at floor level only in some of the morning hours between the end of autumn and the beginning of winter, the entrance walls project a fixed shadow on the internal floor. This fixed shadow reaches a point of the internal circumference located at south-west from the centre of the building. On the spot given by the geographic coordinates of Gonbad-e Kāvus, the *qibla* direction is south-west (fig. 8).<sup>29</sup>

In my opinion, considering all of these elements as a whole is the only way to adequately comprehend the building – its celebrative function of

28 In Gonbad-e Kāvus the autumnal equinox was 23 September 2014 at 4:59 am (local time), the sunrise being at 5:41 am (local time).

29 The *qibla* direction for Gonbad-e Kāvus is 224° 27' from the true north.





Figure 6. Arched entrance of the tower of Gonbad-e Kāvus with one of the two stucco niches

a truly meaningful calendrical cycle for Iranian sensitivity and its close relation to an astronomical phenomenon of the utmost importance as the apparent motion of the Sun in its various expressions. The ruler aimed at celebrating the end and renewal of the great cycle of the Iranian year (a sort of Jubilee of Gayūmarṭ and Jamšīd, so to say), and, for the future, marking the clear relation between the traditional solar calendar and the vernal equinox – taking for granted the immutability of the calendar, of course. Sure enough, the tower was meant to function as a solar date setter, allowing an accurate determination of the date of the opening of the fiscal year and a basis for fixing payment deadlines for land taxes.

It seems to me that the building quite satisfies three needs at least, justifying such an enterprise: a need for dynastical propaganda (Qābūs as the ruler of the New Age just as a new Gayūmarṭ and a new Jamšīd), an administrative need in a fiscal equality perspective, aligned to the most ancient tradition (Qābūs as a new Anūšīrwān-i ‘ādil, the dispenser of justice, that is the dispenser of the right measures, as the ancient king Jamshīd



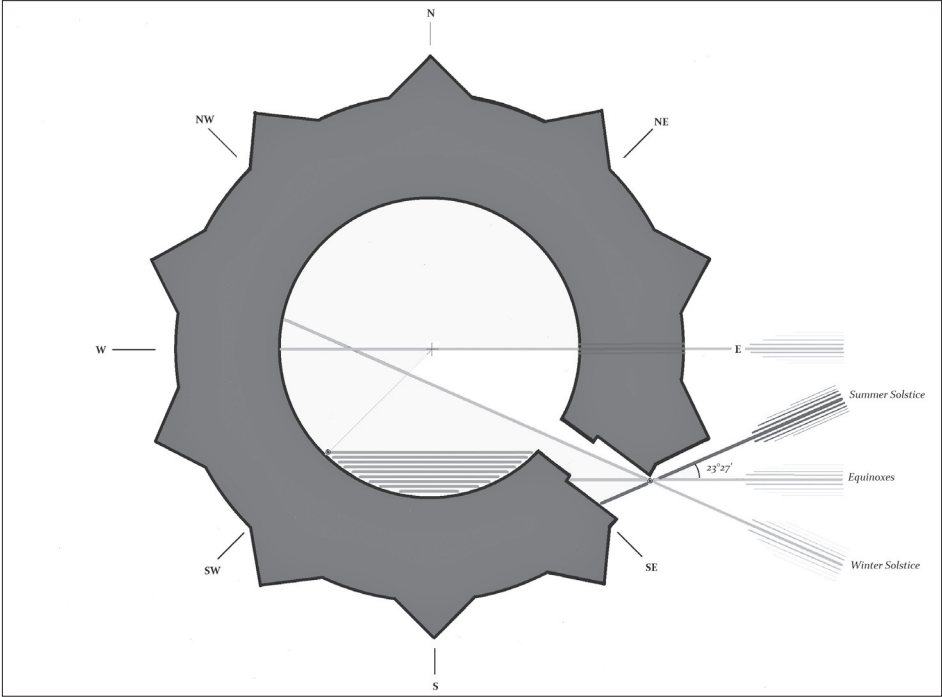

Figure 7. Projection of the sunbeams at sunrise at equinoxes and solstices through the entrance of the Gonbad-e Kāvus tower

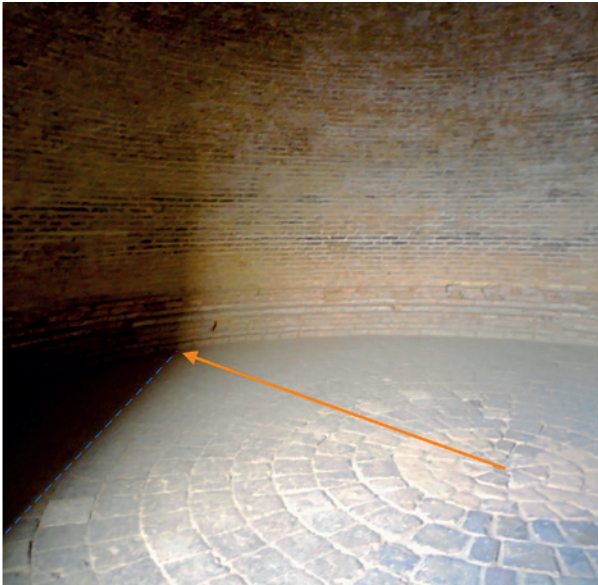

Figure 8. Floor level inside the tower: the arrow in the figure indicates the qibla direction and the dashed line shows the fix shadow of the entrance walls

did at *nawrūz*),<sup>30</sup> and an Islamic orthodox need (Qābūs as the ruler seeing to the accuracy of the daily prayer). Of course other possible functions are not to be excluded, such as to point out the way to travellers, as it has been often suggested.

One could easily argue that, admitting such purposes for the building of the tower, we may find difficult to explain why the Arabic inscriptions do not bear any clear reference to those, restraining the matter to the allusive domain of geometry. In short: why don't the inscriptions cry out loud what the tower whispers as a whole?

Apart from the fact that allusiveness is the main mark of the whole of Persian aesthetical production, I think that the chosen means of communication were very much respondent to the political and cultural climate of the time. Could an open statement of continuity with the ancient Iranian kings' traditions be interpreted and blamed as a prelude to a come-back of the religion of the Magi?

This danger was real, as well shown by the *vox populi* reported by al-Bīrūnī about the Buwahids, and was to be avoided even more in relation to the firm Sunnite politics of that dynasty and of Qābūs himself in particular.<sup>31</sup> Moreover, the wide diffusion of Avicenna's neoplatonised Aristotelianism and of a scientific thought that never failed to seek close relations between different levels of reality, in esoteric terms too – as the coeval production of the encyclopaedic work entitled *Rasā'il iḳwān al-ṣafā'* well testifies – can help in understanding how allusiveness was one of the several ways of communication and expression used at the time.

The politics of equilibrium between traditional heritage and institutional Islamic demands carried out by the Ziyarid prince is well recognizable in an anecdote about him to be found in the *Nawrūznāma* (A, pp. 32-33.) The passage goes as follows: Qābūs is requested to judge the damage inflicted on a field of barley by a stallion in springtime; his position is complicated by need to mediate between law – requiring a full amend for the damage caused by the horse – and tradition – requiring to let the stallions pasture

---

30 See al-Bīrūnī, *Chronology of Ancient Nations*, p. 203: «On the same day (i.e. *nawrūz*) Jam brought forward all kinds of measures; therefore, the kings considered his way of counting as of good omen».

31 In the *Nawrūznāma* Qābūs is showed as a very pious Muslim possessing a deep knowledge of the *Quran*. As a matter of facts (*Nawrūznāma* A, p. 48) this work contains an anecdote on a historical episode. The passage tells us about the epistolary exchange between 'Aḍud al-Dawla and his rebel brother Faḳr al-Dawla, who, having just received answer from his brother, showed the letter to Qābūs. The words of 'Aḍud al-Dawla saddened Qābūs, who lamented their shared misfortune by writing below 'Aḍud's epistle a gloss (preserved in the Arabic version of the text): *qad aflaḥa man tazakkā wa qad kāba man kaḍḍaba wa tawallā*. That gloss was skilfully composed by combining phrases that occur several times in the *Quran*; just to cite a couple of examples, the first half can be found in *Quran* 87,14 and the second in *Quran* 96,13.

on new barley at *nawrūz*. Needless to say the prince judged fairly, imposing the amend, but exhorting the land owner to a greater flexibility towards horse-breeding traditions.

The conclusions that follow the analysis I just laid out directly involve an important question concerning the history of the Iranian calendar<sup>32</sup> and it is necessary to briefly linger over them.

The renewed, epochal synchronisms between the *nawrūz* of 1st of *farwardīn* of the solar vague calendar and its ideal position at the 1° of Aries occurred after more than one thousand years and had happened together with another phenomenon related to the structure of the calendar hereby in question. I am referring to the already mentioned shift of the five epagomenal days from the end of the eighth month – that is their position as was set in the late Sasanian age and where they stayed during the first Islamic age – to the end of the year, after the twelfth month. This moment, from an Iranian perspective, signs the return to a condition of ideal primeval order. The oldest mention on this matter is a rather short text from the *Zīj al-jāmi‘*, written in Arabic in the second half of the fourth century of Hegira (beginning of eleventh century CE) by Iranian astronomer Kūšyār ibn Labbān al-Jīlī.<sup>33</sup> This text lacks any reference to the responsible for the shifting:

In the time of Kistrā ibn Qubād Anūšīrwān the Sun entered Aries in *āḡar-māh* [ninth month] and the five [epagomenal] days seated at the end of *ābān* [eighth month]. When, one hundred and twenty years later, the dynasty of the Persians fell and they got subdued by the Arabs, [...] the five [epagomenal] days stayed at the end of *ābān-māh* [eighth month], till the year three hundred and seventy five<sup>34</sup> of the Yazdajird era, when the Sun entered Aries on the first day of *farwardīn-māh* [first month]

**32** I prefer to call it Iranian calendar rather than Zoroastrian calendar, as it is customary in the scholarly tradition, because the latter definition seems to me to be reductive of an historical phenomenon of such a great socio-cultural relevance, and also because it is a better match for the definitions found in the sole ancient sources that speak extensively about it, i.e. the astronomical works of the Islamic age. In those texts the expression adopted is usually «the calendar of the Persians» rather than «of the Magi», even though Persian Magi did use that same calendar and this fact was well known.

**33** This work was probably finished in 389 H (1020-1021 CE; Bagheri 2008, p. 69). A complete edition is still lacking. For some important considerations – substantially different from those given by Bagheri – on the dating of this work, see de Blois 1996, p. 52 n. 37 and n. 38.

**34** There is complete correspondence between this date and the solar date in the tower's inscriptions. In chronological tables this year corresponds to the third year of a 4-year period in the Julian calendar (1004-1007); see Mayr/Spuler 1961, p. 38. The astronomers in their calendrical calculations referred to 4-year periods, indicating the backward shift of the *nawrūz*. It is possible that those periods were 'out of phase' by two years from the intercalary periods in the Julian calendar; were such the case, the first year of reign of Yazdgard III would be the third of a 4-year period of that type. On the matter see Cristoforetti 2014.

and the five days were placed at the end of *isfandārmaḡ-māh* [twelfth month].<sup>35</sup>

If, on the one hand, the text does not allow us to assume a one-man venture, it does not fail, on the other, to testify a remarkable sensitivity to the matter. Several scholars tried to identify the mind behind this operation as one of the many prominent political men of that time: first, the hypothesis of Hasan Taqizadeh, who favoured Bahā' al-Dawla – likely, but not certainly, in virtue of his military and political prominence of the Buwayhid (Taqizadeh 1937-1939, pp. 917-918); secondly, the deliberate and completely unexplained assumption of Ḍabīḡ Bihrūz, pointing to the Saffarid Khalaf ibn Aḡmad (Bihrūz 1952-1953, p. 56); lastly, we can mention S.J. Bulsara, who saw in Qābūs ibn Wušmḡir the eluding policy-maker, but his position is flawed by too generic arguments, focusing on alleged Qābūs' Sasanian ancestry (Bulsara 1953, p. 191).<sup>36</sup> The scholar states: «It was not improbable that the Zarathushtrian intercalation was implemented under the patronage of the great Iranian monarch Kabus Vashmḡir [*sic*] of Tabaristan, as his house was a branch of the imperial house of Sassan and had apparently preserved Zarathushtrian practice in a very great measure». By «Zarathushtrian intercalation» we should understand the simple shift of the five epagomenal days from the end of the eighth month to the end of the year.<sup>37</sup> I see no reason why Zoroastrian practices need to be alive to let a Muslim ruler regulate the calendar in use in his dominions and current among their rural population for administrative purposes.

A much relevant, coeval (dated 1008-1009 CE), Zoroastrian source is the first of three questions asked by some Khurasanian Zoroastrians to a chief priest, which immediately follow the *Riwāyat* of Āḡurfarrāh-i Farruḡzādān in the MS TD2 edited and printed in Bombay (K.L. Bhargava & Co., 1969) by Behramgore Tehmurasp Anklesaria (de Blois 2003, p. 139). It identifies a government official named 'bwmswl as one of the persons responsible for the shift. The editor of the text, B.T. Anklesaria, emends the name to

35 This work is still unpublished. I translate this passage from the German translation available in Ideler 1825-1826, p. 547 and p. 625. Another reference to the shift of the epagomenal days is to be found in al-Bīrūnī's *al-Qānūn al-mas'ūdī*, p. 129.

36 See also Bulsara 1953, p. 188 n. 3: «This era [i.e. 1006 AD] was remarkable for revival of Iranism in Iran and surrounding areas. Shah Kavous Vashmḡir [*sic*] (976-1012 AD), the patron of the celebrated writer Al-Biruni, was the ruler in Tabaristan, and belonged to a branch of the Sasanian imperial house; and it was not improbable that the above intercalation was made under his direction and patronage».

37 I fully agree with what de Blois says about the term *wihēzag*: «a word which is sometimes used for the intercalations allegedly carried out by the ancient Persian kings, but which also means simply 'moving'» (de Blois 2003, p. 139). On the question of the Iranian calendar see de Blois 1996; on the meaning of *kabīsa* – too many times translated as «intercalation» with excessive ease – as resulting from the sources, see Cristoforetti 2009.

Abū Maṣṣūr. This reading is followed by J. de Menasce, who, keeping in mind that the text speaks of this person as a government official, states that he «was obviously a Muslim» (de Menasce 1975, p. 553).

As shown by François de Blois – who identifies the man as «a Zoroastrian in the service of the Muslim government» –, the full name found in the text has to be read Abū Miswar Yazdān-paδ son of Marzbān. In his article the scholar completes the discussion of the accounts on the shift of the five epagomenal days given by two Muslim astronomers, Kūšyār ibn Labbān al-Jīlī and Abū 'l-Rayḥān al-Bīrūnī (see de Blois 1996), and concludes: «The letter indicates that it [i.e. the reform] was instituted by the *mōbaδ* (who evidently resided in Fārs), that the *mōbaδ*'s instructions were communicated to the believers in Khurasan by a Zoroastrian dignitary residing in Baghdad, evidently a middle-ranking official in the service of the Buyids, and that some of the 'Magians of Khurasan' did indeed reject the reform» (2003, p. 143). In his study, de Blois focuses very much on the climate of the time regarding the problems of the Iranian calendar. Indeed, as he concludes, «the difference between the Muslim astronomers and the Zoroastrian author of the questions is that the former describe this as essentially a matter of calendrical calculations, while the latter is concerned mainly with the correct performance of the ritual». However, Zoroastrian priests and Muslim astronomers were not the only ones who were keen on the subject. If, reading the Zoroastrian text according to de Blois, it is to understand that the reform «was initiated by the *mōbaδ* himself and was not 'enforced' by Muslim officials» (p. 140), I can add that it is far from being deniable that Muslim rulers too may have operated on their own administrative calendar, that was just the same in use among the Zoroastrians.

Surely, for Muslim rulers, connecting the date of the opening of the fiscal year directly to *nawrūz* held the greatest importance, as shown by sources regarding the several reforms of the Iranian calendar implemented by Muslim rulers of Iranian origins for fiscal purposes in the second half of the tenth century. Among them we must mention the reform of 959 by the *ḳwārazmšāh* Abū Sa'īd of the line of Banū 'Irāq<sup>38</sup> in Transoxiana, the reform of 984 under the vizierate of Ismā'īl ibn 'Abbād in the lands under Buwayhid suzerainty and that of uncertain dating performed by the Saffarid ruler Ḳalaf ibn Aḥmad (r. 352-393/963-1001-2) in Sīstān (see Cristoforetti 2003, pp. 141-156). All these reforms related on various levels to the opening date of the fiscal year, i.e. *nawrūz*. Such adjustments could

38 The first cousin of Abū Sa'īd Aḥmad ibn Muḥammad ibn 'Irāq (not later than 952-not earlier than 977) was Abū Naṣr Maṣṣūr ibn 'Alī ibn 'Irāq, the aforementioned mentor of al-Bīrūnī.

be brought out by different means;<sup>39</sup> anyway, they had well known models in similar reforms ordered by the Abbasid caliphs.<sup>40</sup>

All these measures point to a true reformer tradition, either through a forced modification of the calendars structure or a shift of a meaningful date. In about seventy years after the building of the tower of Gunbad-e Kāvus, this trend of calendrical management was fulfilled by the famous reform of Malikšāh, who took the Iranian calendar to its ideal structure, the very same it had at the time of Qābūs, ‘freezing’ it by inserting the Jalalian intercalary mechanism. Hence the calendar of Malikšāh, needless to say, became a solar fixed one, ceasing to be vague, and featuring its five epagomenal days after the twelfth month. That means that – in a calendar where *nawrūz* coincides with the vernal equinox (that is the case at the time of Qābūs) – it was obvious and natural that the five epagomenal days were to be found in that position, at the end of the year. As demonstrated by de Blois in his study, this fact met opposition in the Zoroastrian side alone, due to the strong conservatism of some among them in liturgical matters.

I am confident to say that my interpretation of the tower is relevant to this subject. We can assume that the building is a representation of the solar cycle of the Iranian calendar, otherwise we should revert ourselves to seek an ever-eluding grave. Qābūs planned a building whose elements refer to a 1440-yearly cycle. This fact implies that at the moment of the epochal return of the 1st *farwardīn*, or *nawrūz*, to the 1° of Aries, the five epagomenal days were to be counted at the end of the year and not at the end of one of the precedent months. This is true because a 1440-yearly cycle can be considered *only* implying that the shift of the five epagomenal days was a connatural mechanism to the Iranian calendar. The Arabic sources do not give us a name to be held responsible for this shift, as if such operation were only *natural* in that calendrical system, and not to be attributed to any official or ruler. Moreover, the orientation of the entrance of the building allows to individuate the equinoxes and, subsequently, to know when to operate the shift of the five days, if needed.<sup>41</sup>

39 It could be the stabilization of the *nawrūz* on a fixed seasonal position, or the shift of the *nawrūz* from the start of the month of *farwardīn* to the start of another month of the Iranian calendar; both with or without the adoption of the Julian intercalary system.

40 We have knowledge of attempts to reform the Iranian solar calendar by al-Ma'mūn, al-Mutawakkil, al-Mu'taḍid et al.; see Cristoforetti 2003, pp. 122-140.

41 Sources from the Islamic age and popular festive customs testify of this. On this regard there is a passage of extreme clarity in the discourse on chronology in the *Muntahā al-idrāk fī taqāsīm al-aflāk* by Abū Bakr Muḥammad ibn Aḥmad al-Ṭābitī al-Ḳaraḳī. Concerning the year 500 Yazdgardī (beginning 12 February 1131, ending 11 February 1132), the author writes: «The Saturday, 12th of the month of *rabī* the 2nd in the year [52]5, the year 500 in the era of Yazdajird, the turn of the *kabīsa* returned to the month of *urdībīhišt* and therefore we held *kabīsa* in the month of *farwardīn*, and we added the five epagomenal days to its last

As I already observed, the most evident elements of the Arabic inscriptions of the tower of Qābūs are the year of the building – that is, up until today, the most important date of the Iranian *Heidentum* retained through the Islamic era – and the name of its magnificent patron. In other words the tower of Qābūs is an architectural evidence of the Iranian calendrical sensitivity of that time – the time of the momentous return of the *nawrūz* on the vernal equinox and the renewal of the Great Year of the Persians, holding relevant meanings at symbolical and propagandistic level.<sup>42</sup> Oddly enough, a century of scholarly research on the possible astronomical and/or astrological meanings of the building, has not taken into account such a clear indication.

There is no doubt that the time expressed and measured through the structure of the tower of Gunbad-e Kāvus is the Time of the Iranian heritage, embodied by the building both in its solar yearly cycle and calendrical 1440-year cycle. The tower is a ‘jewel’ of a Grand Watch representing, and therefore cyclically defining, the solar time in the Iranian world.

To interpret this building from perspectives that are different from the standard esthetical and architectural ones, opens new ways of analysis, aiming to the development of categories of thought that go beyond the scholarly tradition of pure technical and architectural description. Further research may find more examples of building in need of a broader approach, but a case as strong as the one just presented here is nonetheless sufficient.

days and so its days numbered thirty-five» (MS Or. 110 of the Biblioteca Medicea Laurenziana in Florence: f. 93<sup>b</sup>). I discussed this passage and other material on the matter of the shift of the five epagomenal days in the Iranian calendar in Cristoforetti 2007, pp. 47-54.

**42** As far as other possible symbolic and propagandistic levels are concerned, it is noteworthy that the date of construction of the tower matches the ‘middle conjunction’ of Jupiter and Saturn indicating the passage from the fire to the earthly triplicity (that conjunction started in Leo and ended in Virgin). The astrology of conjunctions believes those moments to be important for the change of dynasties (the previous middle conjunction, in 749 CE, signed the upcoming of the Abbasid dynasty; see *Chronology*, p. 197). However, this coincidence of dates is the only evidence in this direction that I found and no other element was found to relate the geometry of the building with this astronomical phenomenon.



## Bibliography

### Primary sources

- al-Bīrūnī (Abū 'l-Rayḥān Muḥammad ibn Aḥmad al-Bīrūnī) (1879). *Chronology of Ancient Nations*. Trans. by C.E. Sachau. London: W.H. Allen & Co.
- al-Bīrūnī (Abū 'l-Rayḥān Muḥammad ibn Aḥmad al-Bīrūnī) (2002). *Al-Qānūn al-mas'ūdī*, vol. 1. Ed. by Sāmī al-Jundī, 'Abdulkarīm. Bayrūt: Dār al-kutūb al-'ilmiyya, 1422.
- Bahār, Muḥammad Taqī (Malik al-ṣu'arā') (ed.) (1939-1940). *Mujmal al-tawārīk wa 'l-qīṣaṣ*. Tih-rān: Kāwar, 1318.
- Chardin, Jean (1811). *Voyages du Chevalier Chardin en Perse et autres lieux de l'orient, nouvelle éd. par L. Langlès*, vol. 4. Paris: Le Normant, Imprimeur-Libraire.
- Ḳayyām (Ḥakīm 'Umar Ḳayyām) (1993). *Nawrūznāma: Risāla'ī dar munšā' wa tārikh wa ādāb-i jašn-i nawrūz*. Ed. by M. Mīnawī. Tih-rān: Kitābḱāna-yi Kāwa, 1312 (referred in this article as *Nawrūznāma A*).
- Ḳayyām ('Omar Chajjām) (1961-1962). *Traktaty*. Trans. by Boris A. Rozenfel'd; notes by Boris A. Rozenfel'd, Adolf P. Juškevič; with a facsimile of the Berlin MS Moskva: Eksmo (referred in this article as *Nawrūznāma B*).
- Ḳayyām ('Umar ibn Ibrāhīm-i Ḳayyām-i Nīšābūrī) (1978). *Nawrūznāma*. Second revised ed. Ed. by 'Alī Ḥaṣūrī. Tih-rān: Kitābḱāna-yi Ṭahūrī, 1357 (referred in this article as *Nawrūznāma C*).
- Kay Kā'ūs ibn Iskandar (1981). *Il Libro dei Consigli (Qābūs-nāma)*. A cura di Riccardo Zipoli. Milano: Adelphi.
- Ibn Miskawayh (1914). *Kitāb tajārub al-umam li-Abī 'Alī Aḥmad ibn Muḥammad al-ma'rūf bi Miskawayh*, vol. 1. Ed by. H.F. Amendroz, B. Atlaw. Baghdad: al-Muthanna Library (reprint).
- Ibn Miskawayh (1921). *The Concluding Portion of The Experiences of Ancient Nations by Miskawayhi (Reigns of Muqtadir, Qahir and Radi)*, vol. 1. Trans. by David Samuel Margoliouth. Oxford: Fox, Jones & Co.
- Pellat, Charles (trans.) (1954). *Le livre de la couronne, Kitāb al-tāj, ouvrage attribué a Ḡāḥiẓ*. Paris: Les Belles Lettres.

### Secondary sources

- 'Alī, Ṣ.A. (ed.) (1979). *Mā yuḥtāj ilayhi al-ṣāni' min 'ilm al-handasa li-Abū 'l-Wafā' al-Būzjānī*. Baghdad: University of Baghdad.
- Bagheri, Mohammad (2008). «Kūshyār ibn Labbān's Account of Calendars in his *Jāmi' Zīj*». *The Journal for the History of the Arabic Science*, 14, pp. 69-114.



- Bartol'd, Vasilij Vladimirovič (1966). «Bašnja Kabusa kak pervyj datirovannyj pamjatnik musul'manskoj persidskoj arhitektury». In: V.V. Bartol'd's opera omnia, vol. 4, *Raboty po archeologii, numizmatike, èpigrafiike i ètnografii*. Moskva: Izdatel'stvo vostočnoj literatury, pp. 262-266. Original ed. in *Ezhegodnik Rossijskogo instituta istorii iskusstv*, tom I, vypusk II, pp. 121-125. Petersburg: Rossijskogo Instituta Istorii Iskusstv, 1922.
- Bellosta, Hélène (2002). «Geometria pratica». In: *Storia della scienza*, vol. 3, *La civiltà islamica*. Roma: Treccani, pp. 506-525.
- Ben Miled, Marouane (1999). «Les commentaires d'al-Māhānī et d'un anonyme du Livre X des *Éléments* d'Euclide». *Arabic sciences and philosophy*, 9, pp. 89-156.
- Ben Miled, Marouane (2002). «La tradizione araba del Libro X degli *Elementi*». In: *Storia della scienza*, vol. 3, *La civiltà islamica*. Roma: Treccani, pp. 351-359.
- van Berchem, Max (1918). «Die Inschriften der Grabtürme». In: Diez, Ernst (Hrsg.), *Churasanische Baudenkmäler*. Berlin: D. Reimer, pp. 87-116.
- Bihruz, Dabih (1952-1953). *Taqwīm wa tāriḳ dar Īrān*. Tihrān: Anjuman-i Īrānvij, 1331. Īrān kūda, 15.
- Blair, Sheila S. (1992). *The Monumental Inscriptions from Early Islamic Iran and Transoxiana*. Leiden: E.J. Brill.
- Blair, Sheila S. (2003). «Gonbad-e Qābus (Kāvus), iii. Monument» (s.v.). In: *Encyclopædia Iranica*, 11 (2). New York: Bibliotheca Persica Press, pp. 128-129.
- de Blois, François (1996). «The Persian Calendar». *Iran*, 34, pp. 39-54.
- de Blois, François (2003). «The Reform of the Zoroastrian Calendar in the Year 375 of Yazdgird». In: Cereti, Carlo G.; Vajifdar, F. (eds.), *Ātaš-e dorun: The Fire Within: Jamshid soroush Soroushian Commemorative Volume*. San Diego: Mehrborzin Soroushian, pp. 139-145.
- Bosworth, Clifford Edmund (1965). «On the Chronology of the Ziyārids in Gurgān and Ṭabaristān». *Der Islam*, 40, pp. 25-34.
- Bosworth, Clifford Edmund (1996). *The New Islamic Dynasties: A Chronological and Genealogical Manual*. Edinburgh: Edinburgh University Press.
- Bulatov, Mitchat Sagadatdinovič (1978). *Geometričeskaja garmonizacija v arhitekture Srednej Azii IX-XV vv.* Moskva: Izdatel'stvo Nauka.
- Bulsara, Sohrab Jamsedjee (1953). «The old Iranian calendar». In: *M.P. Khareghat Memorial Volume*. Bombay: Shahnama Press, pp. 177-195.
- Cristoforetti, Simone (2002). *Il Natale della Luce: Il sada tra Baghdad e Bukhara tra il IX e il XII Secolo*. Milano: Mimesis.
- Cristoforetti, Simone (2003). *Izdilāq: miti e problemi calendariali del fisco islamico*. Venezia: Cafoscarina.
- Cristoforetti, Simone (2004). «Una premessa un po' più ampia dell'usato». In: Favaro, Rudy; Cristoforetti, Simone; Compareti, Matteo (a cura di),

- L'Onagro Maestro: Miscellanea di fuochi accesi per Gianroberto Scarcia in occasione del suo LXX sadè*. Venezia: Cafoscarina, pp. 7-15.
- Cristoforetti, Simone (2007). «The 'Hall of the Ambassadors' paintings in the frame of the calendrical systems of the Iranian world». In: Compagretti, Matteo; Cristoforetti, Simone, *The Chinese Scene at Afrāsyāb and the Iranian calendar*. Venezia: Cafoscarina, pp. 33-71.
- Cristoforetti, Simone (2009). «Kabisa», s.v. [online]. In: *Encyclopædia Iranica*, 15 (3), pp. 274-276. Available at <http://www.iranicaonline.org/articles/kabisa-intercalary> (2016-21-01).
- Cristoforetti, Simone (2014). «On the Era of Yazdegard III and the Cycles of the Iranian Solar Calendar» [online]. *Annali di Ca' Foscari. Serie orientale*, 50 (42), pp. 159-172. Available at <http://edizionicafoscari.unive.it/riv/dbr/9/13/AnnaliCaFoscari/50/149> (2015-12-01). DOI 10.14277/2385-3042/8p.
- Diez, Ernst (1918). *Churasanische Baudenkmäler*. Berlin: D. Reimer.
- Dihkudā, 'Alī Akbar (1957). *Luġatnāma*, š. mus. 34. Tihṛān: Čāphkāna-yi Majlis, 1336.
- Fedorov, Michael (2000). «The Khwarazmshahs of the Banū 'Irāq (fourth/tenth century)». *Iran*, 38, pp. 71-75.
- Godard, André (1939). «The Architecture of Islamic Period: An Historical Outline: D. Gurgān and the Gunbad-i Qābūs». In: Pope, A.U.; Ackermann, Ph. (eds.), *A Survey of Persian Art from Prehistoric Times to the Present*, vol. 2. New York; London: Oxford University Press, pp. 967-974.
- Hinz, Walter (1955). *Islamische Masse und Gewichte*. Leiden: E.J. Brill.
- Ideler, Ludwig (1825-1826). *Handbuch der mathematische und technische Chronologie*, vol. 2. Berlin: A. Rucker.
- Justi, Ferdinand (1895). *Iranisches Namenbuch*. Marburg: N.G. Elwert.
- Le Strange, Guy (1905). *The Lands of the Eastern Caliphate*. Cambridge: Cambridge University Press.
- Madelung, Wilferd (1975). «The Minor Dynasties of Northern Iran». In: R.N. Frye (ed.), *The Cambridge History of Iran*, vol. 4. Cambridge: Cambridge University Press, pp. 198-249.
- Mayr, Joachim; Spuler, Bertold (1961). *Wüstenfeld-Mahler'sche Vergleichungs-Tabellen*. Wiesbaden: Steiner.
- de Menasce, Jean (1975). «Zoroastrian Literature after the Muslim Conquest». In: Frye, R.N. (ed.), *The Cambridge History of Iran*, vol. 4. Cambridge: Cambridge University Press, pp. 543-565.
- Nafīsī, Sa'īd (1968). *Kitāb-i našīhatnāma ma'rūf ba Qābūs-nāma*, Tihṛān: Furūġī, 1347.
- Noci, Francesco (2008). «La diffusione del mausoleo in Persia all'epoca della dominazione buyide». In: Bredi, Daniela et al. (a cura di), *Scritti in onore di Biancamaria Scarcia Amoretti*, vol. 3. Roma: Edizioni Q, pp. 837-858.

- Panaino, Antonio (1996). «The Astronomical Conference of the year 556 and the Politics of Xusraw Anōšag-ruwān». In: Börm, Henning & Wiesehöfer, Josef (eds.), *Commutatio et contentio: Studies in the Late Roman, Sasanian, and Early Islamic Near East in Memory of Zeev Rubin*. Düsseldorf: Wellem Verlag, pp. 293-306.
- Panaino, Antonio (2010). «Nuove considerazioni sul Calendario Cappadocce. Persistenze e adattamenti dell'eredità achemenide nella storia di un piccolo regno tra mondo macedone, seleucide, attalide, partico e romano». *Electrum*, 18, pp. 159-173.
- Panaino, Antonio (2014). «A 'neglected' Source for the History of the 'reformed' Zoroastrian Calendar». In: Panaino, Antonio (ed.), *Non licet stare caelestibus: Studies on Astronomy and Its History offered to Salvo De Meis*. Milano; Udine: Mimesis, pp. 97-101.
- Rabino, Hyacinthe Louis (1936). «Les dynasties du Māzandarān de l'an 50 avant l'hégire à l'an 1006 de l'hégire (572 à 1597-1598), d'après les chroniques locales». *Journal Asiatique*, 228, pp. 397-529.
- Schroeder, Eric (1939). «The Architecture of Islamic Period. An Historical Outline. F. The Seljūq Period». In: *A Survey of Persian Art from Prehistoric Times to the Present*, vol. 2. New York; London: Oxford University Press, pp. 981-1045.
- Taqizadeh, Hasan (Sayyid Ḥasan Taqīzāda) (1937-1938). *Gāhšumārī dar Īrān-i qadīm*. Tih-rān: Čapḳāna-yi Majlis, 1316. Repr. with the author's notes appointed to the first edition in the 10th vol. of the *Opera omnia* ed. by Ī. Afšār, Tih-rān, 1357/1978-1979.
- Taqizadeh, Hasan. (1937-1939) «Various eras and calendars used in the countries of Islam». *Bulletin of the School of Oriental Studies*, part 1, 9 (4), pp. 903-922.
- Taqizadeh, Hasan (2010). *Il computo del tempo nell'Iran antico*. Ed. and trans. by Simone Cristoforetti. Roma: ISIAO.
- Vanoli, Alessandro (2008). «Tra cielo e terra: Idoli e immagini nel Mediterraneo medievale». *Miscelánea de estudios árabes y hebraicos*, 57, pp. 247-278.
- de Zambaur, Eduard (1927). *Manuel de généalogie et de chronologie pour l'histoire de l'Islam*. Hanovre: Heinz Lafaire.



### **3 Iconography on a Threshold**



## Borders

Itineraries on the Edges of Iran

edited by Stefano Pellò

# Flying over Boundaries

## Auspicious Birds in Sino-Sogdian Funerary Art

Matteo Compareti

(University of California, Berkeley, USA)

**Abstract** The focus is on the representation of auspicious birds in Sino-Sogdian funerary monuments. These birds can be portrayed with a halo behind the head and ribbons attached to their neck. Special emphasis is given to their connection with the mythical Iranian bird, the *Simurgh*, and the concept of Farr ('glory, charisma'). In particular, an attempt is made to shed some light on the possible association between the *Simurgh*, the 'Western' Phoenix, and the Chinese *Fenghuang*.

**Keywords** Fenghuang. *Simurgh*. Phoenix. Sino-Sogdian art.

Over the last twenty years, our knowledge of Late Antique Sogdian art and culture has grown enormously. This is mainly to be attributed, on the one hand, to continuous archaeological activity in those ex-Soviet republics where the Sogdian civilization flourished (central Uzbekistan and western Tajikistan) until the Arab invasion and the Islamisation of Central Asia beginning in the eighth century; on the other hand, important archaeological discoveries concerning Sogdian immigrants have been made in China in more recent times.

Highly mobile Sogdian tradesmen had begun to settle in different parts of Central Asia and China since at least the early fourth century. Epigraphic traces of the Middle Iranian language that they spoke have been found scattered over a wide area, from Sugdaia, in Crimea, to Japan. In fact, this Iranian people travelled everywhere in ancient times without insurmountable difficulties (de La Vaissière 2005). However, the Sogdians were perfectly aware of the so-called 'division of the world' according to the directions of the compass and the kingdoms that controlled a specific territory. The division of the world according to the Sogdians can be observed in the seventh-century paintings of the Hall of the Ambassadors at Afrasyab, where the northern wall was associated with China, the eastern one with India (and, possibly, the Turks), while the two remaining walls were devoted to Sogdiana itself. Chinese written sources reflect almost precisely such a division (Compareti 2009).

The same division of the world can be detected on Sino-Sogdian funerary

monuments that have been excavated in central China (mainly in Shaanxi Province). One of these funerary monuments that was unfortunately non-scientifically excavated – the Miho Museum couch – displays several panels embellished with the neighbours of the Sogdians during the mid-sixth century. In fact, at least two panels are dedicated to the Turks, two more to the Alchon Huns and some others to the Sogdians themselves. This division of the world does not correspond exactly to the one at Afrasyab or to Sogdian literary sources but it responds to a scheme that is well attested in Late Antique Iranian lands. Islamic written sources recorded the same division among the Persians during the Sasanian period (224-651) (Grenet 2005, pp. 129-130; Compareti 2009, pp. 68-70).

From the mid-sixth century, Sogdians had become subjects of western Turks, who controlled a wide territory. Sogdians could offer to the Turkish overlords their experience and infrastructures along the Silk Road network. Luxury goods and artistic forms could circulate relatively easily and even beyond ‘national borders’. For example, a Turk-Sogdian commercial embassy visited the Sasanian court in the second half of the sixth century and was treated in a bad way by the Persians. The Sasanian sovereign, in fact, bought the entire caravan of precious silk and burnt it in the public square in order to let the Sogdians and the Turks understand that the Persians were going to protect their commercial interests mainly directed to Constantinople (de La Vaissière 2005, p. 228).

Despite the hostility of the Sasanians, typically Sogdian textile motifs and other details of high status Persian nobles can be observed on a very controversial Sasanian rock relief at Taq-i Bustan. Most scholars agree that Taq-i Bustan is an unusual late Sasanian monument and the king there represented should be identified with a sovereign reigning between Khosrow II (590-628) and Yazdegard III (632-651) (Tanabe 2006; Mode 2006; Cristoforetti, Scarcia 2013). The fashion of the garments themselves, some of the weapons, and other details such as specific belts would point to a borrowing from the steppe peoples. For this reason, it is highly probable that also the decorative motifs that embellish those garments are actually an importation and not the result of the taste of Sasanian court weavers. In fact, no other Sasanian rock relief nor seals and sealings or luxury objects of possible late Sasanian origin have been decorated according to stylistic standards observed at Taq-i Bustan (Compareti 2005; Canepa 2014).

Undoubtedly some decorative motifs in Sogdian art represent an interesting case of adoption and adaptation of Hellenistic forms that reappeared over a very long time span in Central Asia, also during the fifth/sixth-century ‘classical revival’. The most important phases of this process are well distinguishable such as the phenomenon of adaptation to typically Iranian concepts and, subsequently, their return from east to west according to dynamics seemingly unsuspected (Compareti 2013a).

For some reasons, investigations in the history of art of the Sasanian



period have been affected by prejudices and uncritical attributions in the past that just resulted in a worsening of the problems in the field of Iranian studies. The present paper, on the contrary, does not dislike to be possibly affected by that 'revisionist' trend that is simply critic of prejudicial theories concerning adoption and adaptation. Approximately ten years ago, for example, Ciro Lo Muzio proposed reconsidering the old theory of the 'Parthian shot' with very good evidence. According to his arguments, this motif would have been introduced into Sasanian Persia (and the Far East) from the Central Asian steppes and not the opposite (Lo Muzio 2003, pp. 529-533). I think that the case of the so-called *Simurgh* of Taq-i Bustan presents similar problems.

Some scholars of mythological studies consider the decorative element I would like to consider in this paper, namely the *Fenghuang* of Chinese literature, to be the 'Western' Phoenix. However, someone else had understood long ago that such a superimposition was not to be regarded as automatic but just conventional. In his ground-breaking study on Tang exoticism, Edward Schafer proposed associating the *Luan*, the second most important fantastic bird of Chinese literature after the *Fenghuang*, with the *Simurgh* of Iranian mythology. Schafer (as many other scholars) was perfectly aware that the *Fenghuang* did not correspond precisely with the Phoenix just as the *Luan* bird was not the *Simurgh*; nevertheless, in his opinion, all these identifications could be maintained because they had become popular among Western scholars (Schafer 1963, p. 288; Willets 1965, pp. 151-154; Rawson 1984, pp. 99-107; Diény 1989-1990; Alabisio 1994; Salviati 1994).

A 'superimposition' of fantastic creatures belonging to different cultural milieu such as the one proposed by Schafer presents a series of problems. First of all, it does not consider the possibility of a direct relation between the Phoenix and the *Simurgh*. Then it must be kept in mind that the situation was not the same among Iranians (Persians and Sogdians) during the pre-Islamic and the Islamic periods just as it was different in China during the Sui-Tang and the Song-Yuan dynasties. When Persia, Central Asia, and China were unified under the Mongols between the mid-thirteenth and mid-fourteenth centuries, some cultural traits began to be facilitated in being accepted everywhere in the empire. The representations of both the *Fenghuang* and the *Simurgh* were standardised in the sphere of visual arts only in the Mongol period, and the Chinese model decoded by the post-Tang (most likely Song) artists was to be accepted also in Persian Islamic book illustrations. Therefore, it is extremely difficult to trace the iconography of the *Simurgh* in the Iranian world during the pre-Mongol period, while something useful can be traced in Sogdian art. Moreover, the very iconographic characteristics of single birds in specific contexts are not easily determined and are sometimes confused with those of other similar creatures from the same cultural milieu, such as happened with the *Fenghuang* and the *Luan*.

These are just some of the points that will be considered in this study with the support, whenever possible, of written sources.

In the first instance, it is important to determine the basic relationship possibly existing between the *Fenghuang*, the *Simurgh*, and the Phoenix. As has already been mentioned above, the *Fenghuang* was confused by the Chinese with the *Luan* and another bird that was very often represented in funerary art from the Han (206 BCE-220 CE) to the Tang (618-906) dynasties, namely the *Zhuniao* or 'Red Bird of the South', also called by other names such as *Zhuque* and *Chiniao*.<sup>1</sup> While for the *Fenghuang* and the *Luan* we have only literary descriptions, the *Zhuniao* can be identified without major problems in Chinese funerary paintings especially from the Tang period because it is usually (but not always) represented on the wall facing south in traditionally organized graves.

The *Zhuniao* was one of the *Siling* 'Four Divine Creatures' or *Sishen* 'Four Divine Gods' of Chinese culture, together with the *Baihu* 'White Tiger' symbolizing the West, the *Qinglong* (or *Canglong*) 'Green Dragon' for the East, and the *Xuanwu* 'Dark Warrior' of the North.<sup>2</sup> These same types of Chinese graves where each cardinal point was symbolized by a fantastic creature or animal were later exported to Korea and Japan as well (Berthier 2001; Jeon 2005, pp. 170-171). In Han engraved and painted tombs, several fantastic and apotropaic creatures are accompanied by their own names, usually written in a cartouche above the head. However, curiously enough, the bird that has been commonly identified with the *Fenghuang* rarely appears together with its name, despite some controversial information that has been reported in the past (Diény 1989-1990, p. 4). *Zhuniao* birds present inscriptions sometimes (Erickson 2011, p. 10), but their identification is easier to be determined because of their funerary functions. One low relief image of a *Zhuniao* bird from a second-century tomb

---

1 Fantastic birds appeared in Chinese funerary art long before the Han dynasty, although their relationship with the *Fenghuang* and the *Zhuniao* is not completely clear (Diény 1989-1990; Salviati 1994).

2 Substitutes for these four combinations could also have been: the *Lin* of the West, the *Feng* of the South, the *Gui* of the North and the *Long* of the East (Wong Pui Yin 2006). *Feng* is just another name for *Fenghuang* and *Gui* is the Turtle. *Lin* is another name for *Qilin*, a fantastic creature of Chinese mythology usually rendered in English as 'Unicorn'. However, this superimposition presents the same problems as for the *Fenghuang* and the Phoenix; the same could be said with respect to the *Long*, usually translated as 'Dragon'. As is the case with *Fenghuang*/Phoenix, also *Lin*/Unicorn and *Long*/Dragon should be regarded as conventional and not precise translations. At any rate, it is worth observing that in Iranian culture too every direction of the compass is symbolized by the same specific colour which is to be found in the Chinese tradition (Scarcia 1985). According to some Muslim authors, not only colours but animals too could point at the kings of different parts of the Sasanian Empire. For some specific references about the kings of east Caucasian regions who were invested by Khosrow I with titles, gifts, and robes embellished with specific images of animals, see Gadjiev 2006, pp. 204-205.

in Quxian (Sichuan Province) presents already the typical characteristics of the *Fenghuang* of the Tang artists (Pirazzoli-t' Serstevens 1982, pp. 167-170, fig. 109). On one clay tiles from the fifth-sixth century well-known site of Dengxian (south-western Henan) at present kept in the National Museum in Beijing, there is also one typical *Zhuniaio* bird. On other tiles from the same site there are also the remaining directional creatures and several other subjects. Curiously enough, however, two Chinese characters appears on the right of the bird undoubtedly identifying it as a *Fenghuang* (Juliano 1980, pp. 38-40, fig. 16). It is then clear that some confusion already exists about the identification of fantastic birds during the Southern Dynasty period. Also these points deserve some further investigation.

Among the most interesting Chinese texts where the *Fenghuang* is mentioned, the *Shanhai Jing* or *Classic of Mountains and Seas* stands apart. This is a text about every kind of exoticism and fantastic creatures according to Chinese imagery that has been preserved in its second/first-century BCE Han redaction. Later interpolations can be recognized and only in more recent times, around the beginning of the seventeenth century, illustrated versions began to appear. The description of the *Fenghuang* in the *Shanhai Jing* and Chinese literature in general is not detailed. It is described as an auspicious creature associated with music and Taoist immortals and, for this reason, it was especially indicated to be represented on graves. The tree where the *Fenghuang* lived was located on top of a mountain that, according to Chinese traditions, was the place where immortals lived.<sup>3</sup> Its association with the colour red and fire is probably recorded because of the confusion with the *Zhuniaio*. Some characteristics of the *Fenghuang* do not seem to belong to the original 'religious' background of that fantastic bird but, most likely, to the sphere of legends and tales that, as always happens in these cases, started to develop at a popular level. In the *Shanhai Jing* it is specifically reported that auspicious Chinese characters were scattered on its body.<sup>4</sup> Although it is not always possible to establish how ancient and accurate all these descriptions are, it is at least clear why the *Fenghuang* has been associated with the Phoenix. The *Fenghuang* and the Phoenix are not only described both as fantastic birds, but they also share a series of supernatural characteristics. For all these reasons, the first Western literati who began to approach the study of Chinese culture could have chosen a name for the *Fenghuang* as much evocative as possible, and the Phoenix should have appeared as the most appropriate.

3 The association mountain-*Fenghuang* is not completely clear. A very interesting seventh/eighth-century CE textile fragment excavated at the cemetery of Astana (Turfan, Xinjinag Province) shows a typical Tang *Fenghuang* on top of a mountain with plants, birds, and clouds in Chinese style surrounding it (Turfan Museum 1992, fig. 182).

4 For a translation into Italian, see Fracasso 1996, pp. 14-15. The *Shanhai Jing* has been translated into English too (Birrell 1999). Both publications have been reviewed (Company 2000).

Not many studies have been devoted to the association *Fenghuang*-Phoenix, but a very interesting paper on this topic was published by Jean-Pierre Diény some years ago (1989-1990). Diény especially focused on the similarities between these two fantastic birds. He concluded that, even if there are some common features, these are only superficial traits and, when considered in detail, they also present discrepancies.

Every ancient culture had its own cosmic bird that shared common characteristics, the most important ones being the giant size and longevity. They are usually mysterious creatures and very vague descriptions are given in ancient literary texts. Just to mention some of these fantastic birds that had called the attention of scholars because of their possible association with the Phoenix, here are some specimens: the ancient Egyptians had the *Benu*; the Arabs the *'Anqa* or the *Rukh*; the Jews the *Ziz*; the Yezidi *Melek Ta'us*; the Indians *Garudha*; the Tibetans *Khyun*; the Hungarians *Torul*, etc. The ancient Slavs represent a specific case in this list because one of the deities of their pre-Christian pantheon was named *Simar'gl*. Its aspect is not completely clear but, according to some scholars, this deity was represented as a bird. Moreover, it is not excluded that *Simar'gl* was an Iranian borrowing specifically rooted in the figure of the Iranian *Simurgh*, although not every scholar agrees on this point (Compareti 2006, pp. 190-191; Compareti, Cristoforetti 2012; Álvarez-Pedrosa 2014, pp. 66-67). Associations between birds belonging to different cultural milieu were only normal and could have been advanced not only by contemporary scholars but also by ancient observers. For instance, it would be worth noting that in modern Armenian the word for peacock is *siramarg*, with very small dialectal variants. This term too seems to be a clear Iranian borrowing from *Simurgh*<sup>5</sup> because of the tight relationships between Armenia and Persia both in pre-Islamic and Islamic periods.

In the Iranian world, a fantastic bird traditionally associated by some scholars with the Phoenix and (in part) the *Fenghuang* is the *Simurgh*. Also for this bird there has been much speculation among scholars; therefore, a short summary would be useful. All the following information can be found in a fundamental article on the *Simurgh* by Schmidt that, however, presents major methodological problems and, in the light of some more recent publications, should be considered with great caution.<sup>6</sup>

---

5 The main study on Iranian and specifically Zoroastrian elements in Armenian is Russell 1987, pp. 308-309. For some interesting considerations about Iranian elements in Armenian art, specifically for the representation of hybrid creatures, see Curatola 1978.

6 After his first paper, Schmidt (1980a) published a second study that presents the same methodological problems (Schmidt 1980b). His problematic approach to the *Simurgh* in Persian literature and visual art has been uncritically embraced until very recent times (Grossato 2004).

The name above all: already in Avestan language a fantastic bird called *Marego Saeno* is mentioned; during the Sasanian period, it would have become *Senmurv* in Middle Persian (or Pahlavi), while *Simurgh* is the Neo-Persian (or Farsi) name: quite obviously, both the Middle Persian and the Neo-Persian forms point to the same fantastic bird. It is very important to clarify this point because, in recent times, some scholars added some more confusion to the problem in regarding the *Senmurv* and *Simurgh* as two distinct creatures (Charritat 2001; Leclerc 2001).<sup>7</sup> Islamic texts such as the national epic of the Persians (the *Shahnameh* or *Book of Kings*) and some Zoroastrian texts (that, in any case, have all been written down only after the Islamisation of Iranian lands) give some descriptions of the *Simurgh*: this is a giant bird that lived in a tree on top of a mountain in the middle of a sea. It was associated with time, fire, and music. Its connection with the pre-Islamic Iranian god of time Zurvan offers a clear parallel with the association between the Phoenix and the god Aion, the Greco-Roman counterpart of Zurvan (Scarcia 2003; Compareti, Scarcia 2012, pp. 224-226, 241; Grosserez 2013, pp. 37-45).

The most important story about the *Simurgh* is featured in the *Shahnameh*: the *Simurgh* 'kidnapped' and suckled the hero Zal, abandoned as a baby because of his albinism, which is family regarded as a demonic.<sup>8</sup> Once Zal grew up strong and healthy with the help of the *Simurgh*, he joined his contrite father and ruled in eastern Iran, precisely in the region of Zabulistan, between modern eastern Iran and western Afghanistan. Both Zal and his son Rustam were protected by the *Simurgh* and they were able to summon it in case of need just by burning one of its feathers.

In the famous mystical poem *Mantiq al-Tayr* (The Conference of the Birds) by Attar (ca. 1145-1221), the author plays on the similarity between the name *Simurgh* and the Persian word for 'thirty birds'. A large group of the world's birds, who represent different human qualities, set off in search of the king of the birds (*Simurgh*). Many of them drop out along the way. When the surviving thirty birds (*si murgh*) arrive in the land of the *Simurgh*, they learn that their journey has been about seeing themselves for who they are. Clearly Attar did not write a poem on the *Simurgh sensu strictu* but just used it as a pretext to discuss human self-awareness;

7 This assertion is clearly indebted to the hypothesis formulated by Camilla Trever that will be discussed below, and reminds us of the «two fantastic animals *senmurv* and *simurgh*, iconographically different but sharing the same etymology» (Curatola 1989, p. 51; cf. p. 43 on the Islamic iconography [i.e. the *Simurgh*] «turned away from the universal prototype of the hippocampus» [i.e. the *Senmurv*]). On the same line «the term *sēnmurv*, literally meaning dog-bird» [Gyselen 2010, p. 228]).

8 The fact that the *Simurgh* was able to nurse Zal has been possibly at the origin of the mammal features that have been attributed to this fantastic bird (Cristoforetti, Scarcia 2013, pp. 340-341).

nevertheless, it is worth noting that he knew that the *Simurgh* was a bird and not something else.

But let us come to the representation of the *Simurgh* in Iranian art following the risky identification by Camilla Trever.<sup>9</sup> In her opinion, the *Senmurv* (and the *Simurgh* too!) would have been a winged composite creature with the head and paws of a dog and a peacock's tail. Despite several doubts raised by some scholars (including Schmidt) that somehow criticized Trever's identification, her theory persisted for a very long time. Only recently her identification has been proved incorrect and new ideas on the real iconography of the *Simurgh* have been produced. In brief, the *Simurgh* has always been represented as a fantastic bird, and the hybrid creature with wings, a dog-face, and peacock's tail should be rather regarded as a representation of *Farr*, that is, 'glory' or 'fortune' (the problem is discussed in Compareti 2006).

Exactly as occurred with the *Fenghuang* and the Phoenix, the *Simurgh* too was probably confused by ancient authors with other fantastic birds that can be found in Persian myths. Without entering too deeply into the question, one can consider briefly another aspect of the *Simurgh*, that is, its connection with the concept of *Farr(eh)* (Middle Persian *Xwarrah*, Avestan *Xwarenah*), which could be translated as 'glory', 'fortune' or 'charisma' and was essential for every Iranian king in order to rule. Both in Zoroastrian and Islamic Persian literature, this Iranian charisma can take several forms, and, among these, also the shape of a bird.<sup>10</sup> In the Avestan myth, the *Xwarenah* turned away Yima in the form of the *Vareghna* bird, which has been identified with a falcon because of some representations on ancient coins (Grenet 2012). Another important bird in Zoroastrian religion that was associated with Yima as well is the *Karshiptar*. We know of it as the propagator of Zoroastrian religion only from written sources and it has never been identified in visual arts (Redard 2012). Possibly, the

---

9 Her paper, originally written in Russian (1938), was published in English ten years ago (Trever 2005).

10 For an updated discussion about the iconography of Zoroastrian deities and specifically on this point, see Shenkar 2014, p. 132. According to Schmidt the *Farr* can be symbolized in the *Shahname* by the ram, the *Simurgh*, the peacock, and, possibly, even the onager. He was not convinced by these descriptions and, in the end, he represented the *Farr* as a mountain sheep with the wings of a *Simurgh* and the tail of a peacock (Schmidt 1980b, p. 169). Other scholars have since then proved that his description should be corrected, since in the *Shahname* the *Farr* appears to be a composite creature named as *Ghurm*: a mysterious animal with the wings of the *Simurgh*, a peacock's tail and head, and ears and hooves like those of *Rakhsh* (Rustam's horse), red in colour and as swift as the wind. The description is quite obscure but, at least in this case, it is clear that the *Farr* is not represented as a *Simurgh* nor as a peacock. And such a description excludes that it is a ram, although *ghurm* can literally mean 'male mountain goat' in Persian (Cristoforetti, Scarcia 2013, p. 342). According to Middle Persian epic literature, *Farr* in the shape of an eagle saved the first Sasanian king (Boyce 1983).



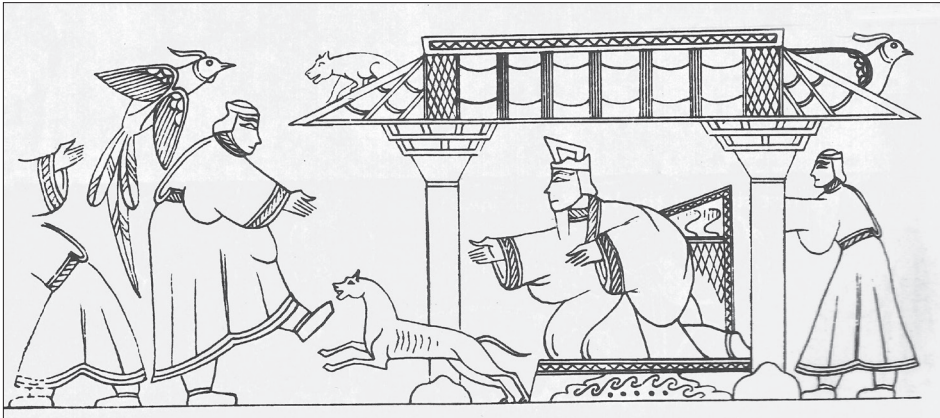

Figure 1. Line drawing from the Wu Ban shrine (145 CE), Shandong Province (Liu, Yue 1991, p. 87)

only companion of the *Simurgh* explicitly mentioned in Middle Persian Zoroastrian texts is the *Chamrush* bird, whose main function is to peck the enemies of Iran as if they were grains (Boyce 1975, p. 43). Also in this case, its large size is implicit because it is represented as a bird of prey. One last bird attested in Persian literature is the *Homa*, whose name is clearly connected with kingship; yet, even if it also could remind of the Phoenix, its ornithological identification is doubtful (Curatola 1989, p. 51). There are no specific studies devoted to this important bird, described in the *Shahnameh* as «the bird of royal fortune (= *Farr*)» or «whose feathers symbolize *Farr*». Clearly the descriptions of all these birds are generic in nature and only the *Simurgh* is portrayed in Islamic book illustrations. However, the iconography of the *Simurgh* also present some problems.

Another aspect should be considered from the iconographic point of view. Diény already called attention to the representation of the *Fenghuang* and the Phoenix as legendary and symbolic creatures. Even if they are described in written sources as composed of parts of existing birds, they cannot be expected to have a model in nature, despite all the efforts that some scholars made in order to find a convincing real counterpart (peacocks and pheasants were usually indicated). As already observed above, the *Fenghuang* and *Zhuniaio* shared many characteristics and, for this reason, it is impossible to distinguish between them. A bird usually represented with spread wings, an element above its head, and a long



Figure 2. Reproduction of the Zhuniaio from the tomb of Gao Yuangui (d. 756) (Zhang 1995, fig. 194)

tail appears quite often in Han funerary art (fig. 1).<sup>11</sup> This bird could be at the basis for the image of the standardised representation of the *Zhuniaio* as it can be observed in eighth and ninth-century Tang funerary paintings (fig. 2) (Zhang 1995, figs. 190, 194, 209); nevertheless, as already observed above, a very similar funerary iconography already existed in

11 One of the most interesting Chinese funerary monuments of the eastern Han period is represented by the Wu family shrines, a group of above-ground graves embellished with magnificent reliefs (Wu 1989). Among the numerous narrative scenes of the Wu family shrines there are also auspicious birds. These creatures are not just portrayed as usual above buildings or doors but among people as much often in the open air as well as inside enclosed rooms. Very often they look as if they are pointing at the person who should be regarded as the most important in a group of people. The long tail and the feathers on the head are reminiscent of the representation of the *Fenghuang/Zhuniaio* (Liu, Yue 1991, pp. 61, 70, 86-87, 91-93). It should not be excluded that, if a sixth-century Chinese observer with some knowledge of traditional Han motifs had the occasion to see the decorative birds in Sino-Sogdian monuments, a parallel with auspicious birds in Chinese art could have appeared nothing but natural in his mind. Fantastic birds started to appear more frequently in Han art during the second century CE when in Hellenized Bactria a bird resembling the Classical Phoenix can be sometimes observed (Hackin 1939, fig. 92).





Figure 3. Fenghuang/Zhuniao from a tomb in Dengxian (5th-6th century), Henan Province (Juliano 1980, fig. 16)

second-century Han art such as at Quxian.<sup>12</sup> However, the most interesting representation of a fantastic bird among the funerary directional animals of Chinese culture (and certainly identifiable with the Fenghuang because of an inscription) appears on a clay tile in the fifth-sixth century Dengxian grave (fig. 3) (Juliano 1980, fig. 16). Luxury Chinese goods destined for export and embellished with representations of a bird identified as the *Fenghuang* show exactly this iconography. It is this standardized *Fenghuang* that can be observed on some tenth and eleventh-century Byzantine objects of art possibly produced in Constantinople itself. Byzantines probably accepted this model, deeply rooted in Chinese art of the Tang period, because of their identification of that bird with the Phoenix. Moreover, its exotic traits emphasised the provenance of the Phoenix, which was considered to live in distant lands (Walker 2008; Walker 2012, pp. 53-56, 71-77).

<sup>12</sup> This is not the only problem about fantastic birds in Han art, because the sun was traditionally represented as a disc with a dark bird inside, while the moon had the toad or the rabbit as its symbolic animals. As it is recorded in written sources (and also in the above mentioned *Shanghai Jing*), this solar bird was considered to be a crow (sometimes three-legged) and it was also portrayed like a crow in Han art, the most famous specimen being the painted silk banner from *Mawangdui* tomb 1, Changsha (Hunan Province, 168 BCE) (Loewe 1979, pp. 50-53, 127-133; Pirazzoli-t'Serstevens 1982, fig. 23). The traditional Chinese solar bird would have been iconographically transformed into a typical *Fenghuang/Zhuniao* most likely during the (late?) Tang period. This is particularly evident in Buddhist paintings, such as in the late ninth-early tenth-century painted book cover from Dunhuang Cave 17 at present preserved in the British Museum (OA 1919.1-1.0207; Whitfield, Farner 1990, fig. 78).

One exhaustive study on the Phoenix exists, including also a description of this creature in art forms (Van den Broek 1972). Fortunately, following Classical traditions, inscriptions are added to some representations of this fantastic bird. One early third-century Syriac inscribed mosaic from Edessa (modern Urfa, in southern Turkey) is particularly interesting because the Phoenix is clearly identified by an inscription and, at the same time, does not present typical fantastic traits but looks more like a peacock (fig. 4; Van den Broek 1972, pl. XIII). More ancient inscribed representations of the Phoenix are known in Greco-Roman paintings such as in the first-century C. Euxinus' inn in Pompei (Archaeological Deposits inv. 41761; cf. Zambon 2004, p. 19), although the inscription in the specimen from Edessa is much clearly pointing at the fantastic bird on the altar. The Phoenix was as much equally important during the pagan and the Christian periods. It was represented very often on sarcophagi and apsidal mosaics in churches because of its connection with immortality (Amad 1988; Dulaey 2013). Usually, it was standing on an altar or a palm tree: there was an obvious connection between the fantastic bird of immortality and this tree, which in Greek was just called *phoinix*, just as the eastern land where the nest of the Phoenix was located, Phoenicia.<sup>13</sup> Actually, there was some confusion about its place of provenance, because it was said to come from India, Ethiopia, South Arabia, etc. The mountain where the tree with the Phoenix nest was traditionally located has been identified as the Mount Casius, in modern Syria (Van den Broek 1972, pp. 63-65).

In any case, the bird identified with the Phoenix in Greco-Roman art looks more like an ibis, a heron, or a peacock, with a decorative element resembling a feather on the top of its head, long legs and, usually, a halo. Many of these iconographic traits have been borrowed from Egyptian art. In fact, as Herodotus recorded (II, 73), the Phoenix was originally the bird of the city of Heliopolis, in Lower Egypt. It is not excluded that the Phoenix could have been confused in Greco-Roman religion with a series of divine hypostases in the form of birds. Although there are several pagan gods who were accompanied or symbolized by a fantastic bird, it is the eagle of Zeus that appears to be the most interesting. Zeus could manifest himself as an eagle or could send his giant bird as a messenger or as a raptor like in the myth of Ganymede. Moreover, the association between the eagle and the lightning of Zeus could be another point in common with the Phoenix and fire. There is another epithet that should not be neglected: according to

---

**13** Most likely it is the reddish colour of the date to be at the base of such an association, and Phoenicia was the place of production of an animal pigment (purple) used in ancient times to dye precious clothes. Curiously enough, the same name *phoinix* can be referred in Greek to a horse (or even a bull) whose colour is reddish. It can be found in the *Iliad* (23, 454) as referred to a reddish horse with a white sign on its forehead «round as a (full) moon» that was the leader of a group of horses «flying in the plain and moving the dust».

some ancient authors, the eagle that was sent to torment Prometheus was also called the 'dog of Zeus' (Compareti, Scarcia 2012, p. 240). It is not necessary to discuss all these unusual instances of Classical mythology in detail. For the moment, it is enough to consider that some connection between the eagle of Zeus and the Phoenix probably existed. It is also worth noting that, unlike the Phoenix, the *Fenghuang* is never connected to an idea of rapacity. On the contrary, rapacity is a peculiarity of the *Simurgh*.

Even if the connection between the Phoenix and rapacity is not completely clear, it is interesting to observe that in Arabic the Phoenix and the *Simurgh* are both translated as '*Anqa*, that was also a raptor (Zakharria 2002). Another fantastic bird of Arab legends that was a raptor is the *Rukh* (Bivar 2009). In the Islamic period, the Phoenix was translated also with a specific term in Arabic and Persian: *Samandar*, clearly from 'salamander'. As it is well-known, this animal was commonly associated in alchemy with the element fire. Also in Medieval Europe the salamander was considered to be the only animal that could enter fire without any damage.<sup>14</sup> No doubt, the identification *Samandar*/Phoenix became popular during the Islamic period because of the association of both creatures with fire (Miquel 1980, pp. 363-364). Something more should be observed. In fact, *Samand* in Persian means 'horse' or, better, 'steed'. This is another element that contributed to generate confusion in the representation of the Phoenix, which began to be described as a horse. But why a winged horse? According to one Islamic legend, the Prophet Muhammad himself saw a pillow belonging to his wife that was decorated with winged horses and hysterically began to laugh to the point that he was going to die (Noja 1983). This could clarify the genesis of both the wings of the horse and the Islamic topos of a terror causing such an irrepressible laughter to be the cause of death: the re-reading of the both tragic and 'phallic' myth of the Gorgon Medusa/Baubo (Vernant 2013, pp. 40-41) who gave birth to Pegasus from her 'vaginal' beheaded neck. In fact, Medusa did not only petrify people but she could provoke such a strong laughter in whoever looked at her monstrous face (vagina) to cause his death. Hence the Islamic odd Pegasus renamed *Samand* as horse and *Samanda-salar*<sup>15</sup>

<sup>14</sup> Medieval legends were in general rooted in Greco-Roman traditions. It is worth noting that in the first century CE Pliny the Elder mentioned the salamander several times, yet it seems that he didn't believe in the association of this animal with the element fire. In one passage (XXIX, 23), Pliny explicitly (and curiously) says that the Magi transmitted the information about the salamander and its capacity to extinguish fire. This point also deserves further investigation.

<sup>15</sup> *Samanda-salar* is G. Scarcia's reading, as opposed to *Samand-i Aslar*, *salar* being a bird not identified but recorded in Dozy.

as winged horse not only appears as *Samandar*, that is Phoenix,<sup>16</sup> but also superimposes its own image to the functions of the *Simurgh* in a text studied by Irène Melikoff (1962, p. 39). This odd creature could even kill itself with laughter just looking at its image into a mirror (another echo of the Greek myth of Medusa).<sup>17</sup> Something similar occurred in the history of the construction of the lighthouse of Alexandria that was constantly boycotted by aquatic monsters and demons. Alexander the Great was able to get rid of them by submerging a portrait of those demons into the water, thus causing their flight (Miquel 1988, pp. 99-101).

Superimposition of images belonging to different cultural milieu seems to be a normal phenomenon that could easily supersede borders and inimical neighbours during Late Antiquity. However, the mechanism is much more complicated. Several aspects should be considered despite the lack of written sources and numerous gaps to be filled in. For example, if the Arabs identified the *Simurgh* with the *'Anqa* that, for its part, was confused with the *Samandar* (or winged horse) this does not mean that the *Samandar* could be automatically regarded as the *Simurgh*. As already observed, the identification of the *Simurgh* as a hybrid creature is an error that has caused several problems to art historians. In fact, the *Simurgh* should always be considered to be a bird.

Representations of the *Simurgh* in Persian art appear only in book illustrations accompanied by texts that began to be copied during the Islamic period. There are unfortunately no illustrated *Shahnameh* or other texts that can be dated to the period before the Mongol conquest of Persia and the institution of the Ilkhanid dynasty (1256-1353). It could be stated that the art of book illustration in Persia developed greatly after the coming of the Mongols and it is precisely because of the unification of China, Central Asia, and Persia that many elements typical of Chinese art were adopted by Ilkhanid artists (Grube 1978).

The *Simurgh* is an emblematic figure because its image began to be represented in Persian painting according to the standardised representation of the *Fenghuang* at the time of the Song dynasty (960-1279). The most an-

---

16 The identification is extremely clear in the definition of *Semenda* pertaining to the «extreme borders of India» as reported by Niccolò de' Conti (1395-1469): that Far East where the Phoenix/*Semenda* is inextricably connected with both the winged horse and music (Scarcia, Vercellin 1970, p. 45). For some further information on music, once more in connection with the myth of Medusa, see Cristoforetti (unpubl.).

17 There are at least two Turkish book illustrations reproducing a hybrid human-headed snake looking into the mirror that a man is holding in front of it. One of them is dated ca. 1582 (M.788, f. 89v) and it is at present kept in the Pierpont Morgan Library, New York (Schmitz 1997, p. 83, fig. 120). The second illustration (suppl. turque 242, f. 90v) is dated to the same period and it is kept in the Bibliothèque National de France, Paris (Stchoukine 1966, pl. 46). The subject is discussed in Scarcia 2003, pp. 16, 19-20; Compareti, Scarcia 2012, p. 240.





Figure 4. Phoenix with Syriac inscription from a tomb in Edessa (235-236) (Van den Broek 1972, pl. XIII)

cient representation of a *Simurgh/Anqa* in a Persian book illustration aiming at a Chinese style was copied in Maraghe around 1297-1300 (M.500, f. 55). The book is not a copy of the *Shahnameh* but a translation from Arabic, the *Manafi'-i hayavan* (*The Benefits of Animals*) by Ibn Bakhtishu' (fig. 5) (Schmitz 1997, p. 21, fig. 26). The model for this *Simurgh* is definitely not the Tang *Fenghuang/Zhuniao* but something different that followed the development of Chinese art of the post-Tang period. Its tail, wings, and the long legs are all stylistically close to the iconography of the *Fenghuang* under the Song, although the Chinese bird is expected to be represented flying in the air. On the body of this *Simurgh/Anqa* some flames that could be confused with feathers appear: is this an allusion to the element fire? It is not excluded that this 'flaming feathers' are at the basis of the typical representation of the Persian *Simurgh* following Chinese style, that is to say, with such an elaborated tail. It is solely this Chinese iconography that would have become common for the representations of the *Simurgh* in Persian painting until very recent times.<sup>18</sup>

<sup>18</sup> One other Phoenix is reproduced in another illustration in the same manuscript (M.500, f. 84v). The fantastic bird is flying in front of Salomon who, according to the legend, was able to speak the language of animals. However, the Phoenix paying homage to Salomon is



Figure 5. Simurgh/ 'Anqa from a copy of the *Manafi'-i hayavan* (M.500, f. 55), The Pierpont Morgan Library (1297-1300) (Schmitz 1997, p. 21, fig. 26)



Figure 6. Sam, Zal and the Simurgh. Folio from a *Shahname* copied in Shiraz (1333). St. Petersburg, State Public Library, (ex-Dorn 329) (Swietochowski, Carboni 1994, fig. 25)

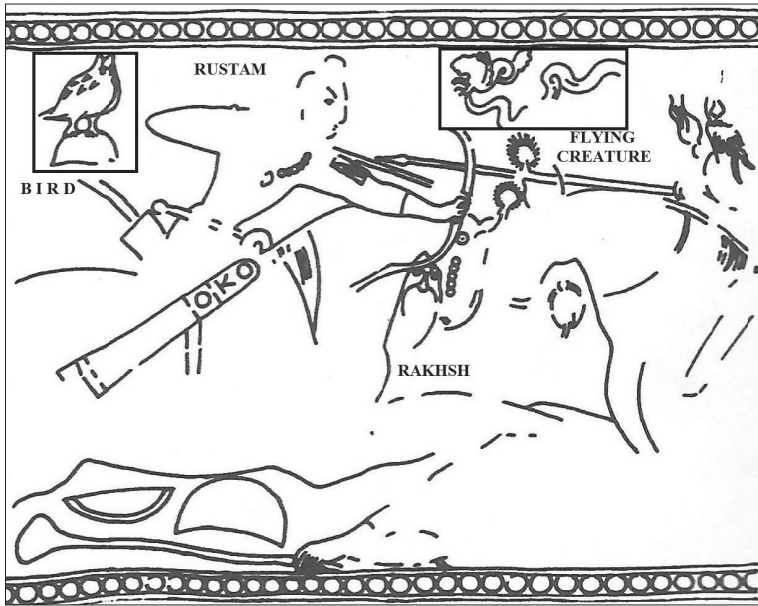

Figure 7. Line drawing of the 'Rustam painted program', south-eastern corner, from Penjikent, room 41 sector VI. (ca. 740 CE) (Marshak 2002, fig. 16)

Just one small group of Persian book illustrations from the Fars province or Isfahan and dated to the Injuid period (ca. 1325-1353) does not follow the Chinese style. The 'Injuid *Simurgh*' is portrayed standing and not flying, with a long tail - yet different from the Chinese model -, and some elements on its head resembling feathers or little horns. In general terms, that *Simurgh* looks more like an owl or, in some cases, a rooster (fig. 6).<sup>19</sup>

The only point of comparison for this kind of *Simurgh* is to be found among the mid-eighth-century Sogdian paintings from the Blue Room at Penjikent (fig. 7) (Azarpay 1981, pp. 95-125; Marshak 2002, pp. 25-52, fig. 16). The entire room (41 sector VI) is covered with a painted programme depicting Rustam's trials. However, I think that the *Simurgh* - that

much different from the elaborated one appearing in the illustration described above. In fact, several paintings of this manuscript could be attributed to different artists, possibly a master and his disciples (Grube 1978, p. 5, fig. 1).

**19** One of the most interesting specimens has been published some time ago in Swietochowski, Carboni 1994, fig. 25 (Saint Petersburg, State Public Library, ex-Dorn 329). The figure of the rooster and its association with Persia should not be underestimated. In fact, several Classical authors recorded its importance for the Persians to the point that the rooster was described as the 'Persian bird' par excellence (Tuplin, 1992; Compareti, Scarcia 2012, pp. 238-239, 243).





Figure 8. Line drawing of a panel from the 'Vahid Kooros' funerary couch (second half of the 6th century) (Riboud 2004, fig. 12)



Figure 9. Line drawing of a panel from the 'Vahid Kooros' funerary couch (second half of the 6th century) (Riboud 2004, fig. 28)

is the most obvious companion of Rustam together with his horse *Rakhsh* – should not to be identified as the winged composite creature flying in front of the hero but as a standing bird resembling an owl appearing only once in the entire painted programme. In my opinion, this specific scene could be a very important moment in the sequence about Rustam's trials, when the hero is in particular need of the protection of the *Simurgh*. It is worth observing that only here Rustam is fighting his opponent with a bow. In the legend of Rustam as recorded in the *Shahname*, the hero uses the bow to fight Isfandyar. It is only because of the intervention of the *Simurgh* that Rustam is able to make an efficient arrow to be shot in the eyes of Isfandyar. In this way, two elements of the story of Rustam and Isfandyar could be present in the painting: the bow and, most importantly,



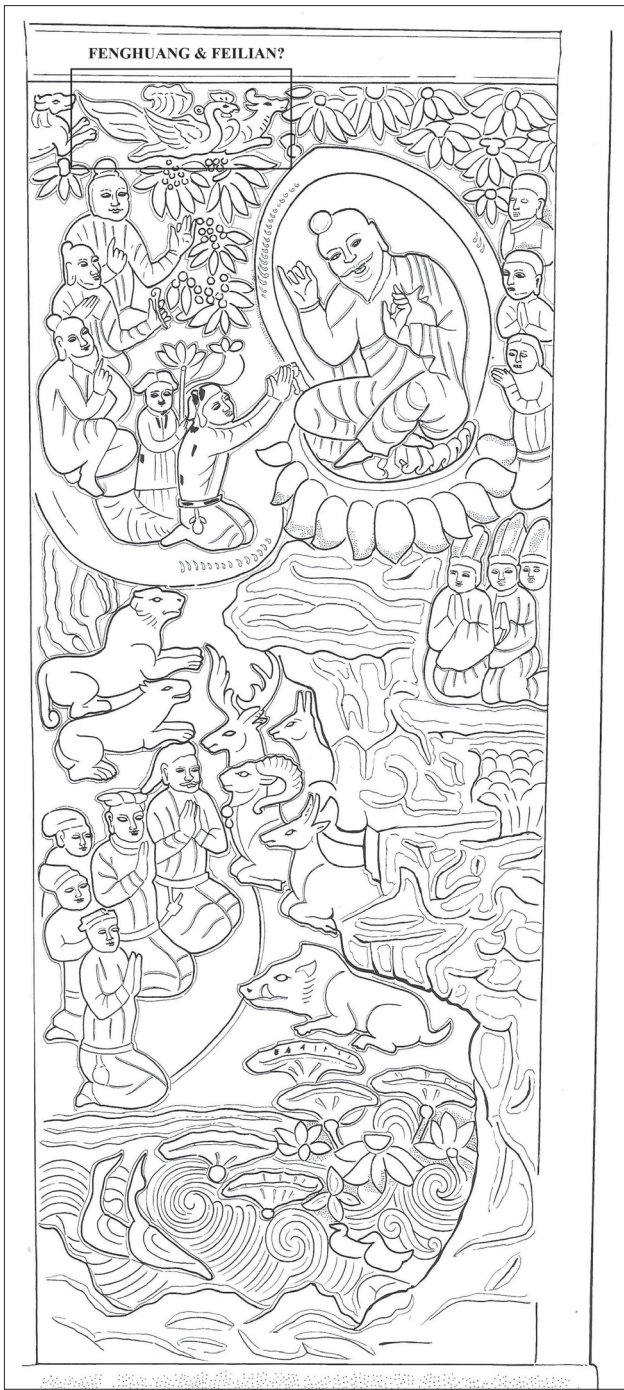

Figure 10. Line drawing of a panel from the Shi Jun sarcophagus (580) (Yang 2014, fig. 104)

the *Simurgh* that is on the contrary absent from the other scenes.<sup>20</sup> Once more, there would be enough evidence to confirm that, in Iranian art, the *Simurgh* has always been a bird, while the *Farr* (Sogdian *Farn*) has been represented in different ways, including various composite winged creatures (Compareti 2013b, pp. 25-28; Compareti 2015; Compareti forthcoming). Despite their chronological distance, my supposed 'Simurgh' from Penjikent strictly resembles the undeniable *Simurgh* represented in Inj'uid book illustrations that do not follow the Chinese style.

These observations could suggest a local Central Asia iconography for at least one kind of fantastic bird that existed independently of the Chinese *Fenghuang/Zhuniao* before the Islamisation of Iranian lands. Of course, it would be very interesting to find other traces of fantastic birds in Iranian art and consider which relations could exist between them and Chinese fantastic birds.

During the pre-Sui/Tang period, when China was fragmented in several dynasties ruling over small territories for short periods, many hybrid creatures were represented quite often in Chinese funerary art. In the Tang period they were going to be entirely substituted by the *Siling* or *Sishen* and, later, only the *Fenghuang* and the *Long* (usually translated as 'Dragon') were given great importance in Chinese art and culture. One of the sixth-century composite flying creatures is a bird with the hooves and head of a deer, although sometimes it looks like a dog, a horned horse, or other animal specimens. According to Chinese scholars, the name of this winged creature is *Feilian* and it should be associated with winged Iranian monsters such as the *Farr* (or pseudo-*Simurgh*).<sup>21</sup> In my opinion there is not enough evidence to decide on the matter. However, it is interesting to observe that a very similar flying hybrid animal is portrayed on one panel of the non-excavated Sino-Sogdian 'Vahid Kooros' funerary couch (fig. 8).<sup>22</sup>

As already noted above, Sino-Sogdian mortuary couches and sarcophagi represent a small group of unique funerary monuments executed by local artists for those high-ranking Sogdians who migrated into China in the

20 That of Isfandyar's trial is another very problematic story from the *Shahname*. In fact, Isfandyar was even able to kill the *Simurgh* with a trick. This image is often represented in Islamic book illustrations and it suggested to scholars that two *Simurgh* existed: a good one, i.e. the companion of Zal and Rustam, and a bad one that was killed by Isfandyar. Some other scholars prefer to consider the *Simurgh* to be ambivalent (Schmidt 1980a, pp. 18-19).

21 For the usual identification among Chinese scholars, see Sun 1996, pp. 164-175. According to other scholars, this fantastic creature is a *Qilin* (Girmond 1993, fig. 4-32, kat. 57).

22 The fantastic animal under examination here is described in the catalogue of the exhibition that followed the restoration of this funerary couch as an «Iranian *Senmurv*-like hybrid creature» (Riboud 2004, p. 20; see also Compareti 2007, fig. 1). Flying composite creatures, albeit not exactly like the one on the Vahid Kooros couch, can be observed on two more Sino-Sogdian monuments: the Yidu couch and the Shi Jun sarcophagus (Lerner 2013, fig. 7; Yang 2014, figs. 103-105; see fig. 10 in the present study).

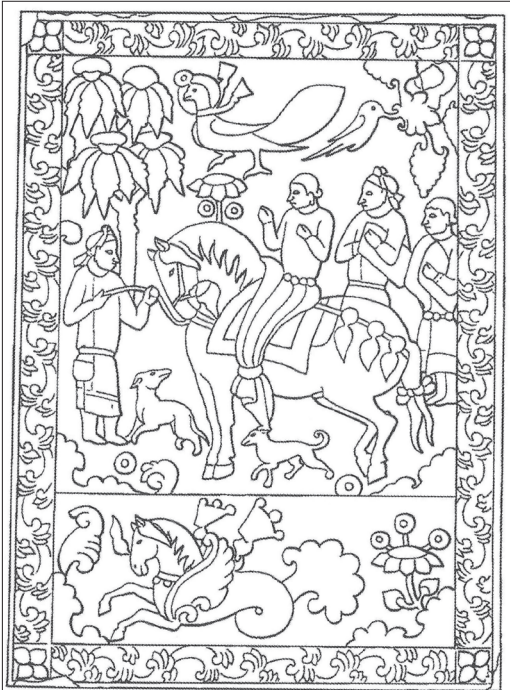

Figure 11. Detail of a panel from the Kang Ye funerary couch (ca. 571). The Xi'an Museum (Xi'an Municipal Institute of Archaeology and Preservation of Cultural Relics 2008, fig. 20)

Figure 12. Line drawing of a panel from Yu Hong sarcophagus (592 or 598). (Marshak 2001, 22b)



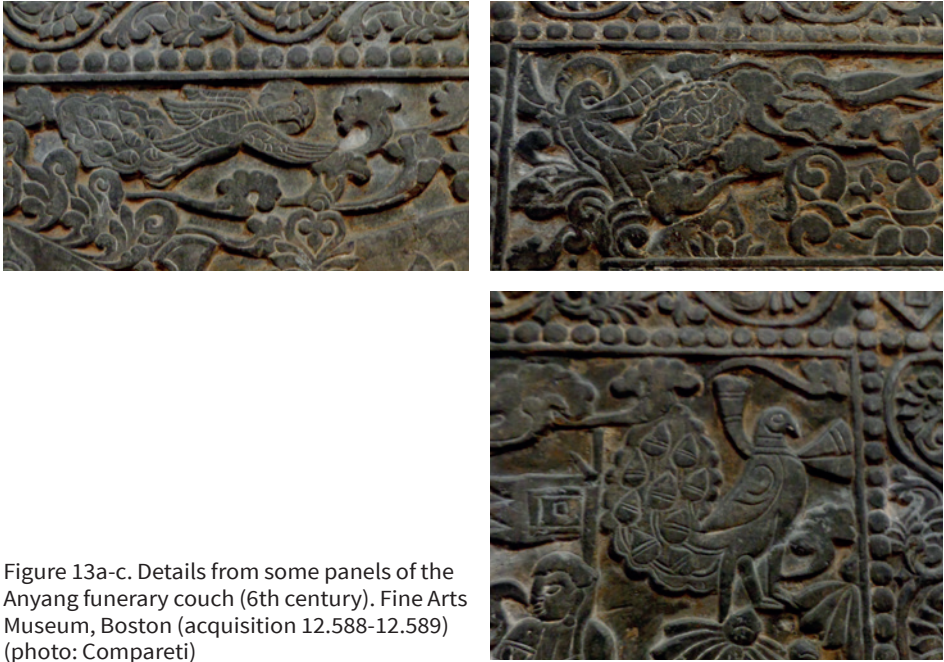

Figure 13a-c. Details from some panels of the Anyang funerary couch (6th century). Fine Arts Museum, Boston (acquisition 12.588-12.589) (photo: Compareti)

sixth century. Flying creatures like the *Feilian* are very enigmatic and it is very difficult to trace their origins. They were popular in a period of intense exchanges with Central Asia, India, and Persia but it is more probable that they are a Chinese creation since they do not appear anywhere else but inside the borders of modern China.<sup>23</sup>

In Sino-Sogdian funerary monuments many kind of birds are often represented. Sometimes they can be considered ordinary birds but, in most cases, they are portrayed with a halo, a necklace, and ribbons attached to their neck and with something in the beak. These are all characteristics of heavenly creatures in Iranian art; yet these birds could be regarded as animals of the royal park that, in any case, was a real paradise on earth for

23 Astronomical-astrological connections have been expressed by some authors for Chinese creatures connected with funeral art and directional animals: Juliano 1980, pp. 35-36. One tenth-eleventh century painting on silk copied from an original attributed to Zhang Sengyou (c. 490-540) and at present kept in the Osaka City Museum of Fine Arts represent the five planets and, among them, also Venus (*Taibai xing*) as a woman riding a *Fenghuang*: Masterpieces of Chinese Paintings 2013, 146. Sasanian seals and sealings present a vast range of hybrid creatures as decorative motifs but they do not exactly resemble the Chinese winged monster under examination. These Sasanian winged animals with horns probably have some astronomical-astrological connection, but it is only during the Islamic period that they had some diffusion in the arts (Compareti 2009-2010, pp. 30-31; Compareti 2014, pp. 23-25).



Figure 14. Detail of an early third century CE Roman capital reused in the church of Santi Felice e Regolo (founded in the 11th century), Pisa (photo: Compareti)



Figure 15. Details of the Sasanian rock reliefs Bishapur II (left) and Bishapur III (right) attributed to the time of Shapur I (240-272). Fars Province, Iran (photo: courtesy of Rudy Favaro)



Figure 16. Detail of a Sogdian painting from Penjikent, room 1 sector XXIV (ca. 740). St. Petersburg, the State Hermitage (photo: Compareti)

the king. In three cases, a bird is definitely a *Fenghuang/Zhuniao* according to the iconography of pre-Song art: on one panel of the Vahid Kooros couch (fig. 9);<sup>24</sup> on a panel in the Shi Jun sarcophagus (fig. 10) (Yang 2014, figs. 103-105); on the pedestal of the Kang Ye couch (fig. 11) (Xi'an Municipal Institute of Archaeology and Preservation of Cultural Relics 2008, fig. 20). Among the nine panels that embellish the sarcophagus of Yu Hong, only one does not display beribboned birds. Sometimes these birds hold something in the beak resembling a vegetal element. However, the most interesting bird of the Yu Hong sarcophagus is a beribboned peacock with a halo around its head: it is not really flying but, most precisely, floating in the air above a riderless horse (fig. 12).<sup>25</sup> It is worth observing that also in the non-excavated Anyang panels (today divided between three museums in France, Germany and USA), among the beribboned birds represented in several scenes, a sort of peacock too is portrayed at least three times: two with a halo and once without it (fig. 13) (Scaglia 1958, fig. 4).

Some other interesting composite creatures appear on the Yu Hong sarcophagus (and in other Sino-Sogdian monuments) showing clear bor-

24 In the catalogue of the Vahid Kooros couch, the fantastic bird is called 'Phoenix', while the other birds are considered to be connected with the Iranian concept of *Farr* (Riboud 2004, pp. 26, 31).

25 Marshak 2001, fig. 22.b. In his epitaph, Yu Hong does not present a name that in Chinese sources is usually associated with Sogdian family names. However, according to Yutaka Yoshida, his personal name, preserved only in Chinese, could be reconstructed as *Makh-farn* (glory of the god Makh, the Moon) in Sogdian (Kageyama 2007, p. 13 fn. 1).





Figure 17. Central part of the door from the tomb of Li Shou (d. 630). Shaanxi History Museum. (Asim 1993, p. 183)

rowings from Greco-Roman art, but they are not the focus of this study.<sup>26</sup> Also in the Yidu funerary monument almost every panel is embellished with a beribboned bird flying in the clouds, although none of them resembles the peacock-type observed in the Yu Hong and Anyang panels.

The peacock-type beribboned bird of those Sino-Sogdian funerary monuments had already called the attention of scholars. Marshak (2001, p. 254), for example, did not hesitate to identify that bird with the *Farr* or 'glory-charisma'.<sup>27</sup> In this way, a typical Iranian concept would have found its place among this group of monuments executed, in all probability, by Chinese artists. Some other typical Chinese elements had also been accepted by the Sogdians to be represented on their funerary monuments: not just the shape of the couch or sarcophagus but also the underground grave and some decorative elements (such as the riderless horse and the ox chariot) would point to a borrowing from Chinese traditions (Rawson 2001; Riboud 2003). How is it then possible to lay down a precise line of demarcation between what should be considered Iranian, Chinese, or, in some instances, Greco-Roman?

As it has been observed long ago, in Chinese funerary art fantastic birds appear quite often, especially during the Han period. In some scenes, these birds seem to fly in proximity of people who probably deserved special attention (fig. 1). In ancient Greek art something very similar can be observed as well: birds holding a beribboned ring or a simple disc in their beak approach people surely in order to exalt them. The Nike (Victory) that is usually represented as a small winged lady holding a laurel crown or other symbols of glory in the vicinity of a person should be considered in the same light (fig. 14).<sup>28</sup> A similar phenomenon can be observed also

---

26 Identifications of these creatures can be found in Marshak 2001, pp. 252-259. Strangely enough, on the pedestal of the northern side of Shi Jun sarcophagus, a mixture of Chinese and Iranian *Siling* can be observed while moving in the direction of a multi-armed central deity. Two symbolic creatures can be definitely identified as the *Baihu* (White Tiger) of the West and the *Qinglong* (Green Dragon) of the East. However, the two remaining ones have been substituted by an elephant on the left and a curious winged horse with a fishy coiled tail on the right. While the elephant could be associated to India and the South, the other hybrid creature can just be intended to represent a substitute for the *Xuanwu* (Dark Warrior) of the North (Yang 2014, figs. 120, 172-181). The iconography of the latter hybrid is definitely rooted in the image of the *Hippocampus* or *Ketos* of Greco-Roman art, although a typically Sasanian crescent on the head and ribbons have been added. This hybrid reminds another beribboned winged horse with a fishy tail observed twice in the panels of the Yu Hong sarcophagus (Marshak 2001, figs. 22.b-23; see fig. 12 in the present study). On some of the 'eastern' components of originally 'Western' fantastic creatures that would have been later accepted also in Iranian lands. See Favaro 2008; Scarzia 2008.

27 Another scholar made the same identification independently of Marshak (Zheng 2001, pp. 86-90).

28 The image that I have chosen to present in this study has been published several times. It is an early third-century Roman capital reused in the eleventh-century church of Santi



in pre-Islamic Iranian art of Persia and Central Asia. In a couple of Sasanian rock reliefs (Bishapur II and Bishapur III) and in some metal work (cautiously) considered to be Sasanian, a flying putto offers a diadem to the victorious king (fig. 15) (Vanden Berghe 1983, pp. 73-74, pls. 23-24) exactly like in Sogdian art angels, winged composite animals, and even a flying hand holding a beribboned ring can be represented in front of the person that should be exalted (fig. 16) (Azarpay 1975).

In the case of a Sogdian immigrant who was requesting a Chinese artist to create an appropriate tomb for him and his family, the image of a bird like a peacock embellished with ribbons and a halo could have satisfied both audiences, Iranian as well as Chinese. In the tomb of Li Shou, who died in 630, there is also a reproduction of a stone door embellished with a very interesting motif (Asim 1993, p. 183): two typical Tang (or, in any case, pre-Song) *Fenghuang/Zhuniao* are facing each other above the figures of two birds that could be easily identified as peacocks (fig. 17).<sup>29</sup> Despite the obvious Chinese identity of the tomb occupant, this early Tang grave displays several other elements imported from Iranian lands and the steppes in the funerary paintings such as the 'Parthian shot', the hunting scene, and the foreign attire of some individuals (Zhang 1995, figs. 1, 5). Some of the friezes show processions of women holding precious metal works; one of them – a rhyton – is definitely Iranian (Asim 1993, fig. 6-28, kat. 73.2).

So, which identification should be proposed for those fantastic birds? *Fenghuang/Zhuniao* or *Simurgh* or *Farr*? It is not easy to give a precise answer to this question. As I have tried to prove in another study, the presence of a fantastic bird in a typical Iranian work of art such as the sixth-century Merv painted vase could offer a very interesting term of comparison for many scenes of Sino-Sogdian monuments (Compareti 2011). However, it is extremely difficult to decide on a precise identification for that specific bird that could very easily be the *Simurgh* or just a manifestation of the *Farr* or even the *Homa*, 'the bird of royal glory'. Since the *Simurgh* was represented only as a bird and the *Farr* could be *also* a bird (especially in Central Asia), some confusion at an iconographic level could also have affected the most acculturated Iranian observer. From the point

Felice e Regolo, Pisa. It features a unique decoration of Olympian deities with a Nike flying next to them and presenting a ring as symbol of glory (Tedeschi Grisanti 1992). Elements like the glorifying bird with a ring in the beak or the winged Nike were borrowed by other peoples in contact with Greek art and culture. Not just the Romans, who were the direct heirs of the Greek experience, but also other Iranian Hellenized people such as the Parthians knew these symbols very well and adopted them in their coinage (Sinisi 2008; Vardanyan 2001, figs. 3.11-12, 11.2, 4, 6, 14.9). A not well-preserved Nike can be observed also in a first-century BCE Parthian rock relief at Bisutun (Vanden Berghe 1983, p. 45, fig. 3).

<sup>29</sup> A very similar scene with a yellow Phoenix identified by an inscription and two peacocks facing one another appears in the already mentioned Euxinus' inn painting (Archaeological Deposits inv. 41761) (see Zambon 2004, p. 19).

of view of a Sogdian high rank official who wanted to appear as much sinicized as possible, the presence of one or more (Iranian) fantastic birds among the decorations of his funerary monument could have been easily understood as an auspicious symbol also in the sphere of Chinese art and culture of that period (6th century).

Despite the problem of 'Western' (that is to say Greco-Roman) iconographic borrowings that can be detected in Sasanian and Sogdian art, it is clear that all these flying (or, sometimes, floating) creatures are just a way to represent auspicious symbols of divine protection or approval that should be considered universal and easy to understand in every cultural milieu. In the case of the fantastic bird such a mechanism of adoption and adaptation could have moved very easily from one cultural milieu to another, since everywhere there was a cosmic bird associated with good fortune, immortality, and funerary rituals. It is normal to expect also iconographic exchanges, especially in the period between the sixth and the seventh centuries, when all the regions interested in the caravan trade (from the Mediterranean Sea to China, passing through Persia and Central Asia) were experiencing an exceptionally favourable period of receptivity and search for every kind of exoticism and luxury objects.

## Bibliography

- Alabasio, Alida (1994). «La Fenice». In: Lucidi, Maria Teresa (a cura di), *La seta e la sua via = Catalogo della mostra* (Roma, 23 gennaio-10 aprile 1994). Roma: De Luca, pp. 163-165.
- Álvarez-Pedrosa, Juan Antonio (2014). «The Reconstruction of the Pre-Christian Slavic Religion and Iranian Lexical Borrowing: A Methodological Review». *Ollodagos*, 30, pp. 61-80.
- Amad, Gladys (1988). *Recherches sur le mythe du phénix dans la mosaïque antique*. Montevideo: s.n.
- Asim, Ina (1993). «Die aristokratische Graubkultur des 7. und 8. Jahrhunderts». In: Kuhn, Dieter (Hrsg.), *Chinas Goldenes Zeitalter: Die Tang-Dynastie (618-907 n. Chr.) und das Kulturelle Erbe der Seidenstraße*. Heidelberg: Braus, pp. 173-219.
- Azarpay, Guitty (1975). «Some Iranian Iconographic Formulae in Sogdian Painting». *Iranica Antiqua*, 11, pp. 168-177.
- Azarpay, Guitty (1981). *Sogdian Painting: The Pictorial Epic in Oriental Art*. Berkeley; Los Angeles; London: University of California Press.
- Berthier, François (2001). «Le Phénix rouge de la tombe Kitora (Japon)». *Arts Asiatiques*, 58, pp. 147-148.
- Birrell, Anne (1999). *The Classic of Mountains and Seas*. London: Penguin.
- Bivar, David (2009). «The Rukhkh, Giant Eagle of the Southern Seas». In: Sundermann Werner; Hintze, Almut; de Blois, François (eds.), *Exegisti*

- Monumenta: Festschrift in Honour of Nicholas Sims-Williams*. Wiesbaden: Harrassowitz, pp. 1-12.
- Boyce, Mary (1975). *A History of Zoroastrianism: I*. Leiden; Köln: Brill.
- Boyce, Mary (1983). «Adur Farnbag» s.v. [online]. *Encyclopaedia Iranica*, 1 (5), pp. 473-475. Available at <http://www.iranicaonline.org/articles/adur-farnbag-an-atas-bahram-see-atas-that-is-a-zoroastrian-sacred-fire-of-the-highest-grade-held-to-be-one-of-the> (2015-12-01).
- Canepa, Matthew (2014). «Textiles and Elite Tastes between the Mediterranean, Persia and Asia at the End of Antiquity». In: Nosch, Marie-Luise; Zhao, Feng; Varadarajan, Lotika (eds.), *Global Textile Encounters*. Oxford; Philadelphia: Oxbow, pp. 1-14.
- Charritat, Maguy (2001). «Le senmurv». En: Taylor, Marthe Bernus (éd.), *L'Étrange et le Merveilleux en terres d'Islam = Catalogue de l'exposition* (Paris, 23 avril-23 juillet 2001). Paris: Réunion des Musées Nationaux, p. 117.
- Company, Robert Ford (2000). «R. Fracasso, *Libro dei Monti e dei Mari (Shanghai Jing): Cosmografia e mitologia nella Cina antica*. Venezia, 1996 and A. Birrell, *The Classic of Mountains and Seas*. London, 1999» [Reviews]. *Journal of Chinese Religions*, 28, pp. 177-187.
- Compareti, Matteo (2005). «Sasanian Textile Art: An Iconographic Approach». *Studies on Persianate Societies*, 3, pp. 143-163.
- Compareti, Matteo (2006). «The So-Called *Senmurv* in Iranian Art: A Reconsideration of an Old Theory». In: Borbone, Pier Giorgio; Mengozzi, Alessandro; Tosco, Mauro (eds.), *Loquentes linguis: Linguistic and Oriental Studies in Honour of Fabrizio A. Pennacchiotti*. Wiesbaden: Harrassowitz, pp. 185-200.
- Compareti, Matteo (2007). «Remarks on the Monstrous Flying Creature in a Northern Dynasty Period Funerary Couch belonged to a Sogdian». In: Zhang, Qingjie; Li, Shuji; Li, Gang (eds.), *The Eurasian Continent and Northern China during the 4th-6th Centuries*. Beijing: Kexue Chubanshe, pp. 166-189 (in Chinese).
- Compareti, Matteo (2009). *Samarqanda centro del mondo: Proposte di lettura del ciclo pittorico di Afrāsyāb*. Milano; Udine: Mimesis.
- Compareti, Matteo (2009-2010). «'Holy Animals' of Mazdeism in Iranian Arts: Ram, Eagle and Dog». *Nāme-ye Irān-e Bāstān*, 17-18, pp. 27-42.
- Compareti, Matteo (2011). «The Painted Vase of Merv in the Context of Central Asian Pre-Islamic Funerary Tradition». *The Silk Road*, 9, pp. 26-41.
- Compareti, Matteo (2013a). «Sogdiana and the 'Others': Specimens of External Borrowings in Pre-Islamic Sogdian Art». In: Espagne, Michel; Mustafaev, Shahin; Gorshenina, Svetlana; Rapin, Claude; Grenet, Frantz; Karev, Yuri (eds.), *Cultural Transfers in Central Asia: Before, During and After the Silk Road*. Samarkand: Micai, pp. 74-79.

- Compareti, Matteo (2013b). «Due tessuti centrasiatrici cosiddetti 'zandaniji' decorati con pseudo-*Simurgh*». In: Compareti, Matteo; Favaro Rudy (a cura di), *Le spigolature dell'Onagro: Miscellanea composta per Gianroberto Scarcia in occasione dei suoi ottant'anni*. Venezia, pp. 17-37.
- Compareti, Matteo (2014). «Teratologia fantastica in Subcaucasia: La migrazione di motivi decorativi tra l'Iran e il Caucaso». In: Ferrari, Aldo; Guizzo, Daniele (a cura di), *Al crocevia delle civiltà: Ricerche su Caucaso e Asia Centrale*. Venezia: Edizioni Ca' Foscari, pp. 11-50.
- Compareti, Matteo (2015). «Ancient Iranian Decorative Textiles: New Evidence from Archaeological Investigations and Private Collections». *The Silk Road*, 13, pp. 36-44.
- Compareti, Matteo (forthcoming). «*Simurgh* or *Farr*? On the Representation of Fantastic Creatures in the Sogdian 'Rustam Cycle' at Penjikent». *Journal of the Inner Asian Art and Archaeology*, 12.
- Compareti, Matteo; Cristoforetti, Simone (2012). «Il fumo iranico della pipa di Perm». In: Ciure, Florina; Nosilia, Viviana; Pavan, Adriano (a cura di), *Multa et Varia: Studi offerti a Maria Marcella Ferraccioli e Gianfranco Giraud*. Milano: Biblion, pp. 239-250.
- Compareti, Matteo; Scarcia, Gianroberto (2012). «Zone d'ombra nell'Est iranico alla vigilia dell'islamizzazione». *Parthica*, 14, pp. 207-254.
- Cristoforetti, Simone (unpublished). «Ashik Kerib: menestrelli sul limes». Paper read at the conference *Musica e cultura persiana nel mondo ottomano* (Venezia, 1 aprile 2014).
- Cristoforetti, Simone; Scarcia, Gianroberto (2013). «Talking about *Simurǵ* and *Ṭāq-i Bustān* with Boris I. Marshak». In: Pavel B. Lurje; Asan I. Torgoev (eds.), *Sogdians, Their Precursors, Contemporaries and Heirs = Proceedings of the International Conference «Sogdians at Home and Abroad» Held in memory of Boris Il'ich Marshak (1933-2006)*. Saint Petersburg: The State Hermitage Publishers, pp. 339-352.
- Curatola, Giovanni (1978). «Il 'Vishap' di Aght'amar: nota sulla diffusione occidentale di un motivo iconografico». *Oriente Moderno*, 7-8, pp. 285-302.
- Curatola, Giovanni (1989). *Draghi: La tradizione artistica orientale e i disegni del tesoro del Topkapı*. Venezia: Poligrafo.
- de La Vaissière, Étienne (2005). *Sogdian Traders: A History*. Leiden; Boston: Brill.
- Diény, Jean-Pierre (1989-1990). «Le Fenghuang et le Phénix». *Cahiers d'Extrême-Asie*, 5, pp. 1-13.
- Dulaey, Martine (2013). «Le phénix dans l'iconographie des premiers siècles chrétiens». En: Grosserez, Laurence (éd.), *Le Phénix et son autre: Poétique d'un mythe (des origines au XVIe siècle)*. Rennes: Presses Universitaires de Rennes, pp. 91-118.
- Erickson, Susan (2011). «The Han Dynasty Que Pillars of the Central Marchmount Mt. Song in Henan Province». *Oriental Art*, 50 (5), pp. 2-17.

- Fracasso, Riccardo (1996). *Libro dei Monti e dei Mari (Shanghai Jing): Cosmografia e mitologia nella Cina antica*. Venezia: Marsilio.
- Favaro, Rudy (2008). «Teratologia abissale ai confini del mondo». In: Revelli, Giorgetta (a cura di), *Da Ulisse a... Il viaggio negli abissi marini tra immaginazione e realtà*. Pisa: ETS, pp. 121-133.
- Gadjiev, Murtazali (2006). «Interpretation of a Bronze Figurine of Warrior from Gigat' (Daghestan)». In: Compareti, Matteo; Raffetta, Paola; Scarcia, Gianroberto (eds.), *Ērān ud Anērān = Studies Presented to B. I. Maršak on the Occasion of His 70th Birthday*. Venezia: Cafoscarina, pp. 199-212.
- Girmond, Sybille (1993). «Die Entfaltung der Pracht im Alltag». In: Kuhn, Dieter (Hrsg.), *Chinas Goldenes Zeitalter: Die Tang-Dynastie (618-907 n. Chr.) und das Kulturelle Erbe der Seidenstraße*. Heidelberg: Braus, pp. 110-155.
- Grenet, Frantz (2005). «The Self-Image of the Sogdians». En: de La Vaisière, Étienne; Trombert, Éric (éds.), *Les Sogdiens en Chine*. Paris: École française d'Extrême-Orient, pp. 123-40.
- Grenet, Frantz (2012). «Yima en Bactraîne et en Sogdiane: nouveaux documents». En: Azarnouche, Sharma; Redard Céline (éds.), *Yama/Yima: Variations indo-iraniennes sur la geste mythique*. Paris: De Boccard, pp. 83-94.
- Grossato, Alessandro (2004). «La fenice in Oriente». In: Zambon, Francesco; Grossato, Alessandro (a cura di), *Il mito della fenice in Oriente e in Occidente*. Venezia: Marsilio, pp. 82-173.
- Grosserez, Laurence (2013). «Le phénix, le temps et l'éternité». En: Grosserez, Laurence (éd.), *Le Phénix et son autre: Poétique d'un mythe (des origines au XVIIe siècle)*. Rennes: Presses Universitaires de Rennes, pp. 21-45.
- Grube, Ernst (1978). «Persian Painting in the Fourteenth Century: A Research Report». *Annali dell'Istituto Orientale di Napoli*, 17 (38). 4. Supplemento.
- Gyselen, Rika (2010). «'Umayyad' Zāvulistān and Arachosia: Copper Coinage and the Sasanian Monetary Heritage». In: Alram, Michael; Klimburg-Salter, Deborah; Inaba, Minoru; Pfisterer, Matthias (eds.), *Coins, Art and Chronology II: The First Milenium CE In the Indo-Iranian Borderlands*. Wien: Verlag der Österreichischen Akademie der Wissenschaften, pp. 219-241.
- Hackin, Joseph (1939). *Researches archéologiques à Begram*. Paris: Les éditions d'art et d'histoire.
- Jeon, Ho-tae (2005). «Documenting the Dreams of the Living and Hopes of the Dead: Goguryeo (Koguryo) Tomb Murals». In: Jeon, Ho-tae; Choi, Jong-taik (eds.), *Art of Ancient Korea*. Seoul: The Korea Foundation, pp. 164-193.

- Juliano, Annette (1980). *Teng-Hsien: An Important Six Dynasties Tomb*. Ascona: Artibus Asiae Publisher. Supplementum, vol. 37.
- Kageyama, Etsuko (2007). «The Winged Crown and the Triple-Crescent Crown in the Sogdian Funerary Monuments from China: Their Relation to the Hephtalite Occupation of Central Asia». *Journal of Inner Asian Art and Archaeology*, 2, pp. 9-20.
- Leclerc, Annick Neveux (2001). «Le Simurgh». En: Taylor, Marthe Bernus (éd.), *L'Etrange et le Merveilleux en terres d'Islam = Catalogue de l'exposition* (Paris, 23 avril-23 juillet 2001). Paris, p. 120.
- Lerner, Judith (2005). *Aspects of Assimilation: The Funerary Practices and Furnishing of Central Asians in China*. *Sino-Platonic Papers*, 168.
- Lerner, Judith (2013). «Yidu: A Sino-Sogdian Tomb?». In: Lurje, Pavel; Torgoev, Asan (eds.), *Sogdians, Their Precursors, Contemporaries and Heirs = Proceedings of the International Conference «Sogdians at Home and Abroad» Held in memory of Boris Il'ich Marshak (1933-2006)*. Saint Petersburg: The State Hermitage Publishers, pp. 129-146.
- Liu, Xingzhen; Yue, Fengxia (1991). *Han Dynasty Stone Reliefs: The Wu Family Shrines in Shandong Province*. Beijing: Foreign Languages Press.
- Lo Muzio, Ciro (2003). «La scena di caccia dalla necropoli di Kopeny (Minusinsk)». In: Fontana, Maria Vittoria; Genito, Bruno (a cura di), *Studi in onore di Umberto Scerrato per il suo settantacinquesimo compleanno*. Napoli: Università degli Studi di Napoli «L'Orientale»; Roma: Istituto Italiano per l'Africa e l'Oriente, pp. 519-538.
- Loewe, Michael (1979). *Ways to Paradise: The Chinese Quest for Immortality*. London: George Allen & Unwin.
- Marshak, Boris (2001). «La thématique sogdienne dans l'art de la Chine de la seconde moitié du VI<sup>e</sup> siècle». *Comptes Rendus de l'Académie des Inscriptions et Belles-Lettres*, 1, pp. 227-264.
- Marshak, Boris (2002). *Legends, Tales, and Fables in the Art of Sogdiana*. New York: Bibliotheca Persica Press.
- Marshak, Boris (2004). «The Miho Couch and Other Sino-Sogdian Works of Art of the Second Half of the 6th Century». *Miho Museum*, 4, pp. 16-31.
- Masterpieces (2013). *Masterpieces of Chinese Paintings 700 to 1900*. London: Victoria and Albert Museum Publishing.
- Melikoff, Irène (1962). *Abū Muslim: Le 'porte-hache' du Khorassan dans la tradition épique turco-iranienne*. Paris: Maison-neuve.
- Miquel, André (1980). *La géographie humaine du monde musulman jusqu'au milieu du XI<sup>e</sup> siècle: Le milieu naturel*. Paris; La Haye; New York: Mouton.
- Miquel, André (1988). *La géographie humaine du monde musulman jusqu'au milieu du XI<sup>e</sup> siècle: Les travaux et les jours*. Paris: Éditions de l'EHESS.
- Mode, Markus (2006). «Art and Ideology at Taq-i Bustan: The Armoured Equestrian». In: Mode, Markus; Tubach, Jurgen (eds.), *Arms and Armours as Indicators of Cultural Transfer: The Steppes and the Ancient*



- World from Hellenistic Times to the Early Middle Ages*. Wiesbaden: Harrassowitz, pp. 393-413.
- Noja, Sergio (1983). «Les chevaux ailés de 'Ā'īšah – Dieu soit satisfait avec elle – et les *banāt*». *Annali dell'Istituto Orientale di Napoli*, 43 (1), pp. 33-42.
- Pirazzoli-t'Serstevens, Michèle (1982). *The Han Dynasty*. New York: Rizzoli.
- Rawson, Jessica (1984). *Chinese Ornament: The Lotus and the Dragon*. London: British Museum Publications Limited.
- Rawson, Jessica (2001). «Creating Universes: Cultural Exchange as Seen in Tombs in Northern China between the Han and Tang Periods». In: Wu, Hung (ed.), *Between Han and Tang: Cultural and artistic Interaction in a Transformative Period*. Beijing: Wenwu Chubanshe, pp. 113-152.
- Redard, Céline (2012). «L'oiseau Karšiptar (V. 2.42)». En: Azarnouche, Sharna; Redard, Céline (éds.), *Yama/Yima: Variations indo-iraniennes sur la geste mythique*. Paris: De Boccard, pp. 193-205.
- Riboud, Pénélope (2003). «Le cheval sans cavalier dans l'art funéraire sogdien en Chine: à la recherche des sources d'un thème composite». *Arts Asiatiques*, 58, pp. 148-161.
- Riboud, Pénélope (2004). «Description du monument». En: *Lit de pierre, sommeil barbare: Présentation, après restauration et remontage, d'une banquette funéraire ayant appartenu à un aristocrate d'Asie centrale venu s'établir en Chine au VI<sup>e</sup> siècle*. Paris: Musée Guimet, pp. 15-31.
- Russell, James (1987). *Zoroastrianism in Armenia*. Harvard: Harvard University.
- Salviati, Filippo (1994). «La fenice nell'archeologia cinese». In: Lucidi, Maria Teresa (a cura di), *La seta e la sua via = Catalogo della mostra* (Roma, 23 Gennaio-10 Aprile 1994). Roma: De Luca, p. 5.
- Scaglia, Giustina (1958). «Central Asians on a Northern Ch'i Gate Shrine». *Artibus Asiae*, 21 (1), pp. 9-28.
- Scarcia, Gianroberto (1985). «Bahr-i ahzar, Muhīt-i islāmī». In: Sarnelli Cerqua, Clelia (a cura di), *Studi arabo-islamici in onore di Roberto Rubinacci nel suo settantesimo compleanno*. Napoli: Istituto Universitario Orientale, pp. 583-592.
- Scarcia, Gianroberto (2003). «Sulla Fenice dei Baluci». In: Compareti, Matteo; Scarcia, Gianroberto (a cura di), *Il falcone di Bistam: Intorno all'iranica Fenice/Samand: un progetto di sintesi per il volo del Pegaso iranico tra Ponto, Alessandretta e Insulindia*. Venezia: Cafoscarina, pp. 7-26.
- Scarcia, Gianroberto (2008). «Le ali dei pesci». In: Revelli, Giorgetta (a cura di), *Da Ulisse a... Il viaggio negli abissi marini tra immaginazione e realtà*. Pisa: ETS, pp. 135-140.
- Scarcia, Gianroberto; Vercellin, Giorgio (1970). «Leucippidi e Dioscuri in Iran». *Annali di Ca' Foscari*, 9 (3), pp. 39-62.



- Schafer, Edward (1963). *The Golden Peaches of Samarkand: A Study of T'ang Exotics*. Berkeley, Los Angeles: University of California Press.
- Schmidt, Hans Peter (1980a). «The Sēnmurw. Of Birds and Dogs and Bats». *Persica*, 9, pp. 1-85.
- Schmidt, Hans Peter (1980b). «The Sīmurgh in Sasanian Art and Literature». *Journal of the K.R. Cama Oriental Institute*, 48, pp. 161-178.
- Schmitz, Barbara (1997). *Islamic and Indian Manuscripts and Paintings in the Pierpont Morgan Library*. New York: The Pierpont Morgan Library.
- Shenkar, Michael (2014). *Intangible Spirits and Graven Images: The Iconography of Deities in the Pre-Islamic Iranian World*. Leiden; Boston: Brill.
- Sinisi, Fabrizio (2008). «Tyche in Parthia: The Image of the Goddess on Ar-sacid Tethradrachms». *Numismatische Zeitschrift*, 116-117, pp. 231-248.
- Stchoukine, Ivan (1966). *La peinture turque d'après les manuscrits illustrés. 1er partie de Sulaymān Ier à 'Osmān II (1520-1622)*. Paris: Librairie Orientaliste Paul Geuthner.
- Sun, Ji (1996). *The Holy Fire of China: Some Problems about East-West Cultural Interchange and Ancient Chinese Civilization*. Shenyang: Liaoning Jiaoyu Chubanshe (in Chinese).
- Swietochowski, Maria Luce; Carboni, Stefano (1994). *Illustrated Poetry and Epic Images: Persian Paintings of the 1330s and 1340s*. New York: The Metropolitan Museum of Art.
- Tanabe, Katsumi (2006). «The Identification of the King of Kings in the Upper Register of the Larger Grotte, Taq-i Bustan: Ardashir III Restated». In: Compareti, Matteo; Raffetta, Paola; Scarcia, Gianroberto (eds.), *Ērān ud Anērān = Studies Presented to B.I. Maršak on the Occasion of His 70th Birthday*. Venezia: Cafoscarina, pp. 583-601.
- Tedeschi Grisanti, Giovanna (1992). «Capitelli romani figurati a Pisa». In: Settis, Salvatore (a cura di), *'Capitelli di mitologia': Da un tempio romano alla chiesa di San Felice in Pisa: Un reimpiego e un restauro*. Pisa: Cassa di Risparmio di Pisa, pp. 47-69.
- Trever, Camilla (2005). «The Dog-Bird: Senmurv = Paskuj». In: Daneshvari, Abbas, Glucks, Jay (eds.), *A Survey of Persian Art from Prehistoric Times to the Present, XVII: Prehistoric Times to the End of the Sasanian Empire*. Costa Mesa (CA): Mazda Publishers, pp. 161-175.
- Tuplin, Christofer (1992). «The Persian Bird: An Ornithonymic Conundrum». *Archäologische Mitteilungen aus Iran*, 25, pp. 125-129.
- Turfan Museum (1992). *Turfan Museum*. Urumqi: Xinjiang Fine Arts and Photo Publishing House.
- Van den Broek, Roelof (1972). *The Myth of the Phoenix, According to Classical and Early Christian Traditions*. Leiden: Brill.
- Vanden Berghe, Luis (1983). *Reliefs rupestres de l'Irān ancien*. Bruxelles: Musées Royaux d'art et d'histoire.

- Vardanyan, Ruben (2001). «Tendenze culturali e ideologiche nell'impero partico riflesse dalla monetazione». *Parthica*, 3, pp. 25-132.
- Vernant, Jean-Pierre (2013). *La morte negli occhi: Figure dell'Altro nell'antica Grecia*. Bologna: il Mulino. Trad. di: *La mort dans les yeux*. Paris: Hachette, 1985.
- Walker, Alicia (2008). «Patterns of Flight: Middle Byzantine Adoptions of the Chinese *Feng-Huang* Bird». *Ars Orientalis*, 38, pp. 189-216.
- Walker, Alicia (2012). *The Emperor and the World: Exotic Elements and the Imaging of Middle Byzantine Imperial Power, Ninth to Thirteenth Centuries CE*. New York: Cambridge University Press.
- Whitfield, Roderick; Farrer, Anne (1990). *Caves of the Thousand Buddhas: Chinese Art from the Silk Road*. London: British Museum Publications.
- Willems, William (1965). *Origini dell'arte cinese*. Milano: Silvana. Trad. di: *Chinese Art*. London: Penguin, 1958.
- Wong Pui Yin, Marianne (2006). «Power of Image: A Study of the *Siling* Combinations in Han Tomb Interior». *The Study of Art History*, 8, pp. 163-198.
- Wu, Hung (1989). *The Wu Liang Shrine: The Ideology of Early Chinese Pictorial Art*. Stanford: Stanford University Press.
- Xi'an Municipal Institute of Archaeology and Preservation of Cultural Relics (2008). «Tomb of Kang Ye of the Northern Zhou in Xi'an, Shaanxi». *Wenwu*, 6, pp. 14-35 (in Chinese).
- Yang, Junkai (2014). *Shi Jun Tomb of the Northern Zhou Dynasty*. Beijing: Wenwu Chubanshe (in Chinese).
- Zakharia, Katia (2002). «La 'anqâ'. Quelle place pour le phénix dans le monde arabo-musulman classique?» En: Fabrizio-Costa, Silvia (éd.), *Le Phénix, mythe(s) et signe(s) = Actes de colloque international organisé à Caen par le Laboratoire d'Etudes Italiennes, Ibériques et Ibéro-Américaines (LEIA)*. Caen: Peter Lang, pp. 116-138.
- Zambon, Francesco (2004). «La fenice in Occidente». In: Zambon, Francesco; Grossato, Alessandro (a cura di), *Il mito della fenice in Oriente e in Occidente*. Venezia: Marsilio, pp. 15-81.
- Zhang, Hongxiu (1995). *A Collection of China's Tang Dynasty Frescoes*. Shenzhen: Lingnan Art Publishing House.
- Zheng, Yan (2001). «Northern Qi Pictorial Carvings from Qingzhou and Sinicized Sogdian Art: An Observation Inspired by the Yu Hong Sarcophagus and Other New Archaeological Finds». In: Wu, Hung (ed.), *Between Han and Tang: Cultural and artistic Interaction in a Transformative Period*. Beijing: Wenwu Chubanshe, pp. 73-109 (in Chinese).



## Borders

Itineraries on the Edges of Iran

edited by Stefano Pellò

## Vague Traits

# Strategy and Ambiguities in the Decorative Programme of the Aḥmad Šāh I Bahmanī Mausoleum

Sara Mondini

(Università Ca' Foscari Venezia, Italia)

**Abstract** The essay reconsiders the decorative programme of the Aḥmad Šāh I Bahmanī (r. 1422-1436) mausoleum in Ashtur (Bidar, modern Karnataka) focusing, in particular, on the inscriptions adorning the dome. The reign of the ninth Bahmanī sovereign was marked by a growing complexity as far as the socio-political and religious context is concerned, and also, by a deepening divide between *āfāqīs* and *dakhnīs*, and the arrival of the first exponents of the Ni'matullāhiyya Sufi order in the Deccan. The region witnessed a marked interplay between temporal and spiritual power, and the religious orientation of Aḥmad Šāh I remains debated. By making some specific remarks concerning the decorative scheme and the epigraphic programme of the mausoleum, we not only discuss the idea of the king's adherence to Shi'a Islam, but also provide valid support for historians wishing to reconsider the process of Shi'ization of Deccan and of the Sufi order itself.

**Keywords** Bahmanī. Deccan. Funerary architecture. Religious identity. Shi'a. Ni'matullāhiyya.

In a recently published work (Mondini 2015) I have sought to trace the evolution of the perception of the mausoleum dedicated to Aḥmad Šāh I (r. 1422-1436), the ninth sovereign of the Bahmanī dynasty (1347-1527), who was responsible – according to the sources – for establishing the Ni'matullāhiyya order in the Deccan. While that contribution focused on the modern sharing of the structure by members of different faiths, on its frequentation and veneration, I now wish to examine its decorative scheme and the political and religious discourse it inherently promotes. For this purpose, I will start with some considerations that emerged during the conference *Shi'i Spirituality and Sufi Paths in Early and Modern Times*, held at Ca' Foscari University, Venice, 2014.<sup>1</sup> Among other topics, participants discussed the Ni'matullāhiyya order and its development in the Indian Subcontinent.

Despite the widespread idea of what could be defined as a 'late

---

**1** Conference *Shi'i Spirituality and Sufi Paths in Early and Modern Times*, held at Ca' Foscari University of Venice, on the 15 April 2014, and organized by Denis Hermann (CNRS, Mondes Iranien et Indien, Paris), Marco Salati (Ca' Foscari University of Venice) and Mathieu Terrier (EPHE, Paris).

Shi'ization' of the Deccani branch of the *tariqa*, in my opinion the issue of the religious orientation of the sovereign – and indirectly of his relation with the firsts Deccani exponents of the order – remains open. I am convinced that some remarks concerning the decorative scheme of the mausoleum could constitute a valid support for historians – including religious historians – wishing to reconsider the issue and the Shi'ization process of the region, as well as of the order.

As rightly stated by Speziale in his paper at the above-mentioned conference and in his article (2013, pp. 92-93; 2014), soon after the foundation of the Ni'matullāhiyya in Iran, the Deccani region became the crucial setting for the development of the order over the following four centuries. For a better understanding of the spread and phases of development of the brotherhood, its 'Indian history' must be divided into two main periods: in the first, Bidar – then the capital of the Bahmanī Kingdom and today in the modern state of Karnataka – served as main centre, while in the second period, which roughly began in the mid-seventeenth century, the order moved to the Hyderabad area, in the modern state of Telengana (Speziale 2013, pp. 92-94).

Studies on Deccan history, religion, and art have shown how in the region the issue of sovereigns' adherence to Shi'a Islam, and of the Shi'ization of orders – as is the case of the Ni'matullāhiyya – before the seventeenth century, is no small matter (Haig 1924, pp. 73-80; Rizvi 1986, pp. 251-256; Siddiqi 1989, pp. 78-85). This was a complicated phase from a socio-political and religious point of view, where we witness a marked interplay between temporal and spiritual power, here embodied by the numerous Sufi brotherhoods. At the same time, the power of what had emerged as a firm Sunni majority (whose members are known as *dakhnīs* or *mulkīs*), appears to have been affected by the emergence of a new class of immigrants coming from central Asia (*āfāqīs* or *ghayr-mulkīs*), increasingly of Shi'i orientation. This complexity, which has been analysed in various works (Sherwani 1985; Coslovi 1990; Khalidi 1990; Sherwani 1990; Eaton 2008), does not appear to be completely elucidated by the inaccurate (or unreliable) sources we have,<sup>2</sup> making it difficult to reconstruct both the religious view of the members of the main dynasties and the orientation of some religious orders, as well as to trace any doctrinal shift.

However, in this morass of gaps that are still waiting to be bridged, historians can sometimes find support in artistic and architectural evidence. Fortunately, in recent decades the Deccani heritage has attracted the attention

---

2 On the sources concerning the Ni'matullāhiyya see Speziale (2013, pp. 95-96). On the sources concerning the history of the Bahmanī dynasty a good overview was offered by Fischel on the occasion of the Simon Digby Memorial Conference (Fischel 2014). What remains emblematic, for instance, is the negative opinion on Firishta, one of the main sources we have on Bahmanī history (Hardy 1977, pp. 943-945).

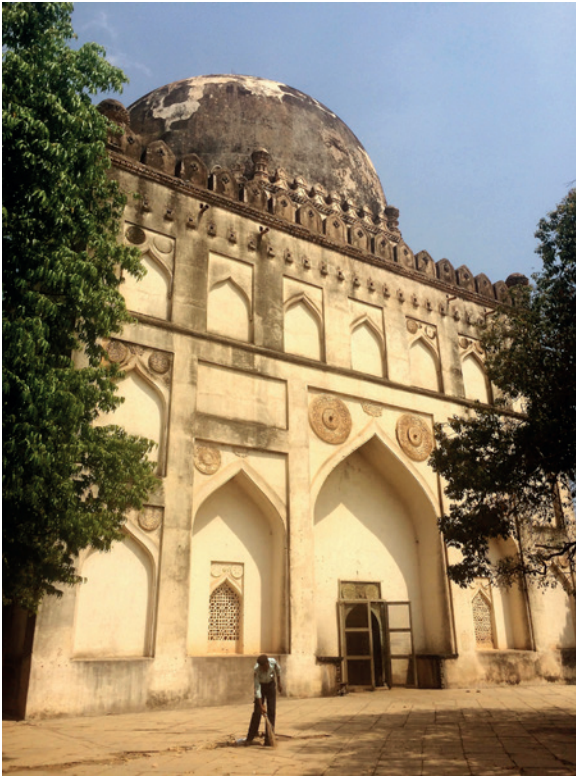

Figure 1. The mausoleum of Aḥmad Šāh I Bahmanī, exterior (photo: Mondini, 2015)

of art historians; but despite the high quality of recent research,<sup>3</sup> because of the amount of monuments and their state of disrepair much evidence is still waiting to undergo more accurate and systematic investigation.

It is in this context, then, that I believe an analysis of the decorative program – and particularly the inscriptions – of the dome and the internal walls of the mausoleum of Aḥmad Šāh I Bahmanī (figs. 2-4) suggests the idea of an adherence to Shi'a Islam by the sovereign, and could perhaps contribute to future studies on the development of the Ni'matullāhiyya in the Deccan region.

The mausoleum attributed to Aḥmad Šāh I (fig. 1) is located 2.5 km away from Bidar, within the last Bahmanī royal necropolis, which encloses the tombs of the sovereigns based in the capital. The renowned funerary complex was erected north-east of the city, on the road leading to the vil-

<sup>3</sup> See for example the proceedings of the two last great conferences dedicated to Deccani artistic productions (Haidar, Sardar 2011; Parodi 2014).

lage of Ashtur.<sup>4</sup> The structure – which inaugurated the complex that was later expanded, up until 1527 – both symbolically and artistically seems to perfectly meet the requirement of preserving the memory of the sovereign while epitomizing Bahmanī power, in keeping with a consolidated tradition of patronage perpetuated by many of the Islamic dynasties that ruled the Indian Subcontinent.

The choice of locating the structure in a different city from that of the mausoleums ascribed to the previous sovereigns – all of which are in Gulbarga<sup>5</sup> – was probably due to the move of the capital and the religious and political context at the beginning of Aḥmad Šāh I's reign. The sultan's ascent to the throne was deeply marked by internal struggles between opposing factions, which had broken out with the contrast between himself and his brother and predecessor, Fīrūz Šāh (r. 1397-1422).

Thus, in order to fully understand the early history of the Ni'matullāhiyya in the Deccan, as well as its connection to the ruling authorities and its influence, it is necessary to analyse the political and historical circumstances in which the order was established.<sup>6</sup>

During his reign, Fīrūz Šāh, a man of culture and a generous patron, promoted an agreement between the temporal power held by his dynasty and the spiritual power exercised by the Sufi brotherhoods rooted in the area. Despite the fact that the Bahmanī dynasty had hitherto remained of strict Sunni observance, during Fīrūz Šāh's reign Shi'a Islam acquired an increasingly important role in the Deccan. Probably in the wake of the influx of new settlers from the west – especially Iran and Iraq – and the arrival at court of the 'new immigrants', the *āfāqīs*, the Shi'i doctrine also started spreading among the local population (Eaton 1978, pp. 40-43; Rizvi 1986, pp. 248-251; Coslovi 1990, pp. 97-121). However, until then, the sovereign had been capable of preserving the crucial balance between the various social and religious components of his kingdom – the very balance that was probably lost during the later history of the dynasty.

What probably contributed to the rise of Aḥmad Šāh I to the throne was the deterioration of the relations between Fīrūz Šāh and Sayyid Muḥammad Ḥusaynī Gīsūdirāz (d. 1422), the famous representative of the Čishtiyya

---

4 The complex consists of a small funerary mosque, thirteen mausoleums, and a series of minor tombs and secondary structures that are now in a very poor state (Yazdani 1995, pp. 114-140; Pilon 2012, pp. 91-99).

5 Gulbarga today is known under the name of Kalaburagi. In October 2014, the Indian government approved the plan to change the name of twelve cites in the state of Karnataka, proposing a return to the old Kannada names. In the case of Gulbarga the change brought some protest from Muslims.

6 For the sake of my argument, it is necessary to provide an exhaustive summary of relevant historical and political events. The overview that follows is based on my above-mentioned article (Mondini 2015).





Figure 2. The mausoleum of Ahmad Šāh I Bahmanī, interior (photo: Mondini, 2015)



Figure 3. Aḥmad Šāh I Bahmanī mausoleum, interior. Pictorial decoration and its state of preservation (photo: Mondini, 2015)



Figure 4. Aḥmad Šāh I Bahmanī mausoleum, interior. Pictorial decoration of the dome (photo: Mondini, 2015)

order, whose *dargāh* is still one of the most visited Islamic pilgrimage sites in south-central India. After settling in Gulbarga during the early years of Firūz Šāh's reign, Gīsūdirāz received a warm welcome from the sovereign and acquired a leading role. However, the disagreements between the two soon undermined the popularity of the sultan, much to the benefit of Aḥmad Šāh I, who meanwhile had won the religious leader's favour.<sup>7</sup>

Only a few months after the new ruler came to power, Gīsūdirāz passed away. His death marked not only the disappearance of a figure who had played a crucial role in the social and religious context of the city – and in the history of the dynasty – but also the loss of the main supporter and advocate of Aḥmad Šāh I's political success. It seems likely that once he was deprived of such a popular supporter, the new sovereign came to be regarded as a usurper of his brother's throne and found himself at the mercy of the internal power struggles that had first broken out at the time of his succession. These circumstances may account for the sovereign's decision to move the capital from Gulbarga to Bidar. Aḥmad Šāh I probably hoped to set the political and religious policies of the dynasty on a new course; but in Bidar he still lacked a 'worthy legitimiser' – that is, an authoritative religious figure who might help him regain the consensus required for him to more firmly establish his throne. Aḥmad Šāh I therefore turned to Ni'matullāhiyya, the Iranian Sufi order, repeatedly inviting its leading representative to move to Bidar (Sherwani 1985, pp. 133-134; Siddiqi 1989, pp. 9-81). Following the move of the capital, this 'new' religious orientation, based on the choice of a new supporting and legitimising order, would further appear to confirm the idea of a change of course and the attempt on the sovereign's part to assuage possible critics. At the same time, the choice of the Ni'matullāhiyya must have seemed like an ideal way of dealing with the by then unstoppable social transformations taking place in the Deccan: as a strategic way of consolidating the support given to the ruler by the new class of *āfāqīs* from central Asia. The latter were growing in number and were increasingly becoming involved in politics and opposed to the *dakhnīs*, the political class of the 'Deccanis', the long-established immigrants from the Delhi Sultanate and their descendants.

Ni'matullāh (d. 1430), the founder of the Iranian order, initially turned down the sovereign's offer. A few years later, however, upon Aḥmad Šāh I's insistence, he agreed to send his grandson Nūrullāh to court. This latter was given an extraordinary welcome and the sovereign bestowed upon him

---

7 The deterioration of the relations between Gīsūdirāz and Firūz Šāh eventually led the latter to ask the shaykh of the Ālīshāhiyya to leave his *khānqāh* – which, according to the sources of the period, was situated in the immediate environs of the palace (Firishta 2006, p. 240; Eaton 2008, p. 52). With regard to this event, it is important to note the importance of the location of royal mausoleums and *dargāhs*, as well as their reciprocal proximity within the urban context (Sherwani 1985, pp. 130-131; Mondini 2009).

the title of *malik al-mašā'ikh*, thus in a way asserting his authority over all orders in the area. Following the death of Ni'matullāh, his son Khalīlullāh (d. 1455) – Nūrullāh's father – also moved to the Bahmanī court (Sherwani 1985, p. 134; Siddiqi 1989, pp. 80-83; Aubin 1991, pp. 239-241).

Perhaps the most interesting aspect of the historical and political developments that took place in this phase of Bahmanī rule is Aḥmad Šāh I's enduring attempt not just to consolidate his political role but to establish his authority in the religious sphere as well. Ever since the time of his close contact with Gīsūdirāz, the sovereign had drawn attention for his devotion, not least through his frequent visits to the latter's *khānqāh*. But it was only after the death of his legitimiser that Aḥmad Šāh I's efforts and ambitions seem to emerge most clearly. In this respect, a turning point in the transformation of the sovereign's image would appear to have occurred through his initial contacts with Ni'matullāh, through which the ruler acquired new prestige, adopting the title of *walī*, which in a Sufi context is generally attributed to religious figures (Mondini 2015, pp. 132-133). According to Siddiqi, the title was bestowed on the ruler by Ni'matullāh (1989, p. 80). The latter, having declined the sovereign's invitation to take up residence at the Bahmanī court, nonetheless apparently sent him a letter of 'initiation', addressing him by the title of *walī* and sending him «a cap of discipleship and a robe authorizing the sultan to act as Ni'matullāh's disciple» (Rizvi 1986, pp. 251-252). As already noted by Yazdani, the origin of the title is all but clear (1995, p. 115).<sup>8</sup> Although the title, according to the sources, occurred in the *khutba* and appears on Bahmanī coinage from the period, the only material evidence comes from the reign of Aḥmad Šāh I's successor, 'Alauddin Aḥmad II (r. 1436-1458) (Khan 1964, p. 97; Yazdani 1995, p. 115).

One may cynically assume, then, that after witnessing a 'delay' in the emergence of a new authoritative legitimiser of his power, Aḥmad Šāh I chose to invest himself with the spiritual authority necessary to gain legitimacy, thus seeking to merge his role as a political guide with his new role as a spiritual one. This newly acquired prestige and the way in which the figure of the ruler evolved over the following decades and centuries eventually led to his consecration and veneration as a saint. Still, it is difficult to trace the various stages of this 'construction of identity' in any detail and to establish whether – and to what extent – it was 'planned', or

<sup>8</sup> Firishta traces the origin of the title bestowed to Aḥmad Šāh I back to a miracle, which the sovereign reputedly performed by bringing rain during a drought through the power of his prayers, thus stirring his subjects' fervor and devotion (Firishta 2006, p. 250). The attribution of the 'rain miracle' to Aḥmad Šāh I, however, can easily be identified as one of the most recurrent *topoi* in Islamic hagiography, which frequently ascribes the effective use of *ṣalāt al-istisqā'* (lit. 'prayer for the rain') to religious figures throughout history. The explanation of the title by the historiographer would appear not so much to reflect actual reality as to effectively meet the need to sanctify the sovereign.

simply the outcome of a lucky coincidence which the sovereign succeeded in seizing and making the most of politically. What is certain is that Aḥmad Šāh I not only came to be acknowledged and counted among the followers of the Ni'matullāhiyya, but was also assigned the title of *walī* – in the sense of 'saint', rather than simply 'disciple'<sup>9</sup> – and credited with miracles and healing powers. On his part, moreover, the sovereign bound his family to that of his new legitimiser, blending his own line with the *silsila* of the Ni'matullāhiyya order even more closely (Siddiqi 1989, p. 161).

Aḥmad Šāh I thus came to superimpose his alleged qualities as a spiritual authority upon his role as sovereign. These qualities, which continue to be celebrated to this day, led to the veneration of his figure and tomb – much in the same way as the most important Sufi saints of the Deccan, and of India more generally, are venerated. Following Aḥmad Šāh I's death, his son and heir to the throne 'Alauddin Aḥmad II had a magnificent mausoleum erected in his father's honour: it is a gem of late Bahmanī architecture and is now a *ziyāra* destination. Both 'Alauddin Aḥmad II and his successor, 'Alauddin Humayun Zalim (r. 1458-1461) also minted coins proclaiming them as the descendants of Aḥmad Šāh I Walī (Khan 1964, pp. 97, 112).

The new fame and the new role bestowed upon the figure of Aḥmad Šāh I are clearly reflected today by the powers attributed to his tomb, and especially by the acknowledged importance of visiting it. Locally, the tomb is even regarded as being a more important destination than the nearby *dargāh* devoted to Khalīlullāh Kirmāni, his descendant and disciple.<sup>10</sup> While, strictly speaking, the funerary structure devoted to him cannot be regarded as a *dargāh* – since in India the term is usually restricted to funerary complexes devoted to saints and representatives of Sufi brotherhoods – and although the appeal exercised by the mausoleum cannot be compared to that of the main *dargāhs* in the region, such as Khuldabad or the *dargāh* dedicated to Gīsūdirāz at Gulbarga,

---

9 The Arab term *walī* covers a range of meanings related to the authority, protection, and care exercised by the *walī* towards the people who entrust themselves to him (for God is the best *walī*). A complementary meaning of *walī* is 'servant': the term designates the loyal and obedient servant who loves his lord and hence is close to him. Thus, in our specific context, the term *walī* acquires a meaning very close to that of *mawlā* (which stems from the same root and literally describes the personal, intimate servant of a master, who enjoys his proximity and trust). Just like the *mawlā*, within the limits of his subordinate position, the *walī* is a friend to his master, whose will he perfectly conforms to. Hence the translation of the term *walī* as 'saint', friend of God, as a confirmation of his proximity to the divine (Mondini 2015, pp. 132-133).

10 Whereas the pilgrimage to Ahmad I Shah's mausoleum and the veneration of his tomb would appear to have become established practices – destined to endure more or less uninterrupted down to the present – immediately after the ruler's death, what makes the modern interpretation of the site and the rites connected to it even more difficult is the acknowledgment of the religious authority of Aḥmad Šāh I on the part of Hindus as well, and especially of *Lingayats* (Mondini 2015).



the monument still continues to attract thousands of pilgrims. The great celebrations that takes place each year on the anniversary of the rulers' death (*'urs*)<sup>11</sup> and the constant stream of Hindu and Muslim pilgrims who make their way across the silent countryside to pay homage to the tomb, intrinsically reveal how the religious authority of Aḥmad Šāh I has long outweighed his role as a sovereign. A range of different powers are attributed to the ruler-saint: healing powers, the ability to solve fertility problems, and more generally the possibility of acting as an intermediary with God – by virtue of his proximity to the divine as a *walī* – and hence the capacity to dispense *baraka*. As is customary, after Aḥmad Šāh I's death, the powers attributed to him were transferred to his tomb, which became a symbol of his presence and charisma and a physical means for their transmission.

While the dynamics of the mausoleum's frequentation have been discussed elsewhere (Sherwani 1985, pp. 135-137; Sikand 2003, pp. 82-83; Yazdani 1995, pp. 115-116; Mondini 2015, pp. 133-141), for the sake of the present enquiry it is important to examine the stylistic elements of the structure and the information we can infer from them.

In the Deccan as elsewhere, artistic and architectural patronage met the constant need to represent political power and fulfil propaganda requirements by visually conveying the distinguishing features of ruling dynasties. This often meant the use of select registers and especially inspiring models and symbolic elements even in the architectural field: as might be expected, the peculiarities of patronised monuments and their specific location at times make up for existing gaps in terms of identity or religious orientation. From this point of view, the mausoleum of Aḥmad Šāh I constitutes a striking example.<sup>12</sup>

In terms of shape – a quadrangular layout with a domed roof – and exterior decorations, the building (fig. 1) reflects models and tendencies commonly adopted in the region, starting from the model of the mausoleum dedicated to the first legitimiser of Aḥmad Šāh I, Gīsūdirāz.<sup>13</sup> The

**11** From Arabic *'urs*, lit. 'marriage', it stands for the union with one's beloved – the divine. In Muslim India, annual celebrations of this kind are usually reserved for Sufi saints: they are meant to commemorate the saints' union with God on the anniversary of their death. While it is true that throughout its history India has also witnessed celebrations held for the *'urs* of sovereigns such as Aurangzēb (d. 1707) and Mumtāz Mahal (d. 1631), or of famous poets such as Bidel (d. 1720) (Green 2004, p. 135, 142), contemporary research enables us to appreciate just how striking the endurance of the celebrations for Aḥmad Šāh I are, and what great influence they exert – at least on a regional level (Mondini 2015).

**12** I wish to thank my colleague Vicente Martí Tormo for the endless discussions and fruitful critical exchanges we had during the drafting of this work.

**13** Although some scholars stress the differences between the mausoleums dedicated to Gīsūdirāz, Fīrūz Šāh and Aḥmad Šāh I, a broader comparative analysis of the Bahmanī buildings in Gulbarga and Bidar brings out the main features shared by the three mon-

interior, however, presents some of the most remarkable and sophisticated decorations to be found in the region. Despite their serious deterioration, it is possible to appreciate how both the walls and the dome originally featured a magnificent painted decorative programme consisting of floral arabesques of Persian inspiration, interspersed with geometrical motifs and calligraphic bands skilfully developed according to the *kufi*, *naskh* and *thuluth* styles (figs. 3-4).

The complex decorative programme of the building – which finds no parallel in fifteenth-century Indo-Islamic art<sup>14</sup> (figs. 3-5) – is mentioned in all the leading studies published on the artistic heritage of the region, as well as in relation to its political and religious history. Yazdani provides an accurate description of the decorative elements and a partial translation of the inscriptions (1995, pp. 114-128). The omissions are probably due to the poor state of conservation of the decorations in the 1950s (p. 114) – and the situation nowadays is even worse. The limited visibility, due to the little light filtering through the entrance and the lower *jalīs*, combined with the poor state of conservation of the decorations, makes the inscriptions difficult to identify and decipher.

In recent years, the restoration of the painted decorations has only concerned a small part of the interior walls. Still, they have proven useful insofar as they have brought back the bright colours which now give visitors an idea of the original splendour of the interior. Aside from whole fragments of inscriptions that are flaking off or are covered in grime, traces are to be found of recent alterations, although it is unclear whether these only affected the colour of the inscriptions or also their text.<sup>15</sup> As things stand, the decorations on the wall are difficult to interpret and a complete analysis is impossible. What seems comparatively easier is an analysis of the epigraphic bands on the dome (figs. 4, 6), which may provide the information required for the sake of the present argument.

The painted decorations, recently described by Philon (2000), bring out the layout of the interior. While the lower section is punctuated by blind

uments, namely their general layout and the exterior as well as the interior decorative elements.

**14** Philon notes how the painted decorations of the mausoleum not only find no parallel in fourteenth- and fifteenth-century south-Asian art, but may be regarded as important evidence for Islamic painting in this period, which is otherwise only evidenced by limited Yemenite, early Ottoman, and Timurid examples (2000, p. 5).

**15** In certain cases the colours visible today appear to be inverted compared to Yazdani's descriptions. For instance, Yazdani describes the background of the inscriptions enclosed within the eight ovals as red, while today it looks dark (possibly dark green), and traces of red only survive within certain letters (fig. 4) (Yazdani 1995, p. 118). Moreover, the lower inscription, skirting the four walls of the mausoleum, would appear to have been touched-up, even though it is not entirely legible (fig. 5).



Figure 5. Aḥmad Šāh I Bahmanī mausoleum, interior. Pictorial decoration of the walls, epigraphic bands (photo: Mondini, 2015)

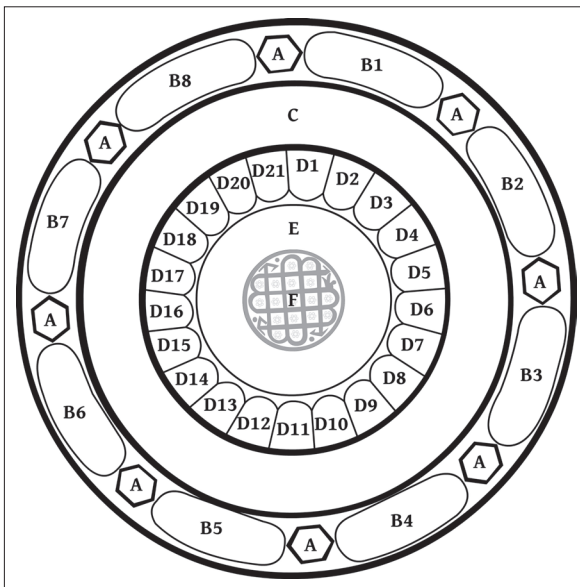

Figure 6. Aḥmad Šāh I Bahmanī mausoleum, interior. Pictorial decoration of the dome, analysis diagram of the epigraphic bands

niches, mouldings, and panels chiefly adorned with geometric and floral patterns, the upper section is centred around the dome: the painted decorations mark its outline, drawing the viewer's gaze towards the apex. The strength of the decorative programme lies in the remarkable variety of shapes and the sophisticated, marked contrast of colours that seem to envelop the whole space, lending depth to the representations, and especially to the textual element - the guiding thread of the decorative programme.



The dome is partitioned by a series of concentric bands (figs. 4, 6). The first, just above the zone of transition, are filled with plant motifs, while the upper bands include extensive inscriptions.<sup>16</sup>

The first epigraphic ring (fig. 6; A, B) comprises eight oval panels with blessings on the Prophet, his descendants and other prophets, interspersed with small hexagons with 'Alī's name repeated over and over. An analysis of the inscriptions shows that Yazdani's interpretation and translation are largely correct:

*Inscription and translation (figs. 4, 6):<sup>17</sup>*

- B1 بسم الله الرحمن الرحيم. اللهم صل على محمد  
B2 أما اختلف الملوان والتعاقب العصران وتكرر الجديان  
B3 واضاء القمران بلغ منّا روح محمد تحيةً وسلاماً و  
B4 اللهم صل على محمد عبدك ورسولك النبي الأمي  
B5 وعلى آل محمد وسلم اللهم صل على محمد سيّد الأوّالين  
B6 وصل على محمد سيّد الآخرين اللهم صل على محمد وعلى  
B7 آل محمد وسلم وبارك وصل على جميع الانبياء والمرسلين و  
B8 الملائكة المقربين وعبادك الصالحين والحمد لله ربّ العالمين

- B1 In the name of God the Most Merciful and the Most Compassionate.  
Oh god bless Muḥammad  
B2 until the day and night differ, and the two periods ('Past' and 'Present') come one in reverse succession to the other, and the day and night follow one another,  
B3 and the two luminaries (sun and moon) shine. Convey from us to the soul of Muḥammad benedictions and salutations. And  
B4 Oh God, bless Muḥammad, Thy servant and apostle, the illiterate Prophet,  
B5 and the progeny of Muḥammad and assail them. Oh God bless Muḥammad, the lord of the early nations,  
B6 and bless Muḥammad, the lord of the coming nations. Oh god bless Muḥammad and  
B7 his descendants and assail them. And bless and grant benediction to all prophets and apostles sent by Thee,

<sup>16</sup> It is worth noting that while these inscriptions are better preserved than the texts on the walls, in some parts they are still difficult to make out: any doubts concerning their interpretation have been flagged in the transcriptions and translations.

<sup>17</sup> Translation quoted from Yazdani (1995, pp. 118-119 n. 4).

B8 all angels who are in close attendance on Thee, and all servants of Thine who are pious: and all praise unto god, the Cherisher of all the worlds.

The second ring (fig. 6; C), with no subdivisions, features a *silsila* linking Ni'matullāh to the founder of the Qādiriyya.<sup>18</sup>

*Inscription and translation* (figs. 4, 6):<sup>19</sup>

C

محمّد رسول الله, علي المرتضى, حسن البصري, حبيب العجمي, داود الطائي, معروف الكرخي,  
سري السقطي, جنيد البغدادي, ابو علي رودباري, ابو علي الكاتب, ابو عثمان المغربي, الشيخ  
ابو القاسم, ابو بكر النّسّاج, احمد الغزالي, ابو الفضل البغدادي, ابو البركات ابو سعيد الاندلسي,  
ابو مدين المغربي, ابو الفتوح السعيد, كمال الدين الكوفي, صالح التبريزي, عبد الله يافعي,  
نعمت الله الحسيني

C

Muḥammad Rasūl Allāh, 'Alī al-Murtaḍā, Ḥasan al-Baṣrī, Ḥabīb al-'Ajamī, Dāwud al-Ṭā'ī, Ma'rūf al-Karkhī, Sarī al-Saqatī, Junayd al-Bagḍādī, Abū 'Alī Rūdbārī, Abū 'Alī al-Kātib, Abū 'Uṭmān al-Magribī, al-Ṣaykh Abū al-Qāsim, Abū Bakr al-Nassāj, Aḥmad al-Gazzālī, Abū al-Faḍl al-Bagḍādī, Abū al-Barakāt Abū Sa'īd al-Andalusī, Abū Madyan al-Magribī, Abū al-Futūḥ al-Sa'īd, Kamāl al-Dīn al-Kūfī, Ṣāliḥ al-Tibrizī, 'Abd Allāh Yāfi'i, Ni'mat Allāh al-Ḥusaynī

The third ring (fig. 6; D) is divided into twenty-one sections, each of which encloses a name. Through this second *silsila*, an attempt is made to establish a connection between Ni'matullāh and Junayd al-Bagḍādī via the former's distinguished disciple Abū 'Alī Rūdbārī (Yazdani 1995, p. 115).

<sup>18</sup> It should be noted that Ni'matullāhiyya is regarded as a sub-branch of the Qādiri order (Siddiqi 1989, p. 78).

<sup>19</sup> Transcription quoted from Yazdani (1995, p. 115 n. 3).

*Inscription and translation (figs. 4, 6):<sup>20</sup>*

D1 داود D5 حبيب العجمي D4 حسن البصري D3 علي المرتضى D2 محمّد المصطفى  
 الشبلي (ابو بكر) D9 جنيد البغدادي D8 سري السقطي D7 معروف الكرخي D6 الطائي  
 علي الهكاري D12 ابو الفرح زنگاني D11 ابو الفضل التيمي D10  
 (المحزومي؟) ابو سعيد المحزومي D13  
 احمد الواسطي D17 محي الدين العربي D16 يونس التيمي D15 عبد القادر الجيلاني D14  
 نعمت الله الولي D21 عبد الله (يافعي) D20 ابراهيم المكي D19 مجير.....ني D18

D1 Muḥammad al-Muṣṭafā, D2 ‘Alī al-Murtaḍā, D3 Ḥasan al-Baṣrī, D4 Ḥabīb al-‘Ajamī, D5 Dāwud al-Ṭā‘ī, D6 Ma’rūf al-Karkhī, D7 Sarī al-Saqāṭī, D8 Junayd al-Bagḍādī, D9 al-Šiblī (Abū Bakr), D10 Abū al-Faḍl al-Tīmī, D11 Abū al-Faraj Zanḡānī, D12 ‘Alī al-Hikārī, D13 Abū Sa‘īd al-Muḥzamī (al-Maḥzūmī?), D14 ‘Abd al-Qādir al-Jilānī, D15 Yūnis al-Tīmī, D16 Muḥīy al-Dīn al-‘Arabī, D17 Aḥmad al-Wāsiṭī, D18 Mujīr...nī, D19 Ibrāhīm al-Makkī, D20 ‘Abd Allāh (Yāfi‘ī), D21 Ni‘mat Allāh al-Walī

The fourth ring (fig. 6; E), again with no subdivisions, does not appear to have been transcribed or translated by Yazdani. It features an invocation (*durūd*) of the twelve imams of Twelver Shi‘a Islam, as well as of the Prophet Muḥammad and his daughter Fāṭima.

*Inscription and translation (figs. 4, 6, 7):<sup>21</sup>*

E

اللَّهُمَّ صَلِّ عَلَى مُحَمَّدٍ الْمُصْطَفَى وَعَلَى الْمُرْتَضَى وَفَاطِمَةَ الزَّهْرَاءِ وَالْحَسَنَ الْمَوْجِبَتِي وَالْحُسَيْنَ  
 الشَّهِيدَ بِكَرْبَلَاءَ وَعَلَى زَيْنِ الْعَابِدِينَ، وَمُحَمَّدَ الْبَاقِرِ، وَجَعْفَرَ الصَّادِقِ، وَمُوسَى الْكَاطِمِ، وَعَلَى الرِّضَا،  
 وَمُحَمَّدَ الْجَوَادِ، وَعَلَى الْهَادِي، وَالْحَسَنَ الْعَسْكَرِيِّ، وَالْحُجَّةَ الْقَائِمَ مُحَمَّدَ الْمَهْدِي

E

Allahumma ṣalli ‘alā muḥammad al-muṣṭafā wa-‘alī al-murtaḍā wa-fāṭima al-zahrā’ wa-l-ḥasan al-mujtabā wa-l-ḥusayn al-šahīd bi-karbalā’ wa-‘alī zayn al-‘ābidīn wa-muḥammad al-bāqir wa-ja‘far al-šādiq wa-mūsā [mūsā] al-kāzim wa-‘alī al-riḍā, wa-muḥammad al-jawwād wa-l-ḥasan al-‘askarī wa-l-ḥujja al-qā’im muḥammad al-mahdī

20 Transcription quoted from Yazdani (1995, p. 115 n. 3). Where Yazdani reads ‘al-Tīmī’ we should probably read ‘al-Tamīmī’ (D10; D15); and Abū al-Faraj Zanḡānī (D11) reported by the inscription should be identified with Abū al-Faraj al-Ṭurtūsī.

21 This text is not included in Yazdani’s work (1995, pp. 114-128).



Figure 7. Aḥmad Šāh I Bahmanī mausoleum, interior. Pictorial decoration of the dome, epigraphic band ‘E’

By marking out the names occurring in the decorative ring with the *durūd* (figs. 6, 7), one reads:

Muḥammad al-Muṣṭafā  
 ‘Alī al-Murtaḍā  
 Fāṭima al-Zahrā’  
 al-Ḥasan al-Mujtabā  
 al-Ḥusayn al-Šahīd bi-Karbalā’  
 Alī Zayn al-‘Ābidīn  
 Muḥammad al-Bāqir  
 Ja‘far al-Šādiq  
 Mūsā al-Kāzim  
 ‘Alī al-Riḍā  
 Muḥammad al-Jawwād  
 al-Ḥasan al-‘Askarī  
 al-Ḥujja al-Qā’im Muḥammad al-Mahdī

Finally, the central disc at the apex of the dome (Fig.6; F) is filled by what Yazdani has identified as a *tuḡrā* with the name of Allāh and the *pan-jetan* – lit. ‘the five’, i.e. the five names of Muḥammad, ‘Alī, Fāṭima, Ḥasan and Ḥusayn (1995, p. 119). Philon instead believes this to be a repetition of the name of Allāh (2000, p. 7).

Although the work of Yazdani (1995) remains of crucial importance, it

now seems necessary to conduct a study of the inscriptions that is more than just descriptive and is supported by an adequate analysis of the political and religious context in which the monument was built.

In their – often cursory – analysis of these decorations, many scholars have addressed the issue of the religious orientation of Aḥmad Šāh I – and hence of the Ni‘matullāhiyya order –, but without reaching any consensus on the matter. Yazdani briefly deals with the question by stressing the lack of any real proof of the sovereign’s adherence to Shi‘a Islam, and noting in particular the lack of *walī* (saints) within this religious tradition (1995, pp. 115-116). Previously, Haig had reached very different conclusions: he had stressed the importance of the decorations we are examining precisely as conclusive evidence of the ruler’s new Shi‘i persuasion (1924, pp. 78-79). Sherwani, a distinguished expert of Deccani history, is sceptical about Haig’s theory: like Yazdani, he attributes the fine quality of the decorations and the repetition of the name of ‘Alī to the hand of the calligrapher, in all likelihood a Shi‘ite himself (Sherwani, however, identifies the calligrapher with Mughīs of Shīrāz, contrary to what emerges from Yazdani’s translation, where he is identified as «Shukr-Ullāh al-Qazvīnī, the painter»<sup>22</sup>). Sherwani acknowledges that the decorations are evidence «of the Sufic or perhaps Shi‘ah influence par excellence» (1985, p. 131). However, although he refers to episodes which might suggest an inclination towards Shi‘a Islam on the part of Aḥmad Šāh I, the scholar examines the evidence for the spread of Shi‘a in a Bahmanī context by focusing on later decades, in particular starting from the arrival of Maḥmūd Gāwān in Bidar in 1453 (Sherwani 1985, pp. 274-277).<sup>23</sup> Rizvi, who refers to both Haig’s and Sherwani’s theories, acknowledges that the absence of the names of the other three ‘Rightly Guided Caliphs’ (*al-khulafā’ al-rāshidūn*) – Abū Bakr, ‘Umar and ‘Uthmān – is certainly noteworthy in the mausoleum of a Sunni sovereign. But while he follows Sherwani’s opinion in acknowledging the decorations to be ‘predominantly Shi‘i’, Rizvi appears to downplay their importance: he once again assigns the calligrapher a key role<sup>24</sup> and regards the inscriptions as simply intended to trace Ni‘matullāh’s descent from ‘Alī – based on the idea that his father was a *sayyid*, a descendant of Ismā‘īl b. Jafar – in such a way

22 «The interior was decorated under the supervision of the calligraphist Mughith of Shirazi» (Sherwani 1985, p. 131). Sherwani, however, gives no sources for this name. According to Yazdani, the name mentioned in the inscriptions above the *mihrab* and three entrance arches (north, east and south) of the mausoleum of Aḥmad Šāh I is Shukr-Ullāh al-Qazvīnī: «The work of the servant, Shukr-Ullāh al-Qazvīnī, the painter» (1995, pp. 125-126). Yazdani also claims that the name of Mughīs of Shīrāz is to be found in the nearby mausoleum of Khalīlullāh Kirmāni (1995, pp. 125-126).

23 On the social and religious composition of the Bahmanī kingdom in the years in question, see also Eaton 2008, pp. 59-77.

24 Quoting Sherwani, Rizvi identifies this calligrapher as Mughīs of Shīrāzi (1986, pp. 251-256).

as to win the favour of the 'new' subjects (Rizvi 1986, pp. 251-256). Rizvi further emphasizes how the names of the imams are «set in the scheme of the names of Shāh Ni'matullāh Walī and his spiritual ancestors who had not declared themselves Shī'īs», thus noting that the evidence is inconclusive (Rizvi 1986, p. 255). One discordant voice is that of Khalidi who, probably taking up Haig's theory, claims that «in 1429 Aḥmad Shāh Walī Bahmanī (1422-1436) was overtly converted to Shi'ism» (1990, p. 5).

At present, it seems difficult, if not impossible, to find support for either of these theses concerning the religious persuasion of Aḥmad Šāh I, given the doubts that endure despite the textual analyses which have been conducted. Another open problem is that of the social and religious changes which occurred in the Deccan in the period under consideration. So far, many historians and art scholars – including the present writer – have adopted an approach revolving around the idea of the contrast between two social groups – *dakhnīs* and *āfāqīs*, or *mulkīs* and *ghayr-mulkīs* – rooted in the Deccan, based on the vain assumption that this might contribute to shed light on political and religious dynamics in the region. However, the underlying concept through which the identity of these two groups is established – the notion of a more extended presence in the region, of being older 'immigrants' – seems rather questionable.<sup>25</sup> What became of these two groups in subsequent generations? In particular, did second or third-generation *āfāqīs* continue to regard themselves or to be perceived as 'foreigners'? One further problem related to the identity of these two groups is their religion. As Roy Fischel has noted, the sources – at any rate those pertaining to the first Bahmanī phase in Gulbarga – would not appear to report any spread of Shi'a Islam in the region (2014). But if the distinction between *dakhnīs* and *āfāqīs* was exclusively a matter of provenance and 'arrival date', then on what grounds did the *ḥabshīs* – the Abyssinians who reached the region in growing numbers in the decades in questions, swelling the ranks of Deccani armies as slaves – side with the *dakhnīs* instead of the *āfāqīs* in power struggles, as would appear to have been the case? (Sherwani 1985, p. 131 n. 2, p. 134 n. 3; Eaton 2006, pp. 115-124)

While many questions remain open for now, certain features of the decorative programme of the mausoleum may be seen to provide significant clues.

The overall decorative plan adopted for the dome was not new within the context of the Deccan. Concentric epigraphic bands – often consisting of painted stucco-work – adorn the upper part of domes or walls in several mausoleums from the later Bahmanī phase in Gulbarga, the first Bahmanī capital. This kind of decoration prominently occurs in the two most important mausoleums among those chronologically and stylistically

25 I here wish to thank Prof. Sunil Kumar for his insights on the occasion of the Simon Digby Memorial Conference.

close to Aḥmad Šāh I's monument: the mausoleum of Fīrūz Šāh and that of Gīsūdirāz. Although traces of colour are to be found in these decorations in Gulbarga, the evidence is not sufficient to enable us to reconstruct any dominant trends or style; in any case, these traces are not comparable to those found in the mausoleum of Aḥmad Šāh I. Painting would appear to have acquired a key role at the beginning of the Bidar phase, in parallel with the consolidation of typically central Asian stylistic elements – one may refer here to the decorations found inside Bidar Fort (Curatola 1990, pp. 195-234) and to the use of the Persian arch, which was adopted for the first time precisely for the mausoleum of Aḥmad Šāh I (Merklinger 1981, p. 83; Philon 2000, p. 4). No doubt, the most crucial elements to be taken into account are the epigraphic bands on the dome. In terms of content, the inscriptions inside the mausoleum of Aḥmad Šāh I would appear to mark a real break from those in Gulbarga. Although a systematic comparative study of inscriptions from the Bahmanī period has yet to be conducted, a survey of the material published so far and my own on-site investigations suggest that in the first Bahmanī phase the decorative repertoire chiefly consisted of Koranic inscriptions and the use of the 99 names of God (*'asmā' al-ḥusnā*). What emerges, then, is the significant absence of 'Alī's name or any allusions to the *panjetan* – at any rate from the monuments examined so far.

One further element which I wish to focus on is again related to the content of the inscriptions. While the two chains of authority I have presented would be compatible with the idea of the ruler's commitment to the Ni'matullāhiyya order – with the exception, perhaps, of the mention of Muḥīy al-Dīn al-'Arabī – the twelve imams mentioned in the invocation (*durūd*) are no doubt those acknowledged by the Twelver Shi'a tradition.<sup>26</sup> The choice of featuring a full list of all the twelve Shi'i imams in the interior of an allegedly Sunni mausoleum can hardly be viewed as simply an attempt to assert the descent of the ruler's 'legitimiser' from 'Alī. But what is most remarkable in the context of the mausoleum is the use of the adjective 'martyr' (*al-šahīd bi-karbalā'*, martyr of Kerbala) in relation to al-Ḥusayn's name, which confirms the impression that the inscriptions may have served an additional purpose.<sup>27</sup> In the light of the extremely innovative character of this content in the Deccani context and of its striking powerful message – a point I will shortly return to – I would be wary of laying the responsibility for the choice of the inscriptions exclusively on the calligrapher, as Sherwani has done, followed by Rizvi – «The interior was decorated under the supervision of the calligraphist Mughīs of Shīrāz, perhaps himself of Shi'a

---

26 I here wish to thank Alessandro Cancian for his valuable observations and suggestions.

27 One may consider the fact that in the inscriptions of the *miḥrab* of the Great Mosque at Bijapur, for instance, the names of 'Alī, Ḥasan and Ḥusayn not only lack any adjectives of this sort, but are accompanied – within the complex epigraphic programme – by the names of the other Rightly Guided Caliphs (Mondini, forthcoming).



persuasion, who has inscribed the names of the apostle of Islam and the fourth caliph 'Alī in a hundred ways and inserted the Shi'ite daruud» (Rizvi 1986, p. 255). Judging from what we know about patterns of patronage in Muslim India, it is difficult to accept the idea that the calligrapher may have created such a striking decorative scheme – especially given that the elements at play are far from marginal – without the consent and approval of his sovereign or patron. The powerful message delivered by the inscriptions, which I trust the present analysis has made quite clear, is precisely what jars with the idea of *taqiyya*, or 'dissimulation'<sup>28</sup> – a practice believed to have been in force in the Bahmanī kingdom up until the age of Maḥmūd Gāwān, on account of the open contrast between *dakhnīs* and *āfāqīs* (Allan 2012, pp. 60-61) – thereby undermining the notion of a merely private adherence to Shi'a Islam on the part of Aḥmad Šāh I.

As already noted, we still lack a systematic comparison with the earlier corpus of inscriptions from the Deccan. An easier task would be to draw a comparison with the later inscriptions commissioned by the dynasties of the Niḏāmšāhis, 'Ādilšāhis, and Qutbšāhis. In his work *The Art and Architecture of Twelver Shi'ism*, Allan (2012) identifies in later Deccani architecture a series of structural and decorative elements connected to Shi'a that may be regarded as – often unmistakable – markers of religious belief. While, as Allan himself notes, Indian art has yet to be subjected to a systematic investigation of the sort which has been conducted on Fatimid art (Allan 2012, p. 63), by adopting his approach one soon realizes that certain decorative elements of the mausoleum of Aḥmad Šāh I are distinctly Shi'i.

First of all, it is worth noting the repetition of 'Alī's name. In the first ring of inscriptions, the name of the fourth caliph is repeated three times within each of the small hexagons between the ovals containing the blessings (figs. 4, 6; A). This recurrent use of the name is unusual in itself for a 'Sunnī monument', given the aforementioned absence of the names of the other Rightly Guided Caliphs. It appears even more significant, if we consider the fact that the name 'Alī (mentioned no less than twenty-four times in the hexagons alone) is far more frequent than that of the Prophet Muḥammad.

One further element is the presence at the apex of the dome of what Yazdani has identified as the *panjetan* in the shape of a *tuḡrā* featuring the five names of Muḥammad, 'Alī, Fāṭima, Ḥasan, and Ḥusayn (1995, p. 119) – another element which Allan lists among the recurrent decorative features of monuments commissioned by Shi'i patrons in the Deccan. As an example, one may refer here to the *panjetan* which was added on the blind arch of the entrance gate of Gīsūdirāz's mausoleum with the restoration work carried out under the 'Ādilšāhis (Allan 2012, pp. 65, 77).

28 According to this practice, a pious Shi'i Muslim may conceal his faith, if public acknowledgment of it would endanger his or his family's life.



Figure 8. Mausoleum of Aḥmad Šāh I Bahmanī, interior. Three 'alams preserved and still used in occasion of the sovereign's'urs (photo by the Author, 2015)

Although in the case of the mausoleum of Aḥmad Šāh I it is difficult to make out the *panjetan* in the shape of a *tuḡrā* described by Yazdani – the above-mentioned hypothesis suggested by Philon (2000, p. 7) seems here more plausible – there is no doubt that the five names play a key role within the decorative scheme of the building. Considering that decorative elements are often hierarchically arranged, it is also significant that the names of the imams of Twelver Shi'a Islam are displayed immediately after those of the Prophet and his daughter Fāṭima, near the centre of the dome. In the Deccan, most inscriptions of this sort were commissioned by the – openly Shi'i – dynasties that followed the Bahmanī within Sufi shrines and family mausoleums, in which case they usually adorn the ruler's cenotaph. Let us think here of the cenotaph of Muḥammad Qulī Qutbšāhis (d. 1602) in the royal necropolis of Golkonda, which combines Koranic inscriptions with an invocation of the twelve imams (Allan 2012, pp. 65-66).

Finally, it is interesting to note that three specimens of 'alam are preserved in the mausoleum of Aḥmad Šāh I (fig. 8). This kind of standard



Figure 9. Khalilullāh Kirmāni dargāh, Ashtur (Bidar), external facade of the monumental gateway (photo: Mondini, 2015)



Figure 10. Khalilullāh Kirmāni dargāh, Ashtur (Bidar), detail of the gateway's facade (photo: Mondini, 2015)

is the most distinctive item to be found in the processions held for the Muḥarram celebrations in many Shi'i cities, including in India. Its origins apparently lie in the *'alam* which Ḥusayn's brother 'Abbās carried in the Battle of Kerbala (Allan 2012, p. 121). As far as I am aware, only one of the three (considerably damaged) standards in the mausoleum has ever been studied in any detail: first published by Allan (p. 132), this is an item of Indian or Iranian craftsmanship which presumably dates from the seventeenth century. While it is impossible to trace the history of these three *'alam* and define their place in the context we are investigating,<sup>29</sup> not least in the light of their current use in *'urs* celebrations, they may well reflect a degree of 'Shi'ization' (pp. 121-138) – possibly at a later date – not just of the site but of the ritual practices performed at the mausoleum to this day.

<sup>29</sup> Allan notes that increasing immigration from Iran no doubt led to the importation of Persian customs and objects into the Deccan; and it is reasonable to assume that the flow of objects also went in the opposite direction (2012, p. 131).

Although the elements identified so far do not constitute irrefutable proof of Aḥmad Šāh I's conversion to Shi'a Islam, they certainly suggest that the mausoleum represents a unique monument and one of crucial importance for any study of the history and religion of the Deccan.

In order to clarify some of the doubts which have emerged in the course of the analysis, an in-depth investigation ought to be conducted of the inscriptions on the walls of the mausoleum of Aḥmad Šāh I, which Yazdani identifies as passages from the writing of Ni'matullāh himself (1995, pp. 117-128). These texts should first of all be compared to the inscriptions from the Chaukhandi, the nearby *dargāh* dedicated to Khalīlullāh Kirmāni, of which only a partial study has been made by Yazdani (1995, pp. 141-146). What is once again surprising, in the case of the complex dedicated to the local representatives of the Ni'matullāhiyya order, is the presence of 'Alī's name, combined with that of the Prophet, on the grand arch marking the entrance: the name occurs both in the inscriptions within the medallions on the extrados of the arch (fig. 10) and at the end of an epigraphic band featuring the *ayyat al-kursi*, followed by the addition 'Allāh, Muḥammad, 'Alī' (fig. 9). It would therefore be useful to establish first of all whether the inscriptions are original and coeval to the *dargāh* itself – as would seem to be the case – and whether they offer any further clues (Mondini forthcoming); and, secondly, whether in this case too the choice of mentioning the fourth caliph so often, according to what is usually a Shi'i practice, merely reflects a desire to emphasize a descent from 'Alī, as suggested by most of the studies mentioned in the present contribution.

One last term of comparison that might help shed light on the figure of Aḥmad Šāh I and his relation to the Ni'matullāhiyya order is the mausoleum of Ni'matullāh in Kirmān, Iran, which was presumably commissioned by the Bahmanī ruler (Golombek, Wilder 1988a, pp. 394-395; 1988b, pp. 401-402). This funerary complex, which has been dated to 1436, was considerably enlarged and modified over the centuries. The original structure, which may plausibly be assigned to Aḥmad Šāh I, featured a sophisticated programme of decorative inscriptions. Later alterations notwithstanding, it would be useful and interesting to investigate possible affinities between the two structures, from an architectural perspective as well as in terms of decorative inscriptions.

In the light of the elements highlighted so far, and of what we know about mutual stylistic influences among Islamic funerary monuments in the Deccan and about the symbols and language they share (Mondini 2009, pp. 513-529), we may now consider whether and in what way the decorations and inscriptions in the mausoleum attributed to Aḥmad Šāh I contribute to defining the ruler's political and religious orientation. On the one hand, the systematic building of funerary monuments, which constitutes a striking development in the Indian context, would appear to have traced a new geography, stemming from the merging of political and sacred geog-

raphy – the latter being radically conditioned by political dynamics, which it in turn influenced and shaped. On the other hand, the creation of these monuments would appear to have legitimised and consolidated dynastic and political modes of expression.

Regardless of whether Aḥmad Šāh I is to be regarded as a ‘Shi‘i’ or ‘Sunni’ sovereign, genealogy clearly emerges as a crucial element in the definition of his political and religious identity. The iconographic programme of the ruler’s tomb foreshadows the more famous Mughal miniatures portraying sovereigns as Timur’s descendants and showing their investiture at the hands of either Timur himself or Sufi shaykhs. The iconography of the mausoleum, however, goes even further: it establishes an official space within which the sovereign – that is, his body – is ‘surmounted’ by the *silsila* both of his spiritual masters and of the twelve imams. It is as though the ruler, through his very presence and (now) everlasting charisma, were closing that chain by symbolically presenting himself as the descendant of these figures, and at the same time as a political and spiritual guide. The ruler is both comforted and supported by the figures mentioned in the inscriptions and symbolically invested with the authority of those who came before him. This double symbolic significance of the space recalls those ‘visual strategies’ of propaganda which later became widespread throughout the Subcontinent. The mausoleum thus paved the way for the instrumental use which the successors of Aḥmad Šāh I were to make of their predecessor’s title of *walī*. This brings to mind the strategic use of art for propaganda purposes made by the aforementioned Mughals (1526-1857); or, again, the double symbolic significance of the sculptures of rulers installed in the pavilions of Tamil Nadu temples from the sixteenth century onwards, where the deity displayed during festivals on the one hand supported and legitimised the line of sovereigns portrayed as devotees, and on the other was itself part of the sovereign’s genealogy (Branfoot 2007, pp. 225-240).

The analysis conducted so far therefore suggests that the figure of the ruler-saint and his legitimation were no longer exclusively supported – as had been the case in the previous capital, Gulbarga – by a constant interplay, extending beyond the ruler’s death, between the mausoleum of the sovereign and the *dargāh*, as the seat of religious power and symbol of the union and reciprocal investiture between religious and political authority. In the light of the double role, political and spiritual, acquired by Aḥmad Šāh I, his final resting place – from which he continued to operate for the good of his subjects and especially his devotees – was intended to powerfully convey the ruler’s authority, as well as the distinguishing traits of his identity. The decorations stand as an enduring testimony to the sovereign’s role and to his unique qualities as an elect. The decorative programme designed for these purposes would appear to revolve around the use of a consciously striking language, although its various parts play on an underlying ambiguity. Aḥmad Šāh I, the *walī* and friend of God, is at the same



time a disciple; and although he apparently embraces the teachings of the Ni'matullāhiyya – the lower walls of the mausoleum display the writing of Ni'matullāh himself – and maintains the Sunni beliefs of his predecessors, he now inhabits a mausoleum that, precisely by virtue of an epigraphic programme whose content finds no parallels in the Deccan, comes across as Shi'i in the eyes of many art historians.

In the light of the data which have been collected, it is certainly difficult to unreservedly accept the thesis of Aḥmad Šāh I's adoption of Shi'a Islam. However, the idea commonly found in studies on the Deccan, according to which Aḥmad Šāh I never publicly advertised his adherence to this religious current, would seem to waver in the face of a decorative programme such as that of the mausoleum. Perhaps, the impression one gets when crossing the threshold of the ruler's monument is not of a positive statement of adherence to a given religious persuasion, but rather of an ability to merge the visual languages typically employed in Shi'i and Sufi (Sunni?) contexts: it is as though the sovereign had wished to address each of his subjects in a language he could understand. No doubt, we do not know to what extent visitors to the mausoleum and devotees of the ruler-saint were aware of the discursive power of the decorations. In any case, the ambiguity one finds in the source would appear to extend from the figure of Aḥmad Šāh I – and his body – to his burial place, which through its decorative programme has become an everlasting testimony to the identity of his sovereign, and possibly of his kingdom too.

Moving towards a conclusion, we can expect further clues to emerge through future investigations and comparisons with the above-mentioned buildings related to the mausoleum, in terms of patronage or style, and from a detailed analysis of the sources. For the time being, the decorative programme just illustrated is best regarded as evidence for the attempt to find a – perhaps precarious – balance between the different components of the kingdom which shaped much of Bahmanī history and was destined to play an even more prominent role in subsequent dynastic phases.

## Bibliography

- Allan, James (2012). *The Art and the Architecture of the Twelver Shi'ism: Iraq, Iran and the Indian Sub-Continent*. London: Azimuth Editions.
- Aubin, Jean (1991). «De Kûhbanân à Bidar: la famille Ni'matullāhī». *Studia Iranica*, 20, pp. 233-255.
- Branfoot, Crispin (2007). *Gods on the Move, Architecture and Ritual in the South Indian Temple*. London: The Society for South Asian Studies.
- Coslovi, Franco (1990). «La genesi dei gruppi Mulki e Ghayr-Mulki nel Deccan bahmanide: Il ruolo di Sultan Ahmad Wali Bahmani». In: Amoretti, Bianca Scarcia (a cura di), «Sguardi sulla cultura Sciita nel

- Deccan - Glances on the Shi'ite Deccan Culture». *Rivista degli Studi Orientali*, 64 (1-2), pp. 97-121.
- Curatola, Giovanni (1990). «Un percorso di lettura sulle arti decorative nel Deccan». In: Amoretti, Bianca Scarcia (a cura di), «Sguardi sulla cultura Sciita nel Deccan - Glances on the Shi'ite Deccan Culture». *Rivista degli Studi Orientali*, 64 (1-2), pp. 195-234.
- Eaton, Richard Maxwell (1978). *Sufis of Bijapur 1330-1700, Social Roles of Sufis in Medieval India*. Princeton: Princeton University Press.
- Eaton, Richard Maxwell (2006). «The Rise and Fall of Military Slavery in the Deccan, 1450-1650». In: Indrani, Chatterjee; Maxwell, Eaton Richard (eds.), *Slavery and South Asian History*. Bloomington; Indianapolis: Indiana University Press.
- Eaton, Richard Maxwell (2008). *A Social History of the Deccan 1300-1761, Eight Indian Lives*. Cambridge: Cambridge University Press.
- Fischel, Roy (2014). *Historiography, Sufis, and the Question of Deccani Identity*. Paper presented at the Simon Digby Memorial Conference, SOAS (London, 9-11 June 2014).
- Firishta, Muhammad Qasim (2006). *Tarikh-i Firishta* (Completed in 1611). Trans. by John Briggs under the title *History of the Rise of Mohamedan Power in India, till the Year AD 1612, vol. iii*. New Delhi: Adam Publishers and Distributors.
- Golombek Lisa, Wilber Donald (1988a). *The Timurid Architecture of Iran and Turan, vol. 1, Text*. Princeton: Princeton University Press.
- Golombek Lisa, Wilber Donald (1988b). *The Timurid Architecture of Iran and Turan, vol. 2, Plates*. Princeton: Princeton University Press.
- Green, Nile (2004). «Emerging Approaches to the Sufi Traditions of South Asia: Between Texts, Territories and the Transcendent». *South Asia Research*, 24 (2), pp. 123-148.
- Haidar, Navina Najat; Sardar, Marika (eds.) (2011). *Sultans of the South: Arts of India's Deccan Courts, 1323-1687*. New York: Metropolitan Museum of Art; London: Distributed by Yale University Press.
- Haig, Thomas Wolseley (1924). «The Religion of Ahmad Shah Bahmani». *Journal of the Royal Asiatic Society of Great Britain and Ireland*, 1, pp. 73-80.
- Hardy, Peter (1977). «Firishta», s.v. In. *Encyclopedia of Islam*. 2nd ed., vol. 2, pp. 943-945.
- Khalidi, Umar (1990). «The Shi'ites of the Deccan: An Introduction». In: Amoretti, Bianca Scarcia (a cura di), «Sguardi sulla cultura Sciita nel Deccan - Glances on the Shi'ite Deccan Culture». *Rivista degli Studi Orientali*, 64 (1-2), pp. 5-16.
- Khan, Muhammad Abdul Wali (1964). *Bahmani Coins in the Andhra Pradesh Government Museum, Hyderabad*. Hyderabad: Government of Andhra Pradesh.



- Kumar, Sunil (2014). «Historicising the South Asian Chishtiyya: Contextualising Gesu Daraz's Jawami' al-Kalim and the Making of Sufi Fraternities». Paper presented at the Simon Digby Memorial Conference, SOAS (London, 9-11 June 2014).
- Merklinger Schotten, Elizabeth (1981). *Indian Islamic Architecture: The Deccan 1347-1686*. Warminster: Aris & Phillips.
- Mondini, Sara (2009). «Sultans and Saints Building the City». En: Arízaga Bolumburu, Beatriz; Solórzano Telechea, Jesús Angel (eds.), *Construir la ciudad en la Edad Media = Actas de los Encuentros Internacionales del Medioevo* (Nájera, 28-31 Julio 2009). Logroño: Instituto de Estudios Riojanos.
- Mondini, Sara (2015). «Architectural Heritage and Modern Rituals: The Ahmad Shah Bahmani Mausoleum between Old Political Concerns and New Religious Perceptions». In: Jacobsen, Knut Axel; Aktor, Mikael; Myrvold, Kristina (eds.), *Objects of Worship in South Asian Religions: Forms, Practices and Meanings*. London: Routledge.
- Parodi, E. Laura (ed.) (2014). *The Visual World of Muslim India: The Art, Culture and Society of the Deccan in the Early Modern Era*. London: I.B. Tauris.
- Philon, Helen (2000). «The Mural in the Tomb of Ahmad Shah near Bidar». *Apollo* 152, 465, pp. 3-10.
- Philon, Helen (2012). *Gulbarga, Bidar, Bijapur*. Mumbai: Pictor Publishing.
- Rizvi, Saiyid Athar Abbas (1986). *A Socio-Intellectual History of the Isnā 'Asharī Shī'īs in India*, vol. 1. New Delhi: Munshiram Manoharlal Pub.
- Sherwani, Haroon Khan (1985). *The Bahmanis of the Deccan*. New Delhi: Munshiram Manoharlal Pub.
- Sherwani, Haroon Khan (1990). «Sufi-State Relationship under the Bahmanids (AD 1348-1538)». In: Amoretti, Bianca Scarcia (a cura di), «Sguardi sulla cultura Sciita nel Deccan - Glances on the Shi'ite Deccan Culture». *Rivista degli Studi Orientali*, 64 (1-2), pp. 71-96.
- Siddiqi, Muhammad Suleman (1989). *The Bahmani Şūfis*. Delhi: Idarah-i Adabiyat-i Delli.
- Sikand, Yoginder (2003). *Sacred Spaces: Exploring Traditions of Shared Faith in India*. New Delhi: Penguin Books.
- Speziale, Fabrizio (2013). «À Propos du Renouveau Ni'matullāhī: Le Centre de Hyderabad au Cours de la Première Modernité». *Studia Iranica*, 42 (1), pp. 91-118.
- Speziale, Fabrizio (2014). «The Ni'matullāhī Renewal in the Deccan and the Contrasting Biographical Narratives of Shāh 'Alī Riẓā». Paper presented at the conference *Shi'i Spirituality and Sufi Paths in Early and Modern Times* (Venice, Università Ca' Foscari Venezia, 15 April 2014).
- Yazdani, Ghulam (1995). *Bidar, its History and Monuments*. New Delhi: Motilal Banarsidass Publishers. 1st ed., London: Oxford University Press, 1947.

## **4 Lines of Transition**



## Borders

Itineraries on the Edges of Iran

edited by Stefano Pellò

# Kashmir and the Mughal Fad of Persian Pastoral Poetry

Sunil Sharma

(Boston University, USA)

**Abstract** The annexation of Kashmir by the Mughals resulted in the celebration of the natural beauty and imperial architecture of the valley in a body of Indo-Persian court poetry. Visited by the emperors Akbar, Jahāngīr, Shāh Jahān, and Aurangzeb, Kashmir became a major cultural and literary center in the seventeenth century. Especially in Shāh Jahān's reign, the poet laureate, Kalim Hamadāni (d. 1651), along with a dozen other poets visited Kashmir and composed topographical poems using the *masnavi* form, initiating a literary fad that lasted for over two decades. Although most poems modified the model of the city poem for this purpose, using the same metaphors praising urban spaces that included descriptions of idealized Persian gardens, others produced poems in the pastoral or bucolic mode with realistic descriptions of actual places, the flora and fauna of the region, and praise of life in the countryside. Given their relationship to the empire and land, Iranian and Indian-born poets employed by the Mughal court had differing attitudes to the place of Kashmir in the imperial mosaic. The fad of the Kashmir poem is a previously unexplored episode in the history of seventeenth-century Mughal court culture.

**Keywords** Mughals. Indo-Persian poetry. Kashmir. *Masnavi*.

The cosmopolitan atmosphere of Mughal society was the result of a tremendous zeal for travel and mobility, both on a transnational level and within the early modern empire. The lingua franca Persian unified this vast polity and kept it connected with the world of Safavid Iran, Ottoman Turkey, and Central Asia. The poetic form of the *ghazal* or love lyric was the most accessible means of participating in a unified Persophone literary culture where texts, and even a line of poetry, travelled with amazing speed from Delhi to Isfahan and Constantinople. But when we look at other genres of poetic writings, particularly poems of place that were in vogue in the sixteenth and seventeenth centuries, it is clear that new literary developments were taking place that were tied to a new understanding of the local or regional in a larger geographic framework. Therefore, whereas the *ghazal* was universal, generic, and portable, as were some other poetic forms and genres as well, the corpus of topographical poetry was specific to a time and place. The genre of what Paul Losensky calls «urban-topographical» poetry of this period, mostly composed as *masnavīs*, included

---

### Eurasiatica 5

DOI 10.14277/6969-100-3/EUR-5-8

ISBN [ebook] 978-88-6969-100-3 | ISBN [print] 978-88-6969-101-0 | © 2016

descriptions of imperial architecture, versified travelogues within a region or on a more international level, i.e. between Iran and India. Persian court poets and historians of this period paid special attention to praising the cities that were being built or expanded, its architectural monuments, bazaars and inhabitants, celebrating the here and now (Losensky 2003). This genre was the literary legacy of the earlier Indo-Persian poet Amīr Khusrau's (d. 1325) encomiastic writings on Delhi and of Timurid texts describing Herat and other places.<sup>1</sup> The new found sense of place in the early modern period can be linked to the awareness of the expansion of the literary realm of Persian to include new regions, peoples, and sense of aesthetics. There was a shift in the spatial consciousness of Persian poets who were no longer constrained to describing idealized gardens and assemblies that were suspended in time, but rather wrote about these same spaces in actual time and place.<sup>2</sup>

A special category of Persian topographical poetry flourished in the seventeenth century Mughal court under the emperors Jahāngir and Shāh Jahān that was exclusively devoted to the beauties of the landscape of the Kashmir valley, the northernmost province of the empire and a veritable paradise in popular imagination.<sup>3</sup> The genre of Mughal pastoral poetry describing non-urban spaces commemorated the appropriation of places on the edges of the empire into the imperial domain, combining the traditional praise for buildings and gardens constructed by various members of the imperial family and governors, with the beauty and richness of nature. Thus, along with the rise of poetry about cities, there is an increasing attention given to the countryside using the same tropes and metaphors. From a literary point of view, it is intriguing to explore the emergence of a poetic genre that can be termed 'pastoral', in contrast to the ever popular tropes of idealized spaces and allegorical gardens in Persian poetry. Additionally, from a cultural and historical point of view the appropriation of provincial rural spaces as part of the cosmopolitan capitals offers an alternate way of looking at the centre-periphery and urban-rural binaries. I will attempt to demonstrate that the inscription of Kashmir as paradise in the seventeenth-century Mughal propaganda was conveyed in complex ways. Close readings of some poems in the context of the lives of their

---

1 Amīr Khusrau's *masnavīs*, chiefly *Qirān al-sa'dain* and *Nuh sipihr*, contain such verses. Herat is praised in Muhammad Isfizārī's *Rauzat al-jannāt fī ausāf madīnat-i Harāt*, quoting Amīr Khusrau's earlier poetry on Delhi.

2 In this regard, for actual places as settings of poems, see Pellò 2015.

3 In a similar development in Safavid Iran, the northern province of Mazandaran became a courtly resort: «Shah 'Abbas I conquered the region of Mazandaran near the Caspian Sea in 1596-97 and this area held as much delight for him as did Kashmir for the Mughal emperors Jahāngir and Shāh Jahān» (Tittley, Wood 1991, p. 38). Poetry about Mazandaran, though, did not take on as a literary fad.

authors reveal that the varied descriptions of the province were also linked to personal expressions of attachment to place, as well as being a literary trope that functioned at a metaphorical level to espouse an imperial ideology, and at times, even to draw attention to the cracks in the empire.

Pastoral poetry in a romanticized mode is actually quite rare in classical Persian literature. Found in the Western literary tradition, with its origins in Greek and Latin poetry, the pastoral poem celebrates the pristine countryside, in opposition to the corrupt city, although literary critics such as Frank Kermode and others have argued that this genre in effect indirectly addresses urban issues (*English Pastoral Poetry* 1972, p. 14). According to Brian Lockey, «the challenge of pastoral poetry is that at the same time that it defines its own innocence in relation to an outside corruption, it also furtively undermines the very opposition through which its own purity is constituted» (Lockey 2006, p. 37). The use of nature imagery in Persian literature was so commonplace so as to be trite, but the stylized description of ideal gardens populated with roses and nightingales signifies a system of complex metaphors for a range of courtly and mystical practices, and almost never to be taken as literal representations.<sup>4</sup> In contrast to European pastoral poetry written under courtly patronage, the Persianate ruler is more of a gardener than a shepherd. With Babur, the first Mughal, came the idea that Hindustan is the emperor's garden, as reflected in his laying out of several gardens and ethnographic interest in the flora and fauna of the land (Stronge 2002, p. 88; Koch 2007). During the seventeenth century the terms paradise (*bihisht*, *firdaws*) and paradisaic were employed as stock metaphors for many places, from intimate interior spaces to entire territories. Along with this, I argue, the conception of the empire as an unspoiled Arcadia, where the city and countryside come together harmoniously emerged in Shāh Jahān period Mughal pastoral poetry before being eclipsed by other literary trends.

Even as there was a growing consciousness of the trans-local spread of Persianate culture, writers of both prose and poetic works from the late sixteenth century began to celebrate the local, including regional history and biographies of notables, as if to introduce or integrate it into a larger narrative of Muslim history. Abu al-Fazl's encyclopedic *Ā'in-i Akbarī* (Institutes of Akbar) provides detailed information on the provinces (*sūba*) of the Mughal Empire. Completed in 1592, the *Tabaqāt-i Akbarī* (Ranks of Akbar) by Nizāmuddīn Ahmad departed from the traditional chronicles by including nine sections on the different provinces of the empire. In

4 Julie S. Meisami (1985) provides a thorough treatment of this subject. An extensive bibliography on secondary literature about gardens can also be found there. Meisami argues that Persian poets realizing that the universe's «order is knowable and that knowledge of one aspect will lead to knowledge of the others, they create a varied array of earthly gardens through which to convey their vision of cosmic order» (p. 253). Also see de Fouchécour 1969.

the same year the gazetteer-biographical dictionary, *Haft Iqlīm* (Seven Climes), written by Ahmad Amīn Rāzī in 1593-94 at the Mughal court, dealt separately with the various Muslim states of India as part of a universal narrative of the spread of Perso-Islamic culture. In the early sixteenth century in the Deccan, the historian Firishta's *Gulshan-i Ibrāhīmī* (Rose Garden of Abraham) included the Deccan and other regions, not only to provide the political history of all these provinces, but also their cultural history, in order to give a more complete picture of the centres of Muslim polities in India. Although historical chronicles do not always provide details of the topography of places, they occasionally employ a poetic mode of description, even quoting verses.

Taken over by the Mughals and becoming a province in 1586, Kashmir began to figure as an important place in the imperial imagination of court historians and poets.<sup>5</sup> In the *Ā'in-i Akbarī*, Abū al-Fazl provides both geographical and cultural information about the province, ascribing the Hindus of the valley with positive qualities with simple, pastoral qualities,

The most respectable class in this country is that of the Brahmans, who notwithstanding their need of freedom from the bonds of tradition and custom, are true worshippers of God. They do not loosen the tongue of calumny against those not of their faith, nor beg nor importune. They employ themselves in planting fruit trees, and are generally a source of benefit to the people. They abstain from flesh-meat and do not marry». (Abu 'l-Fazl 1891, pp. 353-354)

The same author's account in the chronicle *Akbarnāma* of the Emperor Akbar's first visit to the valley in 1590, despite being discouraged by the fact that it was nothing but a pit and prison, adds a mystical bent to the newly conquered province:

Since the wonder of destiny increases farsighted thoughts, he was constantly thinking of Kashmir and imagining its delightful climate. When the incomparable deity brought that beautiful region into the imperial realm, it increased the emperor's desire to tour that land of perpetual spring. As much as the chatterers at court represented that it was not wise for a monarch to abandon such a vast expanse and go off to a corner without an important reason of state, the emperor refused to agree, saying, «The divine Bestower gives me no choice in this desire, and furthermore Jannat-Ashyani [Humayun] took this wish to the grave

---

5 Mattoo 1988; Zutshi 2014, esp. Ch. 2: *A Literary Paradise: The Tarikh Tradition in Seventeenth- and Eighteenth-Century Kashmir*, after the political upheavals; she writes, «Mughal rule allowed for a narrative turn towards asserting Kashmir's uniqueness, and hence distinctive position, within the Mughal empire» (p. 73).



with him. Our expedition there will be the fulfillment of his desire». (Abu'l-Fazl 2015-2016, 2)

At the same time, the historian's brother and poet-laureate Faizī (d. 1595) also commemorated the event in a formal victory ode (*qasīda*), representing the process of conquest as a romantic endeavor: «A thousand caravans of desire travel overnight in order to unpack their loads of pleasure in the land of Kashmir» (*hazār qāfila-yi shauq mīkunad shabgīr | ki bār-i 'aish gushāyad bi-'arsa-yi Kashmīr*). The purpose of the endeavour is again tinged with mysticism: «The territory of Kashmir is laid out as if kissing the foot of the [heavenly] throne by way of the divine halo of fate» (*zamīn-i 'arsa-yi Kashmīr z-ānsān guzarānad | bi-farr-i daulat taqbil-i pāya-hā-yi sarir*) (Faizī 1983, pp. 42-47).<sup>6</sup> Akbar is called *murshid* and *pīr* to the people of the land. Faizī makes a reference to the administration of the city in a poetic vein, claiming that if the mountain springs do not gush forth, «an official takes them to the judge of the city, and the inspectors of the province reprimand them» (*agar na muftī-yi ū mīkashad bi-qāzī-yi shahr | kunand muhtasibān-i vilāyatash ta'zīr*). In this way, a Persianate Arcadia was created.

In the early seventeenth century, the emperor Jahāngīr and his chief wife Nūr Jahān, who was of Iranian origin, made Kashmir into a fashionable haunt of the court as a retreat during the summer months. Jahāngīr visited Kashmir more times than any other Mughal ruler, sojourning in the valley in 1607, 1619-20, 1622, 1624, 1625, 1626, and then one last trip in 1627 when he died on the way back to the plains. On a trip to the province in the spring of 1621, while recording an ethnographic description of Kashmir, Jahāngīr lapses into lyrical praise of the land:

Kashmir is a perennial garden and an ironclad bastion. For monarchs it is a garden that delights the eye, and for poor people it is an enjoyable place of retreat. Its lovely meadows and beautiful waterfalls are beyond description. Its flowing waters and springs are beyond number. As far as the eye can see there is greenery and running water. Red roses, violets, and narcissi grow wild; there are fields after fields of all kinds of flowers; and the varieties of herbs are too many to count. During the enchanting spring, mountain and plain are filled with all sorts of blossoms; gateways, walls, courtyards, and roofs of houses come ablaze with tulips. What can be said of the plateaus covered with refreshing clover?

The coquettes of the garden displayed themselves, cheeks adorned, each like a lamp.| Buds give off the fragrance of musk from beneath

<sup>6</sup> Faizī's poem is quoted in the *Haft Iqlīm*, section on Kashmir, 2, p. 618. In the Deccan, Firishta also includes a romantic description of Kashmir, particularly dwelling on its many temples.

their skin, like musky amulets on the arm of the beloved. | The melody of the dawn-rising nightingale sharpens the desire of wine-drinkers. | At every spring a duck puts its beak to drink – like golden scissors cutting silk. | A carpet of flowers and greenery laid out in a garden: the lamp of the rose lit by the breeze. | The violet has twisted the ends of her locks, tying a tight knot in the heart of the rosebud. (Thackston 1999, p. 332)

This poetic outburst innovatively combines a bucolic mode of description mixed with the conventional garden imagery of classical Persian literature, and thus is a precursor of a special kind of nature poetry genre that would develop in the following two decades.

Jahāngīr's Persian wife, Nūr Jahān, has been credited with making Kashmir a regular destination in the itinerary of the imperial court «which under her guidance travelled increasingly for leisure's sake» (Findly unpubl. and 1993). This tradition would continue for at least the next half century. Nūr Jahān also helped to develop the handicrafts industry and creating a vogue for Kashmiri embroidery and shawls. Several palaces and gardens were built in and around Srinagar by her and other members of the extended imperial family, such as the gardens of Verinag and the terraced Shalimar Bagh. Jahāngīr's Iranian-born poet-laureate, Tālib Āmulī (d. 1526-27),<sup>7</sup> who must have accompanied the emperor to Kashmir on one of his trips was the first Mughal poet after Faizī to compose poems on the pristine beauty of the valley; he produced two *qasīdas* extolling the natural wonder of the place along with praise of the ruler; one poem opens with the line: «Traversing the difficult way to Kashmir has become easy by the fortune of the Emperor Jahāngīr» (*shud āsān tay-i rah-i dushvār-i Kashmīr | bi-iqbāl-i shahanshāh-i Jahāngīr*).<sup>8</sup> These poems are undisguised imperial propaganda and do not contain detailed poetic ethnographies of the land, nor are they the verse travelogue genre of poems that would come into vogue in the following decades. But there are already elements present here that would become a regular feature of the genre, such as a partial list of gardens in Kashmir and a catalogue of its fruits. The aim of these poets was to praise Jahāngīr and Kashmir provides the exordium for launching into panegyric: «There is spring all year because it is not permissible for the world to deviate from the rectitude of your justice» (*tamām-i sāl bahār ast zi ānki nīst ravā | zi istiqāmat-i 'adl-i tu jahān taghyīr*). But it is really under the next ruler, Shāh Jahān, and his children, Dārā Shikoh and Jahānārā, who had close connections to the Qadiriya Sufi order of Panjab and Kashmir, that poetry on this province flourished as a full-fledged genre of its own.

7 For an overview of the poet's life and works, see Losensky 2004.

8 Tālib-i Āmulī 1967; the two poems are on 1000-05 and 1005-09.

Shāh Jahān made four trips to Kashmir, in 1634, 1640, 1645 and 1651 during his thirty-year reign. The summer of 1634 trip took place three years after the death of Mumtāz Mahal. Kashmir was the ideal change of scene for Shāh Jahān. Many of the courtiers had accompanied him, of course, including the two poets, Kalīm and Qudsī, who were probably visiting the province for the first time. Since propaganda for Shāh Jahān exploited the use of botanical imagery, as in Agra's riverfront garden city, *pietre dure* floral motifs in architecture, and ornamentation in manuscripts, it was natural that his court would be drawn to the possibilities that the Kashmiri landscape offered. The art historian Ebba Koch explains, «The image of the garden and its flowers was the main metaphor of Shāh Jahān's imperial symbolism: it stood not only for the emperor himself and his good government but also for his court and his family».<sup>9</sup> Floral images are found on so many objects in Mughal art and architecture, just as the metaphors of garden and paradise applied to every place in Persian historical and poetic texts of this time, that one is necessarily overwhelmed by their clichéd connotations. But in the age of Shāh Jahān, these had all gained subtler and more complex meanings.

Kashmir quickly became the favourite subject of Persian court poets because it came closest to the idealized Persian garden and paradise that appears as a metaphor in classical poetry. During Shāh Jahān's reign, it also became an important literary centre for poets from the Mughal court, locals, and Iranian itinerant literati who visited the place or settled there. Even more than the imperial family, it was one man who provided the patronage and created a hospitable atmosphere for poets: the Mughal governor Zafar Khān (d. 1662), himself a poet who used the *takhallus* 'Ahsan'. Son of Khvāja Abū al-Hasan of Turbat, governor of Kabul, then Kashmir, and married to the granddaughter of Nūr Jahān's brother, Zafar Khān took over the governorship of Kashmir for seven years (1632-1640), then later for another four years.<sup>10</sup> Under him several major poets of the time congregated there: such as the Iranians Kalīm Hamadānī, Salīm Tihriānī, Qudsī Mashhadī, Tughrā Mashhadī, Sā'ib Tabrīzī, Bihishtī Haravī, to name a few, and the Indian-born Munīr Lāhorī (d. 1644), two local Kashmiri poets, Fānī and Ghanī, who are more firmly enshrined in the local memory, and even the Sufi Mullā Shāh Badakhshī was at the fringes of this courtly group.<sup>11</sup>

9 Koch 2006, p. 224. This metaphor was particularly exploited in the ornamental decoration in the Taj Mahal since the monument was supposed to evoke the idea of paradise.

10 Zafar Khan Ahsan 1985, pp. 15-50. His other poems, chiefly *ghazals*, have also been published: Zafar Khān Ahsan 1976.

11 According to the historian Aziz Ahmad (1976), «Patronage of poets was a status symbol for a cultivated Mughal nobleman, and the expense incurred was well-justified in his view, since his mansab [rank] and estate was not hereditary; he tried to spend his wealth as lavishly and as elegantly as possible during his lifetime» (p. 125).

Below is a list of Mughal poets who wrote one or more poems on Kashmir.<sup>12</sup>

Poet	In the reign of
Faizī	Akbar
Tālib Āmulī	Jahāngīr
Kalīm Kāshānī	Shāh Jahān
Qudsī Mashhadī	Shāh Jahān
Salīm Tīhrānī	Shāh Jahān
Zafar Khān ‘Ahsan’	Shāh Jahān
Mullā Shāh Badakhshī	Shāh Jahān
Munīr Lāhorī	Shāh Jahān
Sālik Qazvīnī	Shāh Jahān
Bihishtī Haravī	Shāh Jahān
Saidī Tīhrānī	Shāh Jahān
Fānī Kashmīrī	Shāh Jahān
Mullā Tughrā	Shāh Jahān
‘Ināyat Khān ‘Āshnā’	Shāh Jahān
Jūyā Tabrīzī	Aurangzeb ‘Ālamgīr
Bīnish Kashmīrī	Aurangzeb ‘Ālamgīr
Nāsir ‘Alī Sirhindī	Aurangzeb ‘Ālamgīr

An autograph manuscript of Zafar Khān’s three connected *masnavīs* describing the Mughal gardens in and around Srinagar, now in the Royal Asiatic Society, London, includes paintings by the artist Bishandās that depict some of the Mughal gardens of the valley. The emphasis is on the courtly figures using these spaces, but the natural world is never far from the manmade structures.<sup>13</sup> The intersection of imperial patronage and personal attachment on Zafar Khān to this place resulted in a distinct visual representation of the local topography that does not exist for any other Mughal province.

<sup>12</sup> This is not meant to be an exhaustive list since not all poems have been published. All the poems except the ones by Fayzī and Tālib are in *masnavī* form, and Mullā Tughrā has several works on Kashmir in both prose and poetry. Also, the Kashmir poems by Sālik and Bihishtī are part of longer narrative works. Many of these poets and selections from the poems are included in *Tazkira-yi shu‘arā-yi Kashmir* (Rashidi 1967-1969). There do not appear to be any similar poems in Mughal Hindi texts, as far as I know. Audrey Truschke (2016) discusses a short Sanskrit work, *Āsaphavilāsa*, by the poet Jagannātha, which would have been written in the 1630’s. *Āsaphavilāsa*, is a prosimetrum panegyric piece in praise of the Mughal officer Āsaf Khān, who accompanied Shāh Jahān to Kashmir on one of his visits. Jagannātha praises the beauty of the region and the Himalayas along with his patron. Although it is unclear whether the subtleties of the composition were appreciated by Āsaf Khān or other nobles, it was almost certainly written in response to the Kashmir-mania among Persian court poets. For Kashmir in pre-Islamic Sanskrit texts, see Inden 2008, pp. 523-547.

<sup>13</sup> The paintings from this manuscript were first published by Pinder-Wilson (1957, 1989).

A close reading of three poems on Kashmir will illustrate how the topic signified differently for Iranian and Indian Mughal poets. One of the most famous of these poems, and one that would have been emulated by all later poets, was composed by Kalīm, who spent his early life in Iran before building his professional career in the Deccan, and finally at the Mughal court.<sup>14</sup> He retired to Kashmir at the end of his life and died there. Kalīm wrote two topographical poems in *masnavī* form of roughly equal length: one on Akbarabad (Agra) (236 lines), and the other on Kashmir (188 lines); the former has been studied more extensively than the latter. In his poem on Akbarabad, Kalīm takes the reader on a panoramic tour of the capital city, describing its monumental architecture, bazaar and a garden. A section of the poem is in the *shahrāshūb* mode, listing a sampling of young professionals in the bazaar, as well as social groups such as Shaikhs, Rajputs and Pathans.<sup>15</sup> After praising the cosmopolitan nature of the city and the busy marketplace, Kalīm expresses his amazement of the river Yamuna (*Jaun*), the boats on it and lofty buildings alongside it. During his time, visitors travelling to Agra by boat would have had a stunning view of this magnificent garden city built along both sides of the river (Koch 2008). Kalīm describes this wondrous sight: «A city on two sides and the river in between; on the seashore, [but] a sea without shore» (*du jānib shahr u daryā dar miyāna | kinār-i bahr, bahr-i bī-kirāna*), and he invites the reader to take a ride on the river to relieve the mind of sorrow. The rest of the poem is devoted to a garden which contains specifically Indian flowers such as *champā*, *maulsri*, and *keorā*, along with the usual narcissus and tulip, presenting a harmonious blend of the Indic and Persian natural worlds. In the end, Kalīm declares that although the previous owner of the garden, the emperor's late wife Mumtāz Mahal, is in paradise (*jannat*), she left *this* paradise to her daughter Jahānārā. Kalīm's poem was meant to highlight the magnificence of the Mughal capital, and its Indo-Persian garden for a Persophone audience beyond the limits of the Mughal domain. In his verses nature complements the cityscape and is contained within a walled garden in the city, with everything in its proper place.

Kalīm used the same basic tropes and images in his poem on Kashmir, a rhapsodic paean to the special status of the valley in the empire, compared to the rest of the subcontinent. At the beginning of the poem, Kalīm has an epiphany that Kashmir is more than just a garden: «I spoke in error: not just a fragrant garden or rose garden; | it is the abode of spring, a place of beauties, a paradise» (*ghalat guftam – chi būstān u chi gulzār*

<sup>14</sup> For an introduction to Kalīm's life and works, see Meneghini 2004. Wheeler M. Thackston's unpublished dissertation on the poet, *The Poetry of Abū-Tālib Kalīm, Persian Poet Laureate of Shāhjahān, Mughal Emperor of India* is a valuable resource.

<sup>15</sup> Abū Tālib Kalim-i Kāshānī 1990, pp. 142-151. For the genre of *shahrāshūb* and a more detailed discussion of this poem, see Sharma 2004.

| *bahāristān, nigāristān, iram-zār*) (Abū Tālib Kalim-i Kāshānī 1990, pp. 174-181). The climate here is its most enticing feature, with no sign of the hot summer of the plains, and the clouds in the sky like a lover roaming in his beloved's lane. The topography of this land is so unique that it is garden, sea, and city, all at once. The term Kashmir at this time referred to both the province and city, a deliberately blurring the division between the urban and rural spaces. Employing clever puns and rhetorical figures, Kalīm takes note of the two main bodies of water here: Bahat (Jhelum river), like the Nile, and the other Lake Dal, that makes one's heart (*dil*) restless. He then invites the reader to take a ride on the water, as he had done in his Agra poem: «Come for a trip on the Dal, what is a rose garden? Collect flowers on a boat, what is a skirt» (*bi-sayr-i Dal biyā, gulshan chi bāshad?* | *bi-kishtī gul bibar, dāman chi bāshad?*). As Kalīm becomes the guide on the boat, he is struck by the fact that this is a garden of paradise on a green sea. The lotuses on the water (*kaval*) are like the lips of a beloved red with chewing betel-leaf (*pān*) and plucking them is like applying henna to one's hands!

Specific sites that are visible from the lake are pointed out: Takht-i Sulayman (the hill in southeast Srinagar where the Shankaracharya Temple is located), the gardens of Bahrara, 'Ayshabad, Farahbakhsh (Shalimar), the royal canal, and the Nishat garden with its lofty buildings that match the mountains behind it and its nine fountains (Thackston 1996). At one point Kalīm exclaims that with so many gardens in this country, he does not know in which one he can be a nightingale! Nature here is all contained within the limits of the city and lives in harmony with man-made architecture and is both wild and cultivated (see Losensky 2015; Meisami 2001, pp. 21-54). The last quarter of the poem is a panegyric to Shāh Jahān who is praised for his just rule and his support for upholding Islam in India. He is the refuge of the seven climes (*panāh-i haft kishvar*) for those who have given up hope, and he takes the hand of those who have been knocked over by fate. Kashmir is only a patch in the garden of his temperament, while the fingers of his hand are the five rivers of Panjab that irrigate the world. Kalīm ends with a benediction on Kashmir:

*bi-khūbī tā shavad Kashmīr mazkūr | bi-'ālam nām-i nīkash bād*  
*mashhūr*  
*kunad daryūza kūh-i Pīr Panjāl | zi chatr-i daulatash rif'at hama sāl*

As long as Kashmir is mentioned with good words, may it be  
renowned in the world.  
 The Pir Panjal mountain seeks elevation from the parasol of his  
fortune, all year.

With this reference to the mountain range in the last line, the poet leads

the reader to the way back to Hindustan. Kalīm used the template from his poem praising Agra and applied it to Kashmir, with a few topographical specificities. Though he is moved by the natural wonder of the valley that threatens to outdo the imperial structures, his poetry is mannered and informed by an older tradition of Persian gardens. In his view as a professional panegyrist, Agra and Kashmir were equivalent spaces to showcase the Mughal Empire's greatness. The polished nature of Kalīm's language and the controlled he has over the narrative suggests that he is performing his role as poet laureate for the court or the larger Persophone world.

In contrast, Indian born poets wrote about Kashmir using the same literary devices as their Iranian counterparts, but in a more novel and personal way. A somewhat elusive figure in his own times, and almost forgotten in ours, Abū al-Barakāt Munīr Lāhorī (1610-44) was a poet of Shāh Jahān's court (Memon 1983). In 1635 Munīr entered the service of Mīrzā Safī Saif Khān, governor of Akbarabad (Agra) and brother-in-law of the empress, Mumtāz Mahal. After his patron's death in 1639, Munīr joined the court of I'tiqād Khan, the governor of Jaunpur but soon returned to Agra where he died young. Munīr wrote wistfully about being isolated in an Iranian-dominated literary circle at court and expressed an attachment to his place of origin. In one of his works he named five luminous personalities who have emerged from the land of India: Mas'ūd Sa'd Salmān and Abū al-Faraj Rūnī from Lahore, [Amīr] Khusrau and Hasan from Delhi, and Faizī from Nagor, thus providing what is the first literary canon of Indo-Persian poets and one linked to geography (Abu'l-Barakāt Munīr Lāhorī 1977, pp. 27-28).

A poem on Kashmir by Munīr is the *Masnāvī-yi bahār-i jāvīd* in 1337 lines (Abu'l-Barakāt Munīr Lāhorī 2009, pp. 195-227), considerably longer but which shows clear influences of Kalīm's poem. The phrase «eternal or perennial spring» is the same that both Abū 'l-Fazl and the emperor Jahāngīr used to describe this land. The poem is dedicated to I'tiqād Khān Shāpur Mīrzā, brother of the dowager empress Nūr Jahān, who had been governor of Kashmir under Jahāngīr. It does not bear a date but was probably written at the end of the poet's short life. In a section on the reason for the composition of this work, Munīr employs a conventional device explaining that a beautiful creature visited him with a command to write the poem. Munīr boasts that will be the nightingale in the garden of Kashmir and write in the style of the masters Qudsī and Kalīm. He also states early on that he will describe the garden, mountains, and city (*numūdam husn-i bāgh u shahr-i ū rā | sutūdam dasht u kūh u bahr-i ū rā*), bringing all these places together under his poetic gaze. Beginning with praises for the paradise-like quality of Kashmir, Munīr describes the city of Kashmir (Srinagar) as the envy of Isfahan, Shiraz, Kabul, and Constantinople. He marvels that every street of this city is filled with beautiful people (*bi-har kūcha-yi nigār-parvar | ki bi-shikasta kalla az nāz bar sar*). Then, as Kalīm had done before him in his Akbarabad poem, he goes on to list a series



of professionals engaged in different occupations who represent the best qualities of the city: *bāzdār* (falconier), *kamāngar* (archer), *najjār* (carpenter), *bazzāz* (grocer), *sārbān* (camel driver), *murdashūy* (washer of corpses), *saqqā* (water-carrier), a list that is somewhat different from the one included by Kalīm. Munīr then launches into the natural beauty of the province, its cold but invigorating climate, the charming wooden houses, and even musical instruments such as the sitar and *vīnā*. In terms of the geographical topography of the province, the impressive Pir Panjal range is next on his list, followed by specific mountains such as Koh-i Maran (Hari Parbat). In fact, the mountain in its loftiness is like a city rather than a village (*ki shahrī hast nabuvad rustāy*); Kashmir is proud of this bounty and the world is exalted next to it. After the mountains, Munīr describes the flowers and lakes of the valley. The endless beds of flowers on land and water are likened to army troops. The lotus flower (*kaval*) is his particular favourite, and the riot of colour on the surface of the lake makes him think that it has eaten *pān*. The boats on the lake are described next and compared to water fowl, who are in a precarious state because they must bear the weight of the handsome boatmen. The poet mentions the Safapur *tālāb*, most likely the Manasbal Lake, because in the present time Safapur is known as a village in the Jhelum valley near Srinagar and famous for its lotuses on the lake.<sup>16</sup> Munīr does not describe buildings in his poem, and there were several in this area constructed under the patronage of the Mughals, only picking out natural formations to bestow praise on, in contrast to other Mughal poets writing on Kashmir who had a preference for architectural monuments.

Gardens are on Munīr's list of topographical features of Kashmir, his list in this respect being the same as that of Kalīm. His first choice is the Shalimar garden, located on the northeast portion of Dal Lake, and what was once the residence of Jahāngīr and Nūr Jahān when they summered in the valley. The description of the gardens of Farahbakhsh (Shalimar) with its flowers, Nishat with its fruits, Bahrara with its chinara trees, is followed by that of 'Aishabad. The avenues in the gardens make him think of streets (*khiyābān*) in a city, and he also uses the bazaar metaphor for the thick foliage. A saffron field and the royal canal, along with some verses on a fountain and waterfall complete the picturesque nature of the landscape.<sup>17</sup> The Takht-i Sulaiman hill draws praise from him although Munīr does not mention the temple there. Sindh Brari, i.e., the Sindh Valley in

16 Ebba Koch's forthcoming article *The Bagh-i Safa alias Jharoka Bagh in Kashmir: The Garden of Princess Jahanara on the Manasbal Lake* retrieves the history of this garden.

17 All these gardens, as well as the royal canal, are mentioned in some detail by the two major historians of Shāh Jahān's reign, Lāhorī in his *Pādshāhnāmah* and Kambo in his *'Amal-i Sālih*. Some of the poetic descriptions are matched to the ones done by historians by Thackston.

the north of Srinagar that leads to the Zojila pass into Central Asia, where the renowned Sonamarg (Golden meadow) is located, is the last item on his list of topographical features. In the end Munīr compares his verses to a cypress in a garden and the lines in his notebook to a street or road (*khiyābān*). The very last line is: «In the rose garden of poetry there are a hundred tulip gardens; there is spring, there is spring, there is spring» (*bi-gulzār-i sukhan sad lālazār ast | bahār ast bahār ast u bahār ast*), being reminiscent of the oft-quoted line applied to Kashmir in this period: «If there is a paradise on earth, it is this, it is this, it is this» (*agar firdaws bar rū-yi zamīn ast | hamīn ast u hamīn ast u hamīn ast*). Whereas Kalīm had ended his poem with the Pir Panjal mountain range, Munīr takes us right through this meadow in a natural setting to the northernmost limit of the empire. Munīr also composed a *masnavī* on another border province, Bengal, where he had a similar reaction: «Everywhere you look there is lush greenery; there is spring, there is spring, there is spring» (*har jānib ki bīnī sabzazār ast | bahār ast u bahār ast u bahār ast*), repeating the phrase he employed in his Kashmir poem. But in the Bengal poem he goes further in bringing the world of untamed nature into his poetic gaze, exemplifying the full flowering of the Mughal pastoral genre (Abu'l-Barakāt Munīr Lāhorī 2009, pp. 148-191). There are no formal gardens that are usually at the centre of the genre of Mughal topographical poetry, rather the attention is fully on the natural environment: from the flora and fauna, climate, topography, using a poetic ethnographic narrative style. But let us return to the Kashmir poems under discussion.

In fact, for some poets the theme of the crossing of the Pir Panjal, usually a preamble to the panegyric sections, became more central than the destination itself. Paul Losensky (unpubl.) writes in connection with the poet Jūyā Tabrīzī's handling of this theme: «As an antithesis of structured social space, the mountain provides a setting where mundane cultural values can be questioned and transcended». In his essay *The Real Arcadia*, the historian Garry Willis writes about the phenomenon of 'mountain dissociation' during his travels in the region of Arcadia in modern Greece. He explains:

The religious experience of these mountains is what is most essential to Arcadia and most absent from Arcadian poetry. This is the land of the sublime, which is always a bit scary, not of the beautiful, which tends to be sedate. The pastoral landscape is what the Romans called *locus amoenus*, an 'agreeable place' ... But Arcadia does not accommodate. It challenges. You are disoriented here on Mount Aphrodisium, the necessary preliminary to reorientation in the rituals that were once performed in such out-of-the-way and hard-to-reach places. (Willis 2003, p. 119)

In the case of Kashmir, the mountainous journey is the major challenge.

Once the mountains are crossed, a Shangri-La awaited the traveler. Nature in the valley is carefully cultivated by the Mughals, and the mountains that one regards from a boat on the Dal or even close up in a garden are integrated into the space of the empire. For this reason, in several poems there are frequent references to Khizr, the guide of the perplexed and lost traveler, to safely convey one to the valley.

A shift in the poetic genre of the Kashmir poem is seen in a poem by Muhammad Muhsin Fānī Kashmīrī (d. 1670-71) that presents more sinister aspects of the mighty empire in the twilight years of Shāh Jahān's reign. Fānī had been in Mughal service in Allahabad as a judge (*sadr*), then went into forced retirement after a scandal during the Balkh campaign of 1646-7 that was meant to conquer the Mughal ancestral lands (Qasemi 1999). At one time, Fānī was thought to be the author of the *Dabistān-i mazāhib*, the valuable encyclopedia of religions of the time. Fānī's Kashmir poem, entitled *Maikhāna* (Tavern) was composed in 1655 and dedicated to his Chishti Sufi master Shaikh Muhibullāh Allāhābādi (d. 1648).<sup>18</sup> This poem, slightly shorter than Munīr's work, is in the genre of a *sāqīnāma*, an address to a young wine server. Losensky's recent study on such poems notes that «the quest for self-identity enacted in the *sāqī-nāma* also opened the genre to more personal concerns and further modes of symbolic immortality» (2014, p. 148). Fānī's poem is explicitly localized and mystical at the same time, though he is also conscious of the requisite formal elements in this by now fully established Kashmir poem genre. Fānī mentions the same gardens that Munīr did, but then adds that comparing the garden of the king, Bāgh-i Shāh, the Chashmashahi garden of today that was a gift from the emperor to his favourite son Dārā Shikoh, to them is like comparing a house to a Sufi lodge (*az in bāghhā bih buvad bāgh-i Shāh | ki farqast az khāna tā khānaqāh*). Fānī also mentions Dārā Shikoh in connection with this garden and natural spring; in fact, they both shared a serious commitment to Sufism and attachment to Shaykh Muhibullāh. A temple is described, which could possibly refer to the Mamal Shiva temple at Pahalgam, where Fānī offers his prayers (*namāz*) in a blasphemous gesture. Whereas Munīr following Kalīm had listed some skilled young tradesmen engaged in different occupations to people their cityscape, Fānī picks a *pān*-seller to represent the populace of Kashmir, as an Indo-Persian equivalent to the shepherd in the European pastoral poem:

*furūshad bi-jān bīra pān-furūsh | chu ū hīchkas nīst arzān-furūsh  
dukān rā chunān basta ā'in zi pān | ki chūn āsmān ast sabz ān dukān ...  
chu tīflān girifta bi-kaf ān javān | kitāb-i Gulistān zi awrāq-i pān ...*

18 Selections from the poem are included in the anthology by Gulchīn Ma'ānī 1980, pp. 327-362; it was also published separately in *Masnaviyāt-i Fānī Kashmīrī* (Muhsin Fānī 1964, pp. 147-218).

The *pān*-seller sells *pān* for the price of life – and no one sells so cheaply!  
He has set up his shop in such a way with *pāns* that it is green like the sky.  
The young seller holds the *pāns* like children holding the *Gulistān*.

This is followed by praise for sugarcane, and then, in a nostalgic vein he makes a somewhat abrupt shift in setting, ruminating about Payag (Prayag, Allahabad) which brings tears like the spring of Verinag in Kashmir to his eyes. He romanticizes over the confluence of the two holy rivers in Payag, Ganga and Yamuna, which seem to him like two whales facing each other as the city of Allahabad floats over the waters. He compares its gardens to those of Kashmir and recalls the neighbourhood of Khuldabad in Allahabad as the best place and a veritable *gulzār-i jannat* (rose-garden of paradise). He writes that every year people gather in this town like deer in a plain, referring to the annual Hindu pilgrimage-fair, the mini-*kumbh melā*:

*hama ahl-i ān shahr daryā-dil and | bi-daryā-yi ma'nī chu mā vāsil and  
zi faiz-i daryā-yi 'ilm u 'amal | hama yāfta ābrū az azal*

The people of that city are generous and connected to the sea of  
knowledge like us.  
From the bounty of the sea of knowledge and deeds, they have all  
obtained honour.

Then follows praise for his Sufi master and some autobiographical statements. At the end of the poem, in another turnaround, Fānī lapses into a mystical reverie and begins to exhort his readers about morally correct conduct in these dark times. He paints a horrific picture of a dystopia where virtue is absent and vice reigns supreme. In such a place instead of doing their respective occupations, everyone busies himself with some other wanton activity. The king with his crown resembles a rooster, the *shaikh* robs the innocent like Satan, the *qāzī* takes bribes, the people are occupied in drunkenness and debauchery. Religion remains the only refuge for good men. Fānī's extremely somber tone is in contrast to the earlier exuberance of the poem, but as someone who is no longer part of the Mughal imperial administration, he can choose to not leave the reader in a paradise-like Kashmiri garden but remind them of loftier spiritual and religious truths. Fānī's poem displays a concern about the moral welfare of the world, and given his association with the Mughals, its political subtext cannot be ignored. Kashmir may still be the pristine countryside for him, but it was no longer a microcosm of the Mughal Empire.

The literary fad of the Kashmir poem lasted until the early years of the Emperor Aurangzeb 'Ālamgīr's reign (r. 1658-1707). The aforementioned Zafar Khān's son, Muhammad Tāhir 'Ināyat Khān 'Āshnā' (d. 1670-71), superintendent of the royal library at the very end of Shāh Jahān's reign

and author of one of the many chronicles of this period, composed a rather insipid short *masnavī*, «On the description of the mountain road to Kashmir». Āshnā just could not match up to being a poet of his father's caliber and his poem is actually part of a cluster of loosely connected topographical poems followed by several others: on the House of Mirrors (*Ā'īnakhāna*) in Lahore, on the Sulaiman mountain, Dal lake and the lotus, on various buildings and a garden, and praise of Shahjahanabad (Delhi).<sup>19</sup> Another minor poet in the last years of Shāh Jahān, Sayyid 'Alī Saidī, who was a Mughal of Iranian origin and died young in Delhi, left an incomplete poem on Kashmir (Saidī Ṭihirānī 1985, pp. 61-67), in addition to three other short poems on the gardens of Sahibabad, Shalimar, and Faizabad. Choosing brevity over what had become a florid genre, Saidī advises his readers: «Poetry describing Kashmir is out of place; shut your mouth here and open your eyes» (*sukhan dar vasf-i Kashmīr ast bījā | zabān īnjā bi-band u dīda buḡshā*). But by this time the court was no longer going for regular sojourns to the valley and Mughal poets were only left to imagine this fabled paradise, inscribing it as a mythical place in their verses.

Kashmir with its cypresses and beauties lent itself perfectly to being the ideal garden of Persian poetry. At one level, its neatly laid-out and serene gardens represented the taming of nature and the countryside, on another level it was as an allegory for the flourishing empire. For some poets such as Munīr and Fānī, it was the refuge from the heart of the bustling but corrupt urban centers. The literary fad of writing poetry about Kashmir, and to some extent about other provinces, in the pastoral mode peaked in Shāh Jahān's early years and then faded away like the memory of the imperial court's visits to the valley. Although many of the poems on the praise of provinces, starting from Faizī's *qasīda* on Kashmir and all the way to Kalīm and Munīr, were composed under courtly patronage to celebrate the expansion of the empire, the personal investment and attachment of individual poets to certain places redefined the literary geography of Mughal Persian literature. Munīr was from Lahore and took great pride in following in the footsteps of the great Indo-Persian poets from his city and those of Delhi; he found similarities between the wild idyllic landscape of Kashmir and natural wilderness of Bengal, indicating that there was a more personal investment and individual programme of representation behind his poems. Fānī was originally from Kashmir but fondly recalled his time in Allahabad, meditating on his checkered career in the Mughal administrative network. Nature was liberating for these poets, whether in a courtly and mystical setting, but for Munīr it opened up his world and provided a freedom that allowed him to celebrate the expansion of the

---

19 The unpublished manuscript has the shelf-mark Ethe 1584, Herman Ethé, *Catalogue of Persian Manuscripts in the Library of the India Office* (Oxford: H. Hart, 1903), v. 1, pp. 866-867.

Persian language and poetic parameters, while for Fānī it was a refuge from the wickedness of the material world.

Whereas in Western pastoral poetry the simple life of the shepherd or country dweller is often idealized, in Fānī's poem, a humble tradesman, a *pān*-seller, assumes this role, and praise is reserved for the poet's Sufi master rather than for the emperor. Claiming a rural space as urban as some of our poets do in their poems may seem contrary to the basic definition of pastoral poetry, but this is precisely the distinctive way in which this genre developed during the reign of Shāh Jahān, as an extension of poems about cities. These literary works should not be taken merely as indicative of a nascent regional identity or pride, but as a sophisticated development in a literary tradition that was nurtured by certain ritual journeys of the Mughal court that were orchestrated in poetry by the best poets of the court – such as the frequent trips to Kashmir or travelling down the Ganga or Yamuna by boat – and the complex patronage and administrative system that facilitated this mobility. Especially in the case of Kashmir, in the post-Shāh Jahān period when the province lost its prominence, it nevertheless came to be inscribed in the artistic imagination in a romantic mode. Nature in an idealized form had always been paramount in Persian literature, and in Mughal Persian poetry it was particularly idealized by a group of innovative poets as the 'true' paradise of which the urban world was a pale reflection.

## Bibliography

- Abu 'l-Fazl (1891). *The Ain-i Akbari*, vol. 2. Transl. by H.S. Jarrett. Published by the Asiatic Society of Bengal. Calcutta: Baptist Mission Press.
- Abu'l-Fazl (2015-2016). *The History of Akbar*. 2 vols. Ed. and trans. by Wheeler M. Thackston. Cambridge: Harvard University Press. Murty Classical Library of India 2, 6.
- Ahmed, Aziz (1976). «Safawid Poets and India». *Iran*, 14, pp. 117-132.
- de Fouchécour, C.-H. (1969). *La description de la nature dans la poésie lyrique persane du XIe siècle, inventaire et analyse des thèmes*. Paris: C. Klincksieck.
- English Pastoral Poetry* (1972). *English Pastoral Poetry from the Beginnings to Marvell: An Anthology*. Ed. Frank Kermode. New York: Norton.
- Faizī (1983). *Dīvān*. Ed. by A.D. Arshad. Lahore: Punjab; Tihṛān: Furūghī, 1362.
- Findly, Ellison (unpublished). *Nūr Jahān and the Idea of Kashmir*.
- Findly, Ellison (1993). *Nur Jahan, Empress of Mughal India*. New York: Oxford University Press.
- Gulchīn Ma'ānī, Ahmad (1980). *Tazkira-yi paimāna, dar zikr-i sāqīnāma-hā va ahvāl u āsār-i sāqīnāma-sarāyān, zail-i tazkira-yi maikhāna*. Mashhad: Dānishgāh-i Mashhad, 1359.



- Inden, Ronald (2008). «Kashmir as Paradise on Earth». In: Rao, Aparna (ed.), *The Valley of Kashmir: The Making and Unmaking of a Composite Culture?* New Delhi: Manohar.
- Kalim Kāshānī, Abū Tālib (1990). *Dīvān-i Abū Tālib Kalīm Hamadānī*. Ed. by Muhammad Qahramān. Mashhad: Āstān-i Quds-i Razavī.
- Koch, Ebba (2006). *The Complete Taj Mahal and the Riverfront Gardens of Agra*. London: Thames and Hudson.
- Koch, Ebba (2007). «My Garden is Hindustan: The Mughal Emperor's Realization of a Political Metaphor». In: Conan, Michael (ed.), *Middle East Garden Traditions, Unity and Diversity: Questions, Methods and Resources in a Multicultural Perspective*. Washington, DC: Dumbarton Oaks Research Library and Collection, pp. 159-175.
- Koch, Ebba (2008). «Mughal Agra: A Riverfront Garden City». In: Jarryusi, Salma (ed.), *The City in the Islamic World*. Leiden: Brill, pp. 555-588.
- Koch, Ebba (forthcoming). «The Bagh-i Safa alias Jharoka Bagh in Kashmir: The Garden of Princess Jahanara on the Manasbal Lake».
- Lockey, Brian C. (2006). *Law and Empire in English Renaissance Literature*. Cambridge: Cambridge University Press.
- Losensky, Paul (2003). «The Palace of Praise and the Melons of Time: Descriptive Patterns in 'Abdī Šīrāzī's *Garden of Eden*». *Eurasian Studies* 2, pp. 1-29.
- Losensky, Paul (2004). «Tāleb Āmoli», s.v. [online]. In: *Encyclopaedia Iranica*. Available at <http://www.iranicaonline.org/articles/taleb-amoli> (2015-12-01).
- Losensky, Paul (2014). «Vintages of the *Sāqī-nāma*: Fermenting and Blending the Cupbearer's Song in the Sixteenth Century» [online]. *Iranian Studies*, 47 (1), pp. 131-157. DOI 10.1080/00210862.2013.825503 (2015-12-01).
- Losensky, Paul (2015). «'Square Like a Bubble': Architecture, Power, and Poetics in Two Inscriptions by Kalīm Kāshānī». *Journal of Persianate Studies*, 8 (1), pp. 42-70.
- Losensky, Paul (unpublished). *Portraits of Pir Panjal: The Semiotic Range of Mountains in Classical Persian Poetry*.
- Mattoo, Abdul Majid (1988). *Kashmir under the Mughals, 1586-1752*. Srinagar: Golden Horde Enterprises.
- Meisami, Julie S. (1985). «Allegorical Gardens in the Persian Poetic Tradition: Nezami, Rumi, Hafez». *International Journal of Middle Eastern Studies*, 17 (2), pp. 220-260.
- Meisami, Julie S. (2001). *Islamic Art and Literature*. Princeton: Markus Wiener.
- Memon, M.U. (1983). «Abū'l-Barakāt Lāhūrī», s.v. [online]. In: *Encyclopaedia Iranica*, 1 (3), pp. 268-269. Available at <http://www.iranicaonline.org/articles/abul-barakat-monir-lahuri-indo-persian-poet-commonly-known-as-molla-monir-lahuri-b> (2015-12-01).



- Meneghini, Daniela (2004). «Kalim-i Kāshānī», s.v. [online]. In: *Encyclopaedia Iranica*, 15 (4), pp. 402-404. Available at <http://www.iranicaonline.org/articles/kālim-kasani> (2015-12-01).
- Muhsin Fānī (1964). *Masnavīyāt-i Fānī Kashmīrī*. Ed. by Sayyid Amīr Ḥasan Ābidī. Srinagar: Jammu and Kashmir Academy of Arts, Culture and Languages.
- Munīr Lāhorī, Abu'l-Barakāt (1977). *Kārnāma*. Ed. by Sayyid Muhammad Ikram. Islamabad: Markaz-i Tahqīqāt-i Fārsī-i Īrān va Pākistān.
- Munīr Lāhorī, Abu'l-Barakāt (2009). *Surūda-hā va navishta-hā-yi Munīr Lāhorī*. Ed. by Sayyid Farid Akram. Tih-rān: Mauqūfāt-i Bunyād-i Duktur Mahmūd Afshār, 1388.
- Pellò, Stefano (2015). «Persian Poets on the Streets: The Lore of Indo-Persian Poetic Circles in Late Mughal India». In: Orsini, Francesca; Butler Schofield, Katherine (eds.), *Tellings and Texts: Music, Literature and Performance in North India*. Cambridge: OpenBook Publishers, pp. 303-325.
- Pinder-Wilson, Ralph H. (1957). «Three Illustrated Manuscripts of the Mughal Period». *Ars Orientalis*, 2, pp. 413-422.
- Pinder-Wilson, Ralph H. (1989). «Picturing and Early Mughal Garden». *Asian Art*, 2 (4), pp. 58-79.
- Qasemi, Sharif Husain (1999). «Fānī Kashmīrī», s.v. [online]. In: *Encyclopaedia Iranica*, 9 (2), p. 207. Available at <http://www.iranicaonline.org/articles/fani> (2015-12-01).
- Rashidi, S.H. (1967-1969). *Tazkira-yi shu'arā-yi Kashmīr*. Karachi: Iqbal Academy.
- Saidī Tih-rānī (1985). *Dīvān-i Saidī*. Ed. by Muhammad Qahramān. Tih-rān: Ittilā'āt, 1364.
- Sharma, Sunil (2004). «The City of Beauties in the Indo-Persian Poetic Landscape». *Comparative Studies of South Asia, Africa and the Middle East*, 24 (2), pp. 73-81.
- Stronge, Susan (2002). *Painting for the Mughal Emperor: The Art of the Book, 1560-1660*. London: V&A.
- Tālib-i Āmulī (1967). *Kulliyat ash'ār-i Malk al-shu'arā-'i Tālib-i Āmulī*. Ed. by Muhammad Tāhirī Shahāb. Tih-rān: Ibn Sīnā, 1346.
- Thackston, Wheeler M. (1996). «Mughal Gardens in Persian Poetry». In: Wescoat, James L. Jr.; Wolschke-Bulmahn, Joachim (eds.), *Mughal Gardens: Sources, Places, Representations, and Prospects*. Washington, DC: Dumbarton Oaks, pp. 233-258.
- Thackston, Wheeler M. (ed. and trans.) (1999). *The Jahangirnama : Memoirs of Jahangir, Emperor of India*. Washington, D.C.; New York: Freer Gallery of Art, Arthur M. Sackler Gallery, Smithsonian Institution; Oxford University Press.

- Thackston, Wheeler M. (unpublished). *The Poetry of Abū-Tālib Kalīm, Persian Poet Laureate of Shāhjahān, Mughal Emperor of India* (Cambridge: Harvard University, 1974).
- Titley, Norah; Wood, Frances (1991). *Oriental Gardens*. London: British Library.
- Truschke, Audrey (2016). *Culture of Encounters: Sanskrit at the Mughal Court*. New York: Columbia University Press. South Asia Across the Disciplines Series.
- Willis, Garry (2003). «The Real Arcadia». In: Habegger, Larry; O'Reilly Sean; Alexander, Brian (eds.), *Travelers' Tales, Greece: True Stories*. San Francisco: Travelers' Tales.
- Zafar Khān Ahsan (1976). *Tahqīq dar ahvāl u āsār u afkār u ash'ār*. Ed. by Muhammad Aslam Khan. Dihlī: Indū Parshiyān Sūsā'itī, 1364.
- Zafar Khan Ahsan (1985). *Masnaviyāt-i Zafar Khān Ahsan*. Ed. by Muhammad Aslam Khan. Dihlī: Indū Parshiyān Sūsā'itī, 1364.
- Zutshi, Chitralekha (2014). *Kashmir's Contested Pasts: Narratives, Sacred Geographies, and the Historical Imagination*. New Delhi: Oxford University Press.

## Borders

Itineraries on the Edges of Iran

edited by Stefano Pellò

# A Linguistic Conversion

Mīrzā Muḥammad Ḥasan Qatīl  
and the Varieties of Persian (ca. 1790)

Stefano Pellò

(Università Ca' Foscari Venezia, Italia)

**Abstract** The paper deals with Mīrzā Muḥammad Ḥasan Qatīl, an important Persian-writing Khatri poet and intellectual active in Lucknow between the end of the 18th and the first two decades of the 19th century, focusing on his ideas regarding the linguistic geography of Persian. Qatīl dealt with the geographical varieties of Persian mainly in two texts, namely the *Shajarat al-amānī* and the *Nahr al-faṣāḥat*, but relevant observations are scattered in almost all of his works, including the doxographic *Haft tamāshā*. The analysis provided here, which is also the first systematic study on a particularly meaningful part of Qatīl's socio-linguistic thought and one of the very few explorations of Qatīl's work altogether, not only examines in detail his grammatical and rhetorical treatises, reading them on the vast background of Arabic-Persian philology, but discusses as well the interaction of Qatīl's early conversion to Shī'ite Islam with the author's linguistic ideas, in a philological-historical perspective.

**Summary** 1. Qatīl's writings and the Persian language question. –2. Defining Persian in and around the *Shajarat al-amānī*. –3. Layered hegemonies in the *Nahr al-faṣāḥat*. –4. Qatīl's conversion and the linguistic idea of Iran. –Primary sources. –Secondary sources.

**Keywords** Indo-Persian. Qatīl. Persian language. Lucknow. Shī'a. Conversion.

Nella storia del linguaggio i confini di spazio e di tempo, e altri,  
sono tutti pura fantasia

(Bartoli 1910, p. 900)

## 1 Qatīl's writings and the Persian language question

To convey the idea that someone is fluent in foreign languages – say, for instance, French – a speaker of Modern Greek may choose to say μιλάει Γαλλικά φαρσί (*milaei gallika farsi*). A strictly etymological rendering of the expression would be 'She/he speaks [the] French [language] Persian', where the word for 'Persian', *farsi*, is to be understood as an adverb, some-

thing like ‘the Persian-language way’ or, perhaps more closely, ‘Persianly’.<sup>1</sup> This curious lexical episode, where a glottonym such as φαρσί/Persian acquires the semantically specialized adverbial meaning of ‘fluently’, a direct heritage of the Ottoman era not surviving in modern standard Turkish, alludes to the pragmatic implications of the dominant multilingual practices – and corresponding linguistic poliphonies – in the pre-modern and early modern eastern half of the Islamicate world. Its persistence – paradoxically enough, given the strictly linguistic field of exercise – seems indeed to defy the late eighteenth and early nineteenth century projects of linguistic ‘purification’ by Hellenists, who often perceived the spoken varieties (and most written registers as well) of the Greek of their time as *mixovarvaros*, i.e. ‘mixed-barbarian’.<sup>2</sup> The adverb φαρσί, of course, does not provide any indications as to which form of ‘Persian’ would be the adverbial touchstone for measuring someone’s cosmopolitan ability to elegantly dominate a prestigious non-native idiom. At the western end of the Persianate polycentric space, Persian, to be linguistically crystallized as the *antonomasia* of ‘The (Foreign Refined) Language’ must of course be a sort of Saussurian abstraction of ‘Persian’, and the implied reference is thus not so much to any Iranian natural-historical language as to the perceived idea of the literary medium spread and employed, at various degrees, from Mostar to Linxia up to the 1800s, in fruitful dialogue with most of the various coexistent vernacular and non-vernacular traditions. A lexical fossil of linguistic transregionality, the Greek-Ottoman expression, which is reminiscent of the symbolic capital retained by the idea of Persian in Eurasia up to the colonial era, urges us as well – pretextually and contrastingly as it were – to pose many a question, mingling Pierre Bourdieu’s with Bert Fragner’s terminology, about the shifts in the dominant *doxa* and, consequently, in the reproduction of the linguistic *habitus* within the rapidly transforming Persophonie and its pedagogical and andragogical institutions. As a matter of fact, beyond any fetishization of the cosmopolis, a ‘Persian language question’, had been arising, between Iran and South Asia, precisely at the same time during which the spectre of the just evoked so-called ‘Greek language controversy’ was haunting Southeastern Europe and Asia Minor, in a broader interconnected context dominated by processes of nationalization, boundarization, identification,

1 Mpampiniotes’ monolingual dictionary explains the term with the adverb απτάιστως ‘fluently’; the dictionary adds that the word can also be used, more generally, to indicate that a student has learned a lesson ‘thoroughly’. As far as the etymology is concerned, Mpampiniotis concludes, quite unsatisfactorily: «from Turkish *farsi* «Persian» (περσικά), since the Turkish language contains many Persian words» (Mpampiniotes 1998, p. 1894).

2 I am thinking here of intellectuals such as Evgenios Voulgaris (1716-1806) and Adamantios Korais (1748-1833), on whom see for instance Rotolo 1965 and Mackridge 2009, pp. 80-101.

exclusion, reduction and re-canonization. Vindicating the essential role of philology and the persistent centrality of the forms of knowledge related to (poetical) language in the Islamicate curriculum, their marked long term tendency to connect to the textual past and their consistent ubiquity within the wider Persianate world,<sup>3</sup> I will introduce here some relevant material pertaining to linguistic history by a North Indian author, Mīrzā Muḥammad Hasan Qatīl, whose biographical figure and intellectual production, notwithstanding their obvious significance, has been thus far very little studied. In particular, I will present a selection of passages from Qatīl's works on Persian language – whose relevance was already recognized by Henry Blochmann (1868, p. 32) – looking for a first plausible socio-textual reading of his treatment of the regional, and local, varieties of Persian. With the aim of going beyond the flat and heuristically useless figure of the 'purist' and more or less 'Iranophile' Khatri of Nawabi decadence, and suggesting the linguistic-literary *pendants* of his conversion to Shi'ite Islam, I will reject any simplistic and anachronistic Iran vs. India polarization, which risks to dualize a much more pluralistic and nuanced continuity and polyphony, reducing to an essentialized monolingual monolith the multilingual world of Iran itself. Hopefully, this will also help to provide further material to articulate nuanced replies to Shamsur Rahman Faruqi's questions on the loss of Indian self-confidence in Persian proficiency (Faruqi 1998, pp. 1-2). In a more theoretical way, the excerpts introduced here might also stimulate further discussions on what Francesca Orsini has called «multilingual local», especially insofar as the complex productive relations (in a rapidly transforming literary and linguistic scene) between the non-static poles of 'learned traditions' and 'spoken language' are concerned.<sup>4</sup> While the texts we are dealing with have quickly become «homeless» (Tavakoli-Targhi 2001), an author and literary persona like Qatīl is at home in Lucknow as well as in Kabul, Isfahan and Tabriz, in an extended socio-semiotic dimension defying any comfortable 'Colonial', 'Nationalistic', 'Iranian' or 'Indo-Persian' label (Mana Kia's discussions of geocultural meanings and the location of 'Indo-Persian'<sup>5</sup> come to mind, as do Farzin Vejdani's recent observations on the inadequacy of a catch-all coloniser-colonised – itself

3 An exemplary case, particularly interesting here for its close connection, in the Persianate environment, with the analysis of phonological and morphological structures, is that of the cosmopolitan continuity of the study of the 'science of rhyme' (*'ilm-i qāfiya*): as far as the context of Awadh is concerned, an important commentary on Naṣīr al-Dīn-i Ṭūsī's authoritative thirteenth century treatise (the best study on Ṭūsī's work is Landau 2013) was completed in Lucknow by Sa'd Allāh-i Murādābādī as late as 1865, followed by several reprints and an Urdu translation (Pellò 2003, pp. 18-25).

4 I think, for instance, of Orsini 2012.

5 See for instance Kia 2014 and her unpublished conference paper.

quite colonising – discourse for contexts such as those analysed here<sup>6</sup>).

A quick bio-bibliographical sketch, based on an array of primary and secondary sources,<sup>7</sup> will help to introduce the main linguistic themes of this article. Mīrzā Muḥammad Ḥasan, generally known by his *takhalluṣ* (pen-name) of Qatīl, was born in Delhi in 1759 in a Khatri family. His father, Dargāhī Mal, moved from Panjab during the reign of Muḥammad Shāh (1719-1748), settling first in the village of Dasna and, subsequently, in Delhi, at the invitation of the nobleman Hidāyat ‘Alī Khān Bahādur. Educated for a prominent *munshī* career (his ancestor Siyālkotī Mal Vārasta was a notable lexicographer and literary critic<sup>8</sup>), the young Hindu student became early in his life the disciple of a Shi’ite poet of Iranian origin, Muḥammad Bāqir Shahīd Iṣfahānī, under whose influence, according to Muṣḥafī, he converted to Shi’ite Islam at the age of eighteen (Muṣḥafī 1934, p. 46; according to other sources, the conversion happened before, when he was 14 or 17). He worked for a while in the army of Najaf Khān Zū ‘l-Fiḡār al-Dawla in the Delhi area, and in 1783-84 he finally moved to Lucknow, where he became an established poet, philologist and teacher of Persian. According to the *tazkira Sham’-i anjuman*, he also spent some time in Kalpi with ‘Imād al-Mulk Fīrūzjang III (Navāb 1875, p. 390), and several sources also mention his travels to Iran and Iraq. He died during the reign of Ghāzī al-Dīn Ḥaydar (various dates are indicated, including 1817, 1822 and 1825), and was buried in the Qaysar Bagh of Lucknow, which was, at that time, a *ḥusayniya* (i.e. a assembly hall, known in South Asia as *imāmbara*, devoted to Shi’ite commemoration ceremonies). A polyglot (in addition to Persian and Hindi/Urdu he mastered Arabic and Turkish as well) and prolific writer, Qatīl wrote all of his important works in Persian, and acquired during his life a short-lived status as one of the leading ‘masters’ of Persian poetry in Lucknow.<sup>9</sup> However, more than for his poetic works (neither his *dīvān* nor his historical *maṣnavī* entitled *Ṣubḥ-i bahār*

6 An articulate discussion on the subject, specifically relating to the Qajar period, can be found in the introduction to Vejdani 2015.

7 Besides Qatīl’s works, these include: Abū Ṭālib ibn Muḥammad Iṣfahānī (MS, f. 360r), Āftāb Rāy (1982, pp. 119-121), Alam, Subrahmanyam (2012, pp. 423-426), Anūsha (2001, 3, pp. 2032-2034), Anvarī Farīdābādī (1939), Hadi (1995, p. 490), Hindī (1958, pp. 172-173), Marshall (1967, pp. 397-398), Mīrānjān Ajmalī (MS, ff. 123r-v), Munzavī (1983-1997, 1, p. 841; 2, p. 1015; 3, p. 2534), Muṣḥafī (1934, p. 46), Najm-i Ṭabāṭabā’ī (MS, ff. 149v-150r), Navāb (1875, pp. 390-392), Pellò (2012, pp. 161-168), Sprenger (1854, 1, pp. 170, 535).

8 See the notes by Sīrūs Shamīsā in the introduction to the dictionary *Muṣṭalahāt al-shu‘arā* (Siyālkotī Mal Vārasta 2001, pp. 25-36).

9 Some notes on Qatīl’s school can be found in Pellò 2012, pp. 146-9. The dismissive tones attributed by Āzād to Ghālib when talking about Qatīl, who was «only a Khatri from Farīdābād», are well known (see Āzād 1982, p. 505).

have been published<sup>10</sup>), Qatīl is remembered for his scholarly works in prose.<sup>11</sup> Beyond the didactical *Mazhar al-'ajā'ib*, a ponderous repertoire of poetic tropes organized in a thematic fashion,<sup>12</sup> and the doxographical *Haft tamāshā*, an invaluable work on South Asian ethno-religious groups, what primarily concerns us here are the three treatises variously devoted to linguistic subjects and especially Persian (and, in one case, also Turkish) language, grammar, rhetoric and letter writing. The oldest of these, the *Shajarat al-amānī*, was completed in 1206/1791 and dedicated to Qatīl's friend and collaborator Sayyid Amān 'Alī. In the preface, the author writes that the «*Shajarat al-amānī* consists of some lines describing some things which must necessarily be known as far as Persian poetry and prose are concerned» (*saṭr-i chand-ast dar bayān-i ba'zī chīzhā ki dar naẓm u naṣr-i fārsī az dānistān-i ān gurīz nabāshad*) (Qatīl 1872, p. 2). The work is subdivided into six sections called *far'* (pl. *furū'*, i.e. 'branches'), each of which leads to some *ṣamara* or 'fruits'. Namely, the first *far'* is devoted to the «essence of word and its subdivisions» (*māhiyat-i kalima va taqṣīm-i ān*) (Qatīl 1872, p. 2), with four *ṣamara*: 1) the nature of 'word' (*kalima*), the distinction between *kalima* and *lafẓ* 'expression', and the (traditional) tripartite subdivision of *kalima* in name (*ism*), verb (*fi'l*) and particle (*ḥarf*); 2) the name (*ism*); 3) the verb (*fi'l*); 4) the particle (*ḥarf*) (Qatīl 1872, pp. 3-4). The second *far'*, devoted to the indispensability of the 'word' (*kalima*) and its possible elisions in normal speech, bears only one fruit, where the author, following the traditional *ḥarf*-based 'morphematic' grammatical analysis already found *in nuce* in Shams-i Qays (as observed by Zumurrudiyān 2000), critically describes at length the peculiarities of the *kāf* (e.g. the declarative conjunction *ki*, the diminutive suffix *-ak*, etc.), of the *yā* (e.g. the ending *-ī* of relative adjectives, the verbal desinence of the second person singular *-ī*, etc.) and so on (Qatīl 1872, pp. 4-13). The third *far'*, on composition (*tarkīb*), has two fruits, collectively describing the *izāfa* connection, the different typologies of compounds, nominal and verbal phrases etc. (Qatīl 1872, pp. 14-15). The fourth *far'*, which will be at the centre of our discussion here, is devoted to the «description of Persian language» (*dar bayān-i zabān-i fārsī*), in three *ṣamara*: the «language of the Turanians» (*dar zabān-i tūrāniyān*), i.e. Central Asian Persian, the «Persian of the Iranians» (*dar fārsī-yi irāniyān*), and the «Persian of the

10 The copy of Qatīl's *dīvān* which I have consulted at the Rampur Raza Library contains a total of ca. 2200 *bayts*, mostly of *ghazals*, but including *tarkīb-bands*, *tarjī'-bands*, *mukhammas*, *marthiyas* and *rubā'īs* as well (Qatīl Ms). A copy of Qatīl's *maṣnavī* is kept at the Punjab University Library of Lahore (n. 7683-o-456).

11 A list, with short descriptions, of Qatīl's works can be found in Anusha (2001, 2, pp. 2033-4).

12 The printed copy, published in 1291/1874 by Naval Kishor, consists of 254 lithographed pages (Qatīl 1874b).



people of India» (Qatīl 1872, pp. 15-20). The fifth *far'*, in two *ṣamara*, focuses on *faṣāḥat* 'clarity of expression' at the level both of single words and of sentences (Qatīl 1872, pp. 20-22), while the sixth and final chapter, in a single *ṣamara*, briefly explores the closely-related rhetorical territories of *balāghat* 'eloquence' or better perhaps, *elocutio* (Qatīl 1872, pp. 22-23).

Most of these subjects will receive further attention in the slightly later *Nahr al-faṣāḥat* (1214/1799). As Qatīl himself states, the work was composed at the request of Mīr Muḥammad Ḥusayn, the nephew of the above-mentioned dedicatee Mīr Amān 'Alī. The *Nahr al-faṣāḥat* is a relatively lengthy work (the 1874 printed edition is 69 pages, as opposed to the 24 of the *Shajarat al-amānī*) subdivided into ten 'waves' (*mawj*), complementing the preceding work with a more practical and applicative attitude and plenty of examples, both in poetry and prose, respectively focusing on: 1) «the teaching of some things whose abandonment is mandatory and recommended» (*ta'līm-i ba'zī chīzhā ki tark-i ān vājib u mustahsin-ast*), devoted to the elimination of some non-standard written and oral linguistic practices (Qatīl 1874a, pp. 3-12); 2) the use of some particular verbs (Qatīl 1874a, pp. 12-15); 3) «the explanation of what is necessary and what is recommended» (*dar bayān-i vājibāt u mustahsināt*), i.e. on some morphosyntactical rules and conventions of the Persian language (Qatīl 1874a, pp. 15-23); 4) «the mandatory additions» (*zavā'id-i vājibī*), for instance the use, in prose, of some numerators such as *sar* 'head' to count horses or *zanjīr* 'chain' to count elephants (Qatīl 1874a, p. 23); 5) «the description of the compounds» (*dar bayān-i murakkabāt*) (Qatīl 1874a, pp. 23-25); 6) «the description of prescriptions and elisions» (*dar bayān-i muqaddarāt u maḥzūfāt*) (Qatīl 1874a, pp. 25-36); 7) the theory and practice of figurative speech (*'ilm-i bayān*) (Qatīl 1874a, pp. 36-41); 8) the Persian language, again, as we shall see, subdivided into the three varieties of Iran, Turan and India (Qatīl 1874a, pp. 41-42); 9) «the differences between the poetry of the ancients and the moderns, and the prose of the Indians and the native speakers» (*dar bayān-i farq-i ash'ār-i mutaqqaddimīn va muta'akhhirīn va naṣr-i hindiyān va ahl-i zabān*), directly connected to the preceding 'wave' (Qatīl 1874a, pp. 42-43); 10) «the teaching of how to write prose» (*dar ta'līm-i taḥrīr-i naṣr*): the latter section, which covers more than one third of the entire book, includes a rich set of ready-to-use expressions and linguistic-literary protocols for the *munshī* as well as some precious specimens of letters written in different styles and for potential everyday situations (Qatīl 1874a, pp. 42-69).

A highly refined and multilingual approach marks the third, and last, linguistic work of Qatīl mainly dedicated to Persian, the *Chār sharbat* (completed in 1217/1802). The book, where the author boasts of his knowledge of the Turkish language from the very first pages (Qatīl 1845, pp. 2-3), consists of four sections, as the title itself suggests, called *sharbat* 'beverages', with some sub-chapters called *chānāgh*, a learned Turkic word meaning 'crater'. The first *sharbat* is devoted to metrics and rhyme (*'arūz*

va *qāfiya*); the second deals with the «expressions of the native speakers» (*muṣṭalahāt-i ahl-i zabān*); the third section discusses the techniques and different styles (such as those of literati, sufis and secretaries) of letter-writing, again with several textual examples; the fourth and last section is, finally, a grammar of late Eastern Tūrki<sup>13</sup> with different chapters for substantive, verbs, etc.<sup>14</sup>

## 2 Defining Persian in and around the *Shajarat al-amānī*

Observations regarding the differences between the regional varieties of Persian and, more generally, ‘correct’ and ‘incorrect’ linguistic usages, are scattered throughout Qatīl’s works, including the doxographic *Haft tamāshā* as well as the author’s letters (*Ruq’āt*), as we shall see. However, the main sources for Qatīl’s geographical taxonomy of the world of Persian are, not surprisingly, his first two, and most strictly linguistic, treatises, where, as I have briefly noted above, the author deals with the subject in dedicated chapters. In the older of the two, the *Shajarat al-amānī*, Qatīl introduces his treatment of the subject in the fourth chapter (*far’*), «on the Persian language» (*dar zabān-i fārsī*).<sup>15</sup> The first of the three sections into which the chapter is divided, Qatīl informs the reader, is devoted to the «language of the Turanians (*zabān-i tūrāniyān*)». Before taking on the task of describing it, Qatīl makes some interesting general remarks regarding the ‘correct use’ of the Persian language, at the same time making clear the main didactic aim of his work:

Since the pillar of writing poetry and prose in Persian is the correctness of the language (*ṣiḥḥat-i zabān*) and the accuracy in following the native speakers (*durustī-yi tatabbu’-i ahl-i zabān*), the secretary and the poet must be aware of Persian peculiar vocabulary and conversation, and the student of this discipline should not interfere with the current language (*rūzmarra*) of the native speakers (*ṣāḥibzabānān*) and make use of what

13 This is made clear, among other things, from the presence of the post-terminal perfective in Up- and the optative in GAy. I am grateful to my friend and colleague Matthias Kapler for his invaluable turcological advice.

14 This polyglot approach of Qatīl is apparent not only in his collaboration with Inshā Allāh Khān in the composition of the famous *Daryā-yi laṭāfat* (as the author of the section on prosody and rhetoric), the first grammar (written in Persian) of the Urdu language (1802), but also in a little known grammar of the Arabic language, also in Persian, entitled *Qānūn-i mujaddad*, a copy of which is currently held at the British Library (see Rieu 1881, p. 795), about which Qatīl himself talks repeatedly in his letters (Qatīl 1887, pp. 8, 30, 68).

15 Some interesting notes on the treatment of the varieties of Persian in this text and in the *Nahr al-faṣāḥat* can be found in Quraishi 1969.

he finds in their books, considering himself an imitator, since there is a great difference between what is original (*aṣl*) and what is reported (*naql*). The imitator (*muqallid*) is held in consideration by the knower of the language (*zabāndān*) only through his hard work in poetry and prose. (Qatīl 1872, p. 16)

The non-native professional user of the Persian language, as Qatīl himself is, must adhere strictly to a standard which is loosely identified here with the usage of native speakers (*ahl-i zabān*). A simple, dicotomic hierarchy, a reminder of the more complex one described by Faruqi (1998, pp. 1-2), is immediately provided: on the one hand the non-native (Indian) learner, read as a *muqallid* (imitator), and, on the other hand, the knower of the language (*zabāndān*). The latter is modeled on the image of the native speaker of the *ahl-i zabān* but, subtly enough, not completely limited to it (devoting space to transitional socio-linguistic figures such as that of Qatīl himself). A parallel polarized dicotomy is quickly drawn between a 'book Persian', which is the main source of the imitator, and the current language (*rūzmarra*), which is off-limits for the beginner or the amateur but not for the 'near-native' teacher personified by the writer himself.<sup>16</sup> A proper application of *taqlīd* – i.e. imitation and adherence to the standards of vocabulary and conversation – will ensure the discent the most desired prize, the prestige coming from the recognition by the linguistic authority personified by the *zabāndān*.<sup>17</sup> Linguistic creativity by the *muqallid* is, then, at the very least problematic:

This discourse is supported by what they say about Mīrzā Bīdil – mercy be upon him – who invented the idiom *khīrām kāshān* (lit. 'to seed a graceful walking') in the elegy for his son, and also *imṣubḥ* (this morning) and *imshām* (tonight): the reason for the mistake found in these idioms is the fact that the above-mentioned Mīrzā [Bīdil] was Indian. As a matter of fact, if he had been from the land of Isfahan or another city in the country of Iran, the abstruse uses (*shuturgurbahā*) of which he

16 It is fascinating to observe how some fifty years later, in the context of Napoleon III France, the Polish scholar Aleksander Borejko Chodźko would write, in the preface to his *Grammaire de la langue persane*, that: «La langue usuelle est bien le persan, le seul persan vrai: la langue de la cour, des lettres et de la nation. Je ne connais pas même de langue qui ait un caractère de nationalité aussi fortement déterminé, et qui soit en même temps aussi soigneusement cultivée» (Chodźko 1852, p. II). Chodźko – who served as translator at the Russian missions in Tabriz and Tehran and as consul at Rasht during the 1830s – writes these lines while lamenting the absence of European instruments for learning the «langue usuelle» as opposed to the artificial «persan littéraire»: the contrast is closely reminiscent of Qatīl's observations, projected onto the screen of nineteenth century nationalistic discourse.

17 It should not go unnoticed that both *taqlīd* and *muqallid* are also technically characterised terms in Shi'ite *fiqh*, building a methodological and hermeneutical bridge between the linguistic and the juridical domains, as we shall articulate later on in this paper.

is accused in his poetry, so excellent in meaning and new endeavours, would not have been sanctioned and no one would have said a word in dismissing him [...]. The truth is that whatever interventions (*taṣarruf*) the native speakers operate in their own language (*zabān-i khwud*), the imitators are not allowed to say that much about them. (Qatīl 1872, p. 16)

The choice of Bīdil, the most influential master of the poetical 'new diction' of *tāzagūyī* in late seventeenth and early eighteenth century Delhi, as the object of Qatīl's linguistic censorship comes as no surprise, considering Qatīl's declared adherence to the critical dictate of 'Alī Ḥazīn and his followers.<sup>18</sup> More specifically, the very insistence, here and elsewhere, on the key-concept of *muḥāvara* 'idiom', but also 'spoken language' and 'conversation', echoes the central themes of the chapter on the 'science of conversation' (*'ilm-i muḥāvara*) included by 'Alī Ḥazīn in a little-known treatise on dialectics entitled *Muzākārāt fī 'l-muḥāzarāt*.<sup>19</sup> In the *Shajarat al-amānī*, however, Qatīl's objection is related not so much to the inventions and changes themselves as to the power to introduce them in the language: Qatīl makes it very clear that the right to modify the language belongs exclusively to those who 'possess' the language itself. In the lines that follow, he will elaborate:

Generally speaking, Persian is of two types (*naw'*), the Persian of Iran (*fārsī-yi Īrān*) and the Persian of Turan (*fārsī-yi Tūrān*). There are some expressions which are specific to the people of Turan, which are not understood by the people of Iran, and some others which are proper to the Iranians, and are unknown to the Turanians; similarly, in Iran as well as in Turan, there are some expressions which are specific to the people of each city. (Qatīl 1872, p. 16)

The traditional, persistent and problematic subdivision of 'Persian' in the various 'types' (*naw'*) of *pārsī*, *pahlavī*, *darī*,<sup>20</sup> etc., which can be traced

**18** Ḥazīn is mentioned by Qatīl as an authority in several places (in the *Chahār sharbat*, for instance, he is called *khāṭam al-shu'arā al-muta'akhhirīn* 'the seal of the modern poets', evoking Jāmī's towering figure (Qatīl 1845, p. 44), and, significantly, he is one of the main sources for the above-mentioned *Mazhar al-'ajā'ib* (see both the introduction and the *khāṭimat al-ṭab'*, where Qatīl's poetical library is described in detail, with Ḥazīn in second position after Niẓāmī) (Qatīl 1874b, pp. 2, 253). On the pro-Ḥazīn positions of Qatīl's ancestor, the lexicographer Siyālkoti Mal Vārasta, in the mid-eighteenth century Indo-Persian critical debate, see Shamīsā in Vārasta 2001, pp. 25-31.

**19** According to the definition given by Ḥazīn himself, «*Muḥāvara* consists of the knowledge of the modes of a fluent exposition and the contingencies of speech, the embellishing of narration with stories about people, familiarity with examples, wit, elegant lines and refined anecdotes» (Ḥazīn 1998, p. 56).

**20** It is worth underlining once again, in order to avoid any possible misunderstanding, that the application of the term *darī* to identify Persian as used in Afghanistan is relatively

back to the Omayyad writer Ibn al-Muqaffa' (Lazard 1971; Khānlarī 2003-4, pp. 271-281) and will still be popular among some influential intellectuals at the end of the nineteenth century,<sup>21</sup> is abandoned here, and no trace of it can be found in Qatīl's writings. By recalling Āzar Baygdīlī's tripartite cultural geography – Hindustan will come immediately afterwards – of the Persianate world (Kia 2014), Qatīl provides a systematization which might recall the contemporary distinctions between 'Western', 'Eastern' and 'colonial' Persian in linguistic studies (cf. Windfuhr, Perry 2009, pp. 417-41).<sup>22</sup> Qatīl's 'geocultural' subdivision, however, is constructed mainly on lexical contrasts, and, as we shall see, the boundaries he traces are definitely not phonological. Before going into the details of the geographical varieties, the author adds:

When speaking and writing normal correspondence, one must choose the current usage (*rūzmarra*) of the people of Iran; when composing poetry and *inshā* in solid ornate style, one should not tie oneself to a single current usage. As a matter of fact, by doing so, one would contradict the way of the masters, and a forced attempt to look Iranian (*tamaghghul*)<sup>23</sup>

recent (the name of the language was officially changed to *darī* with the new Constitution of 1964) and is not directly related to the subjects we are dealing with here. Any straightforward identification of *darī* with «Afghan Persian» (pace Pritchett 2003, p. 884) before the 1960s is, indeed, anachronistic and erroneous, as extensively discussed in Spooner 2010, pp. 89-101 and elsewhere.

21 This kind of taxonomy, which, for instance, had been employed, variously re-elaborated, in the introductions to the three great Indian dictionaries of the seventeenth century (*Farhang-i Jahāngīrī*, *Burhān-i qāṭī'* and *Farhang-i Rashīdī*) (Injū Shīrāzī 1980, 1, pp. 13-22; Husayn Tabrizī 1964, 1, ṭ-yā; 'Abd al-Rashīd 1958, 1, p. 45), in a widespread Mughal grammar of Persian (Hānsavī 1884, pp. 4-5) and in Ārzū's refined eighteenth century philological *Muṣmir* (Ārzū 1991, pp. 4-13), will be re-proposed in European grammatical writings on Persian (for instance, Jones 1807, pp. 416-429; Lumsden 1810, p. 1) and up to the time of what is considered to be one of the first 'modern' grammars of Persian written by an Iranian, the *Dabistān-i pārsī* by Ḥabīb Iṣfahānī (1892, pp. 4-5; 2003, p. 40).

22 Different degrees in the acknowledgement of geographical variation are of course well-documented throughout Persian textual history. Apart from the well-known eleventh-century observations by the Khorasanian Nāṣir-i Khusraw regarding the lack of knowledge of Persian (*zabān-i fārsī*) by the renowned Tabrizi poet Qaṭrān, most probably a speaker of Persian (the Iranian language of historical Azerbaijan, not to be confused with later Azeri Turkish) not always comfortable with the 'Eastern' lexicon used by the masters of the Samanid times such as «Munjīk and Daqīqī» (Nāṣir-i Khusraw 1972, p. 8), it is worth mentioning here the method described by Injū Shīrāzī in the introduction of his *Farhang-i Jahāngīrī* (where he boasts of having travelled extensively to register the regional uses) (Injū 1980, 1, pp. 9-10) and, most notably, the distinction between Iranian, Turanian and Hindustani usage already referred to, although not as systematically as in Qatīl, by Ārzū and Mukhlīṣ in the eighteenth century (for instance Mukhlīṣ 2013, p. 36 of the English introduction).

23 The term is derived from the ethnonym *mughul* and modeled on the paradigm of an Arabic verbal noun. It is Qatīl himself to give a definition of *mughul* as used in India: «The descendants of people from the lands of Iran and Turan, from wherever they are, are called in

keeps poetry far from refinedness: a written Persian which follows the use of the masters of the past is good. (Qatīl 1872, p. 16)

After having warned the «imitators» of the special care that must be taken – i.e. the necessity of being able to adapt to the socio-textual context – when dealing with the choice between the «current usage» of Iran vs. the «use of the masters of the past», Qatīl provides nearly forty examples of divergent usages between the Turanian and Iranian Persian. These are composed mostly of nouns and adjectives, but also of verbs, pronouns and idiomatic expressions, juxtaposed in contrast to their perceived standard literary and/or Iranian counterpart. The list (roughly reorganized from Qatīl 1872, pp. 16-17) includes:

#### 1. Nouns

Turanian	Iranian	
<i>khusur</i>	<i>pīdarzan</i>	(father-in-law)
<i>ṭughāyī</i>	<i>barādar-i mādar</i>	(maternal uncle)
<i>khwushdāman</i>	<i>mādarzan</i>	(mother-in-law)
<i>khusurpūra</i>	<i>barādar-i zan</i>	(brother-in-law)
<i>yazna</i>	<i>shawhar</i>	(husband)
<i>nīka</i>	<i>zan-i barādar</i>	(sister-in-law)
<i>dādar</i>	<i>barādar</i>	(brother)
<i>shū</i>	<i>shawhar</i>	(husband)
<i>piḡāh</i>	<i>ṣubḡ</i>	(daybreak)
<i>bīḡāh</i>	<i>shām</i>	(evening)
<i>dīna rūz</i>	<i>dīrūz</i>	(yesterday)
<i>‘āfiyat</i>	<i>zīkr</i>	(spiritual exercises)
<i>sū</i>	<i>ṭaraf</i>	(direction)
<i>khubcha</i>	<i>chūbdastī</i>	(walking stick)
<i>sarsurkhak-i bāzārī</i>	<i>sham‘</i>	(candle)
<i>garmak</i>	<i>shalgham</i>	(turnip)
<i>lablabu</i>	<i>chughundur</i>	(beet)
<i>pūz</i>	<i>sīr</i>	(garlic)
<i>qaltabān</i>	<i>qurramsāq</i>	(pimp)
<i>(zan-i) mānda</i>	<i>zan-i ṭalāqdāda</i>	(repudiated woman)

India *mughul* and *mughulbachcha*» (Qatīl 1875, p. 113). Given the context and the reference to the *rūzmarra*, I suggest in my translation that Qatīl is here referring in particular to Iran.

2. Verbs and verbal nouns

<b>Turanian</b>	<b>Iranian</b>	
<i>pālīdan/kāftan</i>	<i>justan</i>	(to search)
<i>bar tāftan-i tīr</i>	<i>andākhtan-i tīr</i>	(to throw an arrow> to fire)
<i>raftagī</i>	<i>rafta and raftanī</i>	(gone; that must go)
<i>shīstan</i>	<i>nīshastan</i>	(to sit)
<i>khāstan</i>	<i>bar khāstan</i>	(to get up)
<i>savār shudan-i āb</i>	<i>ziyād shudan-i āb</i>	(to overflow (water))
<i>savār shudan-i rūz</i>	<i>guzashtan-i ruz</i>	(to wear away (day))
<i>pāyīdan</i>	<i>qarār numūdan</i>	(to establish)
<i>khusbīdan</i>	<i>khwābīdan</i>	(to sleep)
<i>māndan</i>	<i>nihādan</i>	(to put; to place)
<i>māndan/nihādan</i>	<i>guzāshtan</i>	(to put; to place)
<i>khalānīdan</i>	<i>gāyīdan</i>	(to fuck)
<i>pāyīn shudan</i>	<i>furūd āmadan</i>	(to descend)
<i>qurbān-at ravam</i>	<i>qurbān-at shavam</i>	(may I be sacrificed for you)

3. Pronouns

<b>Turanian</b>	<b>Iranian</b>	
<i>vay</i>	<i>ū</i>	(he/she)

4. Interjections

<b>Turanian</b>	<b>Iranian</b>	
<i>ārī</i>	<i>balī</i>	(yes)

After having drawn a first principal geographical-linguistic boundary, Qatīl proceeds to describe some local features within the Turanian variety, again basing them on lexical peculiarities:

*‘āfiyat, sarsurkhak-i bāzārī, khūbcha, garmak, lablabū* are specific to the Kabulis, and the others use these words in imitation of them, while the expressions *dādar, khalānīdan* and *kāftan* are typical of the people of Balkh; all the others are shared. (Qatīl 1872, p. 17)

The Kabuli sub-variety, which is, together with the speech of «the people of Balkh» the only dialect of Turanian Persian mentioned by Qatīl, when applying his theory as delineated above seems to be the most prestigious one, capable as it is of influencing the speech of the «imitators» (in this case the other Turanians). The description of Iranian Persian – actually a list of ‘terms and expressions’ (*alfāẓ va ‘ibārāt*) deemed peculiar to the «people of Iran» – will immediately follow. Single lexical terms from a ba-



sic everyday spoken vocabulary, often explained by Qatīl with perceived ‘standard’/literary words, include:<sup>24</sup>

*khālū/dāyī* = *barādar-i mādar* ‘maternal uncle’  
*darkhāna* = *darbār* ‘court’  
*chīz* = *ṭa’ām* ‘meal’  
*chāshṭ kardan* = *ṭa’ām-i rūz [khwurdan]* ‘to eat lunch’  
*chi vaqt* = *kudām vaqt* ‘when? (lit. what/which time?)’  
*shām kardan* ‘to have dinner’  
*chīz khwurdan* ‘to eat something’

The persistent lexical presence of Turkic loanwords in the Iranian usage can be seen in the following examples provided by Qatīl:

*utāq* = *khayma* ‘tent’  
*ūchāq* = *dīgdān* ‘tripod’  
*īshik āqāsī* = *dārūgha-yi divānkhāna* ‘chief usher’  
*qushūn* = *sipāh* ‘army’  
*kashakkhāna* = *chawkīkhāna* ‘guard house’

Notably enough, the first two examples – of which the first, *utāq*, has become contemporary standard Persian for ‘room’ – would not be recorded in the Indian-based late nineteenth century well-known Persian-English dictionary by Steingass. Also, as far as the relationship with the Indo-Persian milieu is concerned, the last example, *kashakkhāna* explained with *chawkīkhāna*, shows a deliberate attempt at explaining the Turkic-Persian compound used in Iran (T *kashak* ‘guard’ + P *khāna* ‘house’) with the corresponding term used in India (not in literary usage nor in Central Asia), where the first half of the compound is substituted by Hindi *chawkī* ‘guard’. A significant amount of the vocabulary archived as «Iranian» by Qatīl in the *Shajarat al-amānī* comes from an abusive and obscene register (cf. also the *qaltabān/qurramsāq* ‘pimp’ seen above), for instance:

*harzachāna* = *shakḥ-i bihūda* ‘babblers’  
*pīzishul* = *kūngushāda* ‘sluggard’ (lit. ‘wide ass’)  
*zanjalab* ‘sb. whose wife is a bitch’  
*zanqaḥba* ‘sb. whose wife is a prostitute’  
*kusdīhmādar* ‘sb. whose mother gives her pussy away’  
*kīrkhurdakhwāhar* ‘sb. whose sister has eaten a cock’  
*sinda* ‘turd’  
*mardika* ‘maggot (pej.)’

24 The Iranian expression is on the left, followed by the explanatory synonym, when provided by the author. All the examples in the following paragraphs are from Qatīl 1872, pp. 17-19.

Qatīl's insistence on representing obscene and abusive vocabulary throughout his linguistic writings shows a clear adherence to widely-experimented lexicographic protocols (see Zipoli 1996) coupled with an evident attention to the vernacular and sub-standard usages, calling to mind interconnected approaches to obscenities and the linguistic institutionalization of later Qajar times.<sup>25</sup> For instance, as far as the term *pīzīshul* is concerned, it is interesting to observe in this regard that the Qajar poet, lexicographer and *tazkira*-writer Rizā Qulī Khān Hidāyat (1800-1871) would describe *pīzī*<sup>26</sup> as a synonym of *kūn* 'ass' «in the use of the common people», quoting as well a recent poetic employment of the term in an obscene line by Qā'im-i Maqām Farāhānī (Hidāyat 1871, p. 243). A similar attitude is adopted by Qatīl while illustrating common Iranian sayings and idiomatic sentences, where obscene and abusive language occurs alongside normal ready-to-use expressions of the spoken language. Among the several examples we find: greetings and ceremonies (*ta'āruf*) such as *shab ba khayr* and *shab ba sa'ādat* 'good evening/night', *bifarmāyīd* 'please', 'please take a seat', *khwushāmadīd* 'welcome', *khwushyāftam* 'my pleasure', '*arż kunam khidmat-i mulāzimān-i shumā* 'I present to the service of your attendants'; non-standard expression such as *tūy-i hujra nishasta* 'sitting in the room' (to exemplify the use of *tūy* instead of *dar* 'in'); idiomatic uses as in *dar dam-i darvāza nishasta būdam* 'I was sitting in front of the door' and *farzand-i kujā-ī* 'where are you from?' (lit. 'you are the son of where?'), in contrast to the more elevated *mardum-i kujā-ī* (lit. 'you are the people of where?');<sup>27</sup> teasing expressions such as *shuma īn chak u chāna kujā ba ham rasānīd* 'where did you get this pomposity?'; curses and abuses such as *chashm-ash kūr shavad* 'may he become blind', *īn ham 'ajab kharkus-ī-st* 'this is also a real moron' (lit. 'donkey-pussy'), *ba kus-i zan-ash mīkhandad* 'he laughs at his wife's pussy', etc. After completing his relatively long exploration of the Iranian spoken dimension, Qatīl gets back to the Iranian-Turanian contrast:

Summing up, the expression which we provided as correlative of those used by the Turanians are commonly used among the people of Iran. The latter pronounce (*ba ṭalaffuḏ bar ārand*) *ghayn* instead of *qāf*, and vice-versa: *ghuncha* > *quncha* 'rose-bud'), *gharīb al-vaṭan* > *qarīb al-*

25 Notably enough, the most important Iranian scholar of Persian grammar of the nineteenth century, the already mentioned Mirzā Ḥabīb Ḥsafhānī, was also a prominent and prolific author of *hazliyat*, among which two *maṣnavīs* stand out for their philologically refined lexical research, namely the *Chahārgāh-i kus* (The Four Seasons of the Pussy) and the *Kīrnāma* (The Book of the Cock) (see, respectively, Zipoli 1999 and Ḥabīb Ḥsafhānī 2004).

26 Significantly, as in the Turkic cases of *utāq* and *ūchāq* seen above, neither *pīzī* nor the compound *pīzīshul* are recorded in the well-known *Comprehensive Persian-English Dictionary* by Francis J. Steingass (1892).

27 Cf. present day standard Persian *ahl-i kujā-ī* and colloquial *baccha kujā-ī*.

*vaṭan* ‘away from home’, ‘displaced’, *qurramsāq* > *ghurramsāgh* ‘pimp’, *zanqaḥba* > *zanghaḥba* ‘sb. whose wife is a prostitute’. Instead of *alif* they very often use *vāv*: *jān* ‘soul’ becomes *jūn* and *nān* ‘bread’ becomes *nūn*. The well-educated and common people talk the same way (*ba hamīn nasq guftugū kunand*), and even if some of them, by way of affectation, avoid such uses, the general situation is like this. (Qatīl 1872, p. 18)

Some innovative phonetical traits of Western Persian are mentioned: the converging pronunciation of both the voiced velar fricative *ghayn* and the voiceless uvular stop *qāf* as a voiced uvular stop [ɢ] or, in unstressed intervocalic position, a voiced velar fricative [ɣ], and the the passage of /ɑ:/ to /u:/ in some specific cases. In another passage, at the beginning of the *Shajarat al-amānī*, Qatīl had mentioned in passing the alternative use, in Turan and Iran, of *majhūl* (/e:/ /o:/) and *ma'rūf* (/i:/ /u:/) phonemes in some specific cases (Qatīl 1872, p. 4). However, more than the scattered phonological observations in themselves, it is the socio-linguistic attention shown by Qatīl that stands out here: as far as the authority in spoken and sub-standard Iranian Persian is concerned, he observes, no difference is to be found among social classes. He will soon get back to such diastratic issues, while other geographic aspects are dealt with in the paragraph immediately following:

Once you have learned this, learn as well that the Isfahanis use the term *tūy* instead of *dar* ‘in’ [...], *marg* (lit. ‘death’) instead of *qasam* ‘oath’ [...] *bifarmāyīd* instead of *binishīnīd* ‘please take a seat’, which, we have seen, is typical of them and the others have learnt from them. *Kharkus* (lit. ‘donkey-pussy’), *gāvkūn* (lit. ‘cow-ass’) instead of *aḥmaq* ‘stupid’, *man-rā* instead of *ma-rā* ‘me’, *shaw* instead of *shab* ‘night’ are all expressions of the Khorasanis. The Isfahanis change every *alif* in *vāv*, whereas the Isfahanis only change in *vāv* the *alif* which precedes a nasalized *nūn* (*nūn-i ghana*). The latter, because of the speed of their letters, elide the original letters: so *rīkhta* ‘poured’ becomes *rīta* and *sūkhta* ‘burned’ becomes *sūta*; *bāshī* instead of *qurramsāq* ‘pimp’ is also an expression of theirs. (Qatīl 1872, pp. 18-19)

Just as the prestigious dialect of Kabul influences the other Turanian sub-varieties, the local Isfahani Persian is ‘learnt’ by the other Iranian speakers, being for Qatīl, as we shall see, the ‘best’ among all the varieties of Persian. In such a geo-linguistic context, North India comes immediately afterwards:

Third *ṣamara*, on the description of the Persian of the people of India, and specifically of those who are not imitators of and intimate with the people of Iran. It is of two kinds: the first is the language of the books,

which, notwithstanding the fact that it is different from the current use (*ruzmarrā*) of both languages (i.e. Turanian and Iranian Persian), is correct. (Qatīl 1872, p. 19)

These observations are followed by an exemplary specimen of some paragraphs. Qatīl, then, goes on:

The other is natural Persian (*fārsī-yi ṭab'ī*), in which they light heartedly (*bī-taḥqīq*) introduce in Persian expressions shared with the Hindi language (*alfāz-i mushtarak-i hindī zabān*), and this is wrong and extremely ugly and causes mockery. (Qatīl 1872, p. 19)

The linguistic declension of Āzar Baygdīlī's geography of the 'Ajam,<sup>28</sup> evoked above, is here completed. The third variety of Persian, sort of a supplement to the two *naw'*/types of Iran and Turan, is the Persian of Hindustan, to which Qatīl, notably enough, devotes an entire subsection of his book. First of all, Qatīl makes it clear once and for all that those Indians who like himself, being *muqallids* 'imitators' in the above-delineated meaning, have chosen to adapt to the Iranian standard and enjoy a privileged relationship with the reified category of the 'native speakers', are excluded from the group of the Indian Persian users. Two contrasting forms of Indian Persian are then quickly identified: an artificial, unchanging, book-based language, which is deemed «correct» (it is worth remembering here that the search for the «correctness of language», *siḥḥat-i zabān*, was identified by Qatīl as the pillar for a professional use of Persian) and a live, localized medium, which is, on the contrary, «wrong and ugly». The 'naturalness' of this language, directly expressed by Qatīl through the use of the adjective *ṭab'ī*, is further clarified by the adverbial expression *bī-taḥqīq*, which signals the absence of critical reflection and intellectual consciousness, *taḥqīq* having, in the Perso-Arabic traditional sphere of disciplines of knowledge (*'ulūm*), a well-known technical meaning indicating the 'scrutiny of truth', thus literally 'verification'. The natural, non-negotiated employment of Persian – outside what Antonio Gramsci will call the «conformism» of «non-written normative grammar» (Lo Piparo 1979, p. 250) – by its North Indian users, both in spoken and written form, Qatīl tells us, causes mockery:<sup>29</sup> presumably, the mockery of the native speaker,

---

28 I deliberately echo here the title of an illuminating essay by Sunil Sharma on the literary «boundaries of 'Ajam» in the early modern period (Sharma 2012).

29 To continue with the parallelism with Gramscian linguistic thought, in the same passage evoked above the Italian intellectual talks as well of parody and derision as instruments for ultimately determining a prevalence based on a «grammatical conformism». As Lo Piparo points out, Gramsci is elaborating concepts already expressed by Antoine Meillet and others (Lo Piparo 1979, pp. 250-1).

or, more correctly, of the imagined *model* native speaker and its locally embodied *muqallid*/imitator aliases. Suffice it here to mention, on the one hand, the sarcastic observations on Bīdīl's prose attributed by Āzād to 'Alī Ḥazīn (Āzād 1992, p. 212) and, on the other, the similar dismissive tones used by the late nineteenth century *tazkira*-writer from Lucknow Āftāb Rāy Lakḥnavī when referring to the same author.<sup>30</sup> The main reason for the condemnation of such linguistic practices, so widespread at the end of the eighteenth century to deserve a specific chapter in a general descriptive work on the correct use of Persian language, is identified by Qatīl in its tendency to employ «expressions shared with the Hindi language» (*alfāz-i mushtarak-i hindī zabān*). Qatīl's sentence is somehow ambiguous, and one is tempted to think of the influx of Hindi loanwords and go back, for instance, to Ārzū's discussions on the opportunity of using Hindi vocabulary while writing (and talking) in Persian.<sup>31</sup> However, not a single Hindi word can be found in the fourteen-line specimen provided by Qatīl to exemplify the 'natural' Persian of Hindustan. The two specimens, of the 'book' and of the 'natural' Indian Persian, are loosely distinguished by a respectively more formal and more colloquial tone and some variations in the use of Persian vocabulary (cf. Qatīl 1872, pp. 19-20). As a matter of fact, with the expression *alfāz-i mushtarak-i hindī zabān* Qatīl seems to be referring not so much to Indo-Aryan loanwords in Persian, but to the use, in Persian, of Persian words as they are used, or would be used, while talking and writing in Hindi/Urdu, and to the acclimatation of Persian in the North Indian linguistic environment.

### 3 Layered hegemonies in the *Nahr al-faṣāḥat*

Such views will be clarified a few years later by Qatīl himself in the *Nahr al-faṣāḥat*, where the peculiarities of the North Indian use will be tackled again, and in much more detail. In the very first chapter, devoted to describing some linguistic practices «that must be abandoned», Qatīl resumes:

It must be known that the common people of India (*'avāmm-i hind*), who do not have a clue how to use Persian, use some expressions which are the cause of mockery among native speakers. (Qatīl 1874a, p. 3)

<sup>30</sup> «Although there is still someone, among ignorant Indians, who considers him to be among the most sublime writers, he is absolutely worthless in the opinion of those who really know the Persian language. His Persian, like that of Nāṣir 'Alī [Sirhindī (d. 1694)], is worse than Hindī» (Āftāb Rāy Lakḥnavī 1976-82, 1, p. 123).

<sup>31</sup> On these and other related aspects of Ārzū's philology, see the ample analysis provided in Persian by Raḥīmpūr 2012 and in English by Dudney 2013.

The statement is followed by a substantial list (almost 50 specimens) of Persian words and expressions used in North India with meanings different from (sometimes in contrast with) those indicated by the same expression in Iran and the literary tradition, and some specific Indian uses. More in detail, the list includes, often with illustrative short sentences, interesting specimens of semantic changes (through processes of narrowing, specialization, metaphorization etc.) such as:<sup>32</sup>

5. North Indian uses (1)

<i>gusistan</i>	as a synonym of <i>shikastan</i> 'to break' (Ir. and lit. 'to destroy');
<i>durūghgū</i>	with the meaning of <i>ja'li</i> or <i>mašnū'i</i> 'fake', 'artificial' (Ir. and lit. 'liar');
<i>rāstgū</i>	used to mean <i>khwush'aql</i> or <i>garānbahā</i> 'of pure origin', 'precious' (Ir. and lit. 'truth-teller');
<i>barf</i>	to mean <i>yakh</i> 'ice', whereas the term indicates 'snow' elsewhere;
<i>farbih</i>	meaning 'fat' in the other varieties, used as a synonym of <i>jali</i> 'wide' and <i>gunda</i> 'thick';
<i>gazīdan</i>	(Ir. and lit. 'to bite') to mean <i>burīdan</i> 'to cut', and viceversa;
<i>kushtan</i>	(Ir. and lit. 'to kill') to mean <i>zadan</i> 'to hit', and viceversa;
<i>khālū</i>	to indicate the husband of the maternal aunt ( <i>khāla</i> ). Qatīl stresses that Iranians use the same term to indicate the mother's brother;
<i>īnjānib</i>	as a substitute of the personal pronoun <i>man</i> 'I', whereas, Qatīl informs the reader, the native speakers use the expression to mean <i>īn ṭaraf</i> '(in) this direction';
<i>ḥuqqa</i>	(originally meaning 'box') instead of <i>qalyān</i> 'water pipe';
<i>dādan</i>	'to give' in standard usage, instead of <i>kashīdan</i> 'to pull', 'to draw' in some expressions such as <i>surma dādan</i> 'to apply antimony' (Ir. <i>surma kashīdan</i> );
<i>jastan</i>	'to jump' in standard usage, as a substitute of <i>parīdan</i> 'to fly', 'to flutter', in some idiomatic expressions such as <i>jastan-i rukhsāra</i> (= <i>parīdan-i rukhsāra</i> ) 'the fading of the colour of the face' or <i>jastan-i chashm</i> (= <i>parīdan-i chashm</i> ) 'the throbbing of the eyelid';
<i>fishāndan</i>	(Ir. and lit. 'to scatter') with the meaning of <i>fahmānīdan</i> 'to make (sb.) understand';
<i>nihāda-am</i>	(Ir. and lit. 'I have put') with the meaning of <i>nigāh dāshta-am</i> 'I have kept';
<i>chasbīdan</i>	(Ir. and lit. 'to adhere', 'to stick') idiomatically substituting the verbs <i>rasīdan</i> 'to come', <i>guzashtan</i> 'to pass', <i>aṣar kardan</i> 'to make an impression', <i>nishastan</i> 'to sit', <i>farīb shudan</i> 'to be gulled'.

32 All the examples described in the following tables are taken from Qatīl 1874a, pp. 3-6.

In other cases, the examples point to Indian innovative uses or original coinages, such as:

6. North Indian uses (2)

	Explanatory terms provided by Qatīl
<i>kandān</i>	<i>kandan</i> 'to excavate';
<i>ikhvān ṣāḥib</i>	<i>barādar ṣāḥib</i> 'respectful brother';
<i>sabzifurūsh</i> 'greens-seller'	<i>bāngfurūsh</i> 'bang-seller';
<i>pājāma</i>	<i>zīrjāma</i> 'underwear';
<i>rawghan-i zard</i> 'yellow oil'	<i>rawghan-i gāv-i māda</i> 'cow oil', i.e. 'butter';
<i>rawghan-i siyāh</i> 'black oil'	<i>rawghan-i chirāgh</i> 'candle oil';
<i>āghājī</i>	<i>āghājān</i> 'beloved sir' (also 'grandfather').

One particular example, *kustihzan*, used in India, which according to Qatīl means *kusdihzan* (an abusive word literally indicating a man 'whose wife gives away her pussy'), signals as well the presence, in Indian Persian, of changes affecting consonantal features, in this case the shift from the voiced to the voiceless dental plosive /d/>/t/. Most notably, some of the examples provided by Qatīl show an influence (varying in degree from probable to obvious) of the North Indian vernacular milieu, not only through a direct influx of lexical material (cf. the above mentioned *āghājī*, a Persian-Hindi compound formed by P. *āghā* 'sir' + H. term of respect *jī*) but also through semantic and morpho-syntactical calques, as in the following cases:

7. North Indian uses (3)

<i>sukhan</i>	(Ir. and lit. 'word', 'speech') to indicate an action ( <i>fi'l va ḥarakat</i> ). Qatīl provides the following examples: Iranian Persian <i>pisar-i āghā taqī harrūz dar bayt al-luṭf mīravād u in ḥarakāt munāsib-i ḥāl-i ū nīst</i> / Indian Persian <i>pisar-i āghā payvasta harrūz dar bayt al-luṭf mīravād u in sukhanān munāsib-i ḥāl-i ū nīst</i> 'The son of Āqā Taqī goes everyday to the brothel and his actions/behaviours are not appropriate to his status' > cf. the use of H. <i>bāt</i> 'discourse', 'circumstance', 'question', etc.;
<i>az</i>	(Ir. and lit. 'from') instead of <i>bā</i> (Ir. and lit. 'with'). The examples given are: <i>fulān-i az fulān-i dushman-ast</i> 'some person is the enemy of some other person'; <i>az ū guftam</i> 'I told him'; <i>nān az murabbā-yi sīb khwurdam</i> 'I ate bread with apple jam' > cf. the use of H. <i>sē</i> 'from', 'with';
<i>kasī chīz</i>	corresponding to Ir. <i>hīch chīz</i> 'nothing'. He also mentions the expressions <i>kasī vajh</i> , <i>kasī vujūh-i</i> 'in no way' (personal pronoun <i>kasī</i> 'someone' used as a negative indefinite adjective) > cf. the use of H. pronoun <i>kōi-kisī</i> 'some(one)', any(one)';
<i>fardā</i>	(Ir. and lit. 'tomorrow') and <i>pasfardā</i> (Ir. and lit. 'the day after tomorrow') to mean <i>dīrūz</i> 'yesterday' and <i>parīrūz</i> 'the day after tomorrow' and viceversa > cf. the use of H. <i>kal</i> 'yesterday', 'tomorrow' and <i>parsom</i> 'the day before yesterday', 'the day after tomorrow';



<i>ki</i>	(Ir. and lit. 'who?') used instead of <i>chi</i> 'what?'. As an example, Qatīl provides the sentence <i>barāy-i ki kār mīravid</i> 'to what occupation are you going?' > cf. the use of H. <i>kaun</i> 'who', 'which', 'what';
<i>kudām</i>	(Ir. and lit. 'which?') instead of <i>ki</i> 'who?'. Qatīl provides the illustrative sentence <i>īn kudām-ast</i> «who is this?» > cf. H. <i>kaun</i> 'who; which; what';
<i>nūshīdan</i>	'to drink' in literary usage, instead of <i>kashīdan</i> 'to pull; to draw' to express the idea of inhaling smoke > cf. the use of H. <i>pīna</i> 'to drink'.
Third person plural	Qatīl mentions the use of the third person plural instead of the second person plural in verb conjugation. As an example Qatīl provides the following sentence: <i>shumā kujā rafta būdand va khwāhand raft</i> 'where had you gone and will go?' > cf. the use of H. honorific <i>āp</i> 'you' + plural verb;
Suffix <i>-yā</i>	Qatīl mentions the use of the final <i>yā</i> to produce feminine nouns: <i>ṣāḥibzādi</i> 'daughter of a notable' < <i>ṣāḥibzāda</i> 'son/daughter of a notable', <i>nūr-e chashmī</i> 'light of the eyes' (standard <i>nūr-i chashm</i> ) according to Qatīl «applied only to daughters and not to sons» > cf. the use of H. feminine ending <i>-ī</i> .

These testimonies are flanked by observations that show Qatīl's interest in reconstructing precise attributions of geographical appurtenance for Persian expressions commonly used in Hindustan: for instance, we are told that the term *bādfurūsh* 'idle talker', commonly substituted in Iran with the synonym *bādkhwān* and considered by some critics to be an Indian coinage, is actually a Central Asian term used by the Tajik poet Abū Naṣr Badakhshānī, who, Qatīl emphasises, never set foot in India. More in general, Qatīl's examples confirm that the objects of his discussion are not at all the more or less simplified lower forms of non-standard speech such as those attributed, for instance, to Baba Nanak (Shackle 1978; Orsini, Pellò unpublished), nor is the main problem the lexical influx of Hindi (which, on the contrary, is indeed pragmatically accepted by Qatīl as a logical fact when he comes to talk about Indian realities: Qatīl 1874a, p. 43), but rather a recognizable, shared and very diffused alternative standard of Persian, so important as to be considered as the third main variety of the entire geography of Persian, following the Iranian and the Turanian. Qatīl is interested in describing and criticizing the every-day Persian linguistic practices of the bilingual Hindustani *munshīs*, perceived as 'low' by him, but constituting as well his own socio-linguistic background and surroundings: as we shall verify further on as well, Qatīl's is the critical view of a purist consciously coming from an insider, a view which, significantly, gives the Hindustani variety an official space of recognition and an invaluable comparative recording while at the very same time officially dismissing it.<sup>33</sup> As a matter of fact, in the *Nahr al-faṣāḥat* Qatīl enlarges his critical

33 The following passage from the *Chār sharbat* is emblematic in exemplifying Qatīl's attitude towards purism: «You should have a look at their [Indian writers'] books: they have mixed together Arabic, Persian, Greek (*yūnānī*), Siriac (*sūryānī*), English (*angrezī*), Purābī and Panjābī, and have imagined that this is the language used by the people of Iran (*ahl-i*

survey of the internal linguistic hierarchies of the *'Ajam*, extending the comparative discussion to Iranian Persian. At the very beginning of the eight chapter, specifically devoted to the Persian language, Qatīl writes:

I would say that for the imitator (*muqallid*) of poetry both the Persian of Iran and that of Turan would work. But the language of the Azerbaijanis is better than that of the Turanians, and the people of Khorasan are better than those from Azerbaijan. Shirazis are better than Khorasanis and Isfahanis are better than anyone. (Qatīl 1874a, pp. 41-42)

Qatīl's rankings according to prestige would thus see the former Safavid capital Isfahan as the most authoritative centre,<sup>34</sup> followed, in order of importance, by Shiraz, Khorasan, Azerbaijan and Turan (where Kabul dominates over Balkh, as we have seen above). The following statements, however, further complicate the issue. First of all, Qatīl's analysis points to the recognition of a situation of diglossia within the world of Persian:

People from the higher and lower classes (*ashrāf va ajlāf*), from the mountains and from the cities, are all masters of the language (*ṣāhibzabān*). When it comes to speaking, a servant is equal to Mīrzā Ṣā'ib, and the language of both is authoritative. (Qatīl 1874a, p. 42)

Contrary to the Indian situation, where the 'natural Persian' of the local *munshīs* must be abandoned as the lowest possible variety, the 'natural Persian' of the speakers from Iran must be regarded as a source of imitation, irrespective of the social provenance of the source. However, the social equality of the Iranians, when it comes to spoken practices, and the authority that must be attributed to them and to the (new) Iranian standard, does not necessarily mean a blind endorsement of all the linguistic material coming from Iran:

However, some native speakers (*ahl-i zabān*), cannot pronounce some sounds correctly, just like the Indians. Actually, in every social group (*firqā*) and category (*ṣinf*) one can find people who cannot spell some

*Īrān*)» (Qatīl 1845, p. 43). While dismissing the local Hindustani usage, he is at the very same time showing off his unique connoisseurship as a Hindustani insider.

**34** Connecting such statements with the authoritative and persistent Arabic linguistic tradition in the Indo-Persian scholar's background, it is worth highlighting here that the discussions on the 'best variety' of Arabic go as far back as Ibn Jinnī and Ibn Fāris (tenth century), for whom the Quraysh are *aḥṣaḥu 'l-'arabi alsinatān wa aṣfāhum lughatan* «the best Arabic speakers as far as language is concerned, and with the purest dialect»; on the contrary Sībawayhi (8th c.), the author of the first Arabic grammar known to us, discusses the dialects of Arabic at length but shows no preference for this or that variety (Levin 1994, p. 215; see also Larcher 2004).

letters the correct way: some people cannot pronounce the *rā*, and others the *qāf*, and so on. In this case, the articulation of the word, even if it comes from a native speaker, is wrong (*ghalaṭ*), for instance *khalṭūm* instead of *kharṭūm* ‘proboscis’, *dīfār* instead of *dīvār* ‘wall’, *kāy u bāy* instead of *kār u bār* ‘affairs’ [...]. One can also find mistakes in meter and rhyme among the poets of Iran, who in this case are not reliable. (Qatīl 1874a, p. 42)

A critic looking for *faṣāḥat*, a ‘clarity of expression’ identified here in a fluent, non-artefact, non-anachronistic Persian language located on a circumscribed Iranian plateau and especially in its (now only symbolic) capital city, should also be able to criticize Iranian speakers and writers, be it for their innate or regional allophonic pronunciation, or for the technical flaws found in the true locus of linguistic institutionalization in the Persianate domain, i.e. the realm of poetry. Within such boundaries, and most notably within the boundaries of Iran, linguistic change and creativity is, nonetheless, envisaged and regulated:

The intervention (*taṣarruf*) introduced by them, i.e. to shape Arabic words into Persian forms and vice-versa, is correct, like *ṭalabīdan* ‘to seek’, *fahmīdan* ‘to understand’, *bal’īdan* ‘to swallow’ in the first case and *muzlaf* ‘curly haired’, *muzayyab* ‘adorned’, *nizākat* ‘tenderness’ in the second. Even if it is structurally wrong, a word is also to be accepted if it has been used by four very authoritative poets, or if ten good poets from Iran agree to it, or if its pronunciation is generally accepted. (Qatīl 1874a, p. 42)

A few years before, in the final part of the *Shajarat al-amānī*, Qatīl had dealt with the subject (the interventions and innovations applied to the Arabic lexical heritage and its use) with a less indulgent attitude, numbering them among the flaws of *faṣāḥat*, as being against the rules of *qiyās-i lughavī*, i.e. the linguistic paradigms of the (Arabic) grammatical tradition.<sup>35</sup> Here, on the authority of great «Iranian» masters of the past such as, for instance, Khāqānī (who operated in an interacting twelfth century Georgian-Byzantine-Seljuq Subcaucasian milieu), he accepts the very same usages as correct (*ṣaḥīḥ*): namely, constructing Persian verbs out of Arabic verbal nouns such as *ṭalabīdan* ‘to seek’ < A. *ṭalab* ‘quest’ + P. infinitive suffix *-īdan*, or shaping Arabic-like forms such as *nizākat* ‘tenderness’ by extracting trilateral roots from Persian words (in this specific case, the adjective *nāzūk* ‘delicate, subtle’) or attaching the Arabic article *al-* to Persian

35 See Qatīl 1872, pp. 20-21. Among the flaws contradicting the *qiyās-i lughavī* Qatīl enumerates as well some local uses of verbal forms (i.e. *gashtānīdan* instead of *gardānīdan* ‘to avert’) in Kabuli Persian ‘and by some Khorasanians’ (Qatīl 1872, pp. 20-21).

words in Arabic-Persian state-constructs such as *zū 'l-khwarshīdayn* 'the owner of the two suns', where the Arabic dual oblique suffix *-ayn* is also applied to the word of Iranian stock *khwarshīd* 'sun', etc. (Qatīl 1874a, p. 22). This is not at all a new discussion, having already been tackled, for instance, as far as the Indo-Persian context is concerned, in the widespread Mughal grammar by 'Abd al-Vāsī' Hānsavī<sup>36</sup> and in the philological works by Ārzū.<sup>37</sup> Qatīl, who is crafting a negotiated discourse on purism, is mainly interested in distinguishing who has the linguistic right of intervention and in what domains such rights might be applied. Place, time, and modalities of change and legitimization are made very clear in the ninth chapter, devoted to «the difference between the poetry of the ancients and the moderns, and the prose of the Indians and of the native speakers»:

The intelligent reader should know that the current linguistic usage (*rūzmarra*) of Iran changes every sixty years, and in every period sixty eloquent men gather together and apply new changes. Thus, the poetry which is composed according to the usage of the time, is not in the language of the ancients. The usage of the time consists of what the people of Iran employ when speaking [...]. In this respect, it is useless to consult the books; as for the Persian of Turan, it does not change, since the Turanians are not the owners of the language (*mālik-i īn zabān nabāshand*) and among them you will not find men eloquent in Persian (*fushāhā-yi fārsī*), except in poetry. (Qatīl 1874a, p. 42)

The rapid linguistic change and the related imaginary hyper-*majlis* of the 'Académie' of the Persian language, which takes place every sixty years in Iran, Qatīl suggests here, is what really marks the difference between the Iranian region and the rest of the Persophonie. Turan, imagined as the crystallized space of the great masters of the Central Asian past, is not where the «owners of the language» reside, since its language, contrastingly represented as immobile in an anachronistic archaicity, does not change. There is no usage of the time beyond the Iranian usage: being eloquent in Persian, consequently, means being able to adapt to the rapid linguistic change taking place in post-Safavid Iran. It is crucial to highlight

36 For 'Abd al-Vāsī' such linguistic facts are merely the object of a normative and performative description based on a perceived inclusive lay of the land: word production and linguistic innovations in Persian include for him, with no interruption and no identification of hierarchical actors, the Hindi as much as the Arabic influx, as exemplified by the juxtaposition of the Hindi-Persian form *chalīdan* 'to walk' to the parallel Arabic-Persian *ṭalabīdan* seen above etc. (Hānsavī 1884, pp. 39-40).

37 Ārzū's articulate treatment of the question in his *Muṣmir* includes dedicated discussions on Persianization (*tafrīs*) and Arabization (*ta'rīb*) as well as the legitimacy, for Indian literati, of making interventions in Persian (e.g. Ārzū 1991, pp. 161-175; 36-39; discussions in Pellò 2004 and Dudney 2013, pp. 113-118).

that Qatīl is not celebrating here the literary Persian of the ancient masters, nor indeed is he proposing any sort of *bāzgasht* or linguistic neo-classicism based on the projection of a localized 'glorious' past (the Khorasan of Samanid and Ghaznavid times); on the contrary, he is institutionalizing, from the dislocation of Shi'ite Awadh, a reconstructed present, founded on a new canonization of the current linguistic situation. To draw a parallel with Islamic (and especially Shi'ite) jurisprudence – which is, in fact, closely related to grammatical and rhetorical knowledge in the Arabic-Islamic tradition<sup>38</sup> – one could say that, for Qatīl, the door of linguistic *ijtihād* (the effort toward normative elaboration based on scriptural sources) is not at all closed. In the context of a virtual collective *majlis* where, as we have already observed, the Indian learners are called, using a technical term of Shi'ite *fiqh*, *muqallid* ('imitators', i.e. applying the principle of *taqlīd* 'imitation' of a juridical authority), the authoritative (Iranian) poets work like *mujtahids*, and the most authoritative among them function as sources of imitation (the idea of the *marja'-i taqlīd* will be institutionalized during the nineteenth century); or, alternatively, the 'general acceptance', again comparable to the legal principle of *ijmā'*, works as a normative rule to approve innovations and changes.

After having described some further peculiarities of Iranian Persian and having noticed that Iranians themselves use Hindi words if they have come to India (Qatīl 1874a, p. 43), Qatīl will conclude his discussion on the varieties of Persian in the second part of the tenth chapter, devoted, as we have already mentioned, to teaching how to write *inshā* prose. In line with the practical aim of the chapter, Qatīl articulates his concluding remarks while providing a pragmatic accommodation of the complex hierarchies described above, where the place of his native Hindustan, and especially of his own socio-professional background, is ultimately rescued through a stylistic categorization:

Prose can be either devoid of affectation or endowed with it. The one devoid of affectation can be of two kinds: that according to the native speakers, which is of course more elegant and elevated – but what can we do about that?, it is not commonly used (*ravāj nadārad*) in India and our *munshīs* (*munshiyān-i īnjā*), because of their ignorance of those idioms, even consider it of little value (*pūch shumārānd*) and have no understanding of it. Or it can be according to the people of India, and when we talk of the peculiarities of the people of India, we do not so much refer to the wrong or un-idiomatic expressions (*'ibārāt-i ghalāṭ u bī-muḥāvāra*), but mainly to the absence of discernment as far as the

38 Ṣābit ibn Qurra (ninth century) literally categorized *fiqh* as a branch of rhetoric (Walzer 1953, p. 128). On the openly-recognized interdependence of their disciplines by grammarians and lawyers from the end of the 8th century onwards, see Carter 1983.

Persian of Iran and Turan is concerned. Because Indians employed what they found in the books. (Qatīl 1874a, p. 44)

Whereas, when it comes to speech and conversation, a contained and centralized idea of Iran is for Qatīl the only plausible model to refer to, and, as far as poetry is concerned, a pale archaization of Central Asian/Afghan 'Turan' can still be contemplated, when *inshā* prose – the true subject of Qatīl's treatise – is finally tackled directly, Hindustan is notably the only other stylistic space to obtain Qatīl's quality certification as *bī-takalluf*, 'without affectation', albeit declaredly as a second choice following Iran. What distinguishes an acceptable Hindustani practice is the very same feature that marks its limits – i.e. the lack of a clear choice between Iran and Central Asia. For Qatīl, in other words, keeping in mind what he had said about the exclusion of Hindustani peculiarities, Indian Persian can either be 'natural' (*ṭab'ī*) but ugly and incorrect, or correct but bookish and detached from current standards, seen as prestigious. The reasons for such a situation are not only attributable to the inclination to rigidly adhere to the internal rhetorical requirements of poetry and prose (Qatīl 1874a, p. 44) but, more decisively, are social and historical as well:

[Because of] living outside the city or in the mountains or because of the admixture with the Turks or living in a town where Iranians and Turanians are mixed or choosing the service of the sultan of Turkestan and imitating their current usage [...], [Indian writers] have not distinguished between Iran and Turan and an artificial and non-artificial language. (Qatīl 1874a, p. 44)

Isolation and detachment from the metropolis, or, alternatively and complementarily, admixture with Central Asians in the metropolis, place the Indian writer in a limbo, suspended between the new, recasted Iranian standard and the archaic, immobile Turani model. The exclusion of the Central Asian varieties is articulated through their identification with the Turks and Turkestan, notwithstanding the Turkization of the Iranian Persian lexicon shown by Qatīl himself in his examples. India, for its part, is seen as the place of admixture, indetermination, and possibility of choice and, ultimately, accommodation:

Since the death of Ṣahīr al-Dīn Bābur and during the rule of the Mughals (*salṭanat-i Gūrkāniya*), and up to the present days in which the moon of this state is undergoing an eclipse, because of the bad nature and the black heart of the servants of this court [...] so many Iranians and Turanians came to Hindustan that the people residing in this country have lost the ability to distinguish between the Iranian and Turanian Persian, apart from those good-natured who can separate pure wine

from dregs. The writer of the current usage, then, must find fluency in the phrasing, and after having studied the Persian of Iran from the native speakers or from a proficient knower of the language, can use in his letters (*makātīb*) the standard which has become widespread in India – *people talk in the capacity of their intellects* – and use the standard of Iran if the interlocutor is a proficient knower of the language or a native speaker. To exemplify this subject, I shall write here two letters, following respectively the style (*bar vaḡʻ*) of the Iranians and that of the Indians, both being in a good and agile current language (*muḥāvāra*). (Qatīl 1874a, pp. 45-46)

The duty of the professional Indian *munshī* (personified in the text by Qatīl himself through the evocation of the «knower of the language» as the alternative authority to an Iranian speaker) is, thus, that of distinguishing among varieties and choosing the right register in view of the various typologies of interlocutors and spaces of linguistic articulation: the Hindustani philologist-secretary, Qatīl implicitly suggests, has the unique advantage of being able to commute easily between the two poles of Iranian and Hindustani varieties (perfectly translatable at this point as styles of expression), retaining in both cases the hegemony of a symbolic power identified here with the good taste of selecting an agile up-to-date standard.

#### 4 Qatīl's conversion and the linguistic idea of Iran

In a thoughtful and brilliantly documented article in Persian entitled «When did Persian become the colloquial language of Isfahan?», Habib Borjian has suggested that the predication of Shi'ism during the Safavid times, both in urban and in rural centers, is to be considered a key factor in the rapid regression of central Iranian dialects and their eventual virtual disappearance in favor of modern spoken Persian (Burjiyān 2013, pp. 105; 107). According to the Iranian linguist, the widespread diffusion of the public practice of *rawḡakhwānī*<sup>39</sup> gatherings during the sixteenth and seventeenth century process of religious uniformity of Iran helps, among other things, to explain the fact that «in the main cities of the central regions, such as Isfahan, Kashan and Yazd, the local dialects (*gūyishhā-yi*

---

39 The *rawḡakhwānī* is a public ritual during which a trained speaker retells mourning narratives from the battle of Karbalā, basing the narrative plot on texts such as the eponym *Rawḡat al-shuhadā* 'Garden of Martyrs' by Vā'iz-i Kāshifī (1502) but with a preponderance of improvisation and adaptation to the local audience. Some recent observations on this and other connected practices are found in Aghaie 2015, pp. 12-13, who also emphasizes their diffusion from the sixteenth century onwards.



*būmī*) have survived only among the Jewish and Zoroastrian residents, while Muslims use exclusively Persian» (Burjiyān 2013, p. 107). As a matter of fact, instances of the capillary use of a sort of Iranian *koine*, seen as departing from the cosmopolitan literary language, can be found in the religious literature of the Safavid times, as in the cases of the well-known Persian Qur'anic commentary *Minhāj al-ṣādiqīn* by Faḥr Allāh Kāshānī (1570-1) (Muṭahharī 1980, p. 61). Along similar lines, Shaykh Bahā al-Dīn 'Āmilī (1547-1621), the influent Lebanese scholar and *shaykh al-islām* of Isfahan during the time of Shāh 'Abbās, directly deals with the same linguistic issues in his *Jāmi'-i 'Abbāsī*, the first comprehensive work on jurisprudence in Persian. While explaining in the introduction the reasons for his choice of language, 'Āmilī writes:

In accordance with the noblest and most excellent command, this work and its contents were compiled and presented to the reader in clear and comprehensible idioms, so that everyone, from both the notables and the common people (*khavāṣṣ va 'avāmm*), might find and gain advantage from reading it. ('Āmilī n.d., 2-3)

'Āmilī's programmatic statements find further pragmatic confirmation in the popularization, for the same preaching reasons, of literary works such as the *Rawḥat al-shuhadā*, re-told and explained in a simplified language in public settings (Aghaie 2015, pp. 12-13). Such linguistic trajectories, conjuring up the pedagogical observations made by Ludovico Antonio Muratori (1672-1750) on the role of the *predicatore urbano* (urban preacher) and the diffusion of an «easy and propotionate» *comun parlare italiano* (common Italian speech) in the comparable multilingual milieu of post counter-reformation Italy (Formigari 1990, pp. 81-84),<sup>40</sup> are not without echoes in Qatīl's work. Writing from his North Indian observation point almost two centuries after 'Āmilī's Persianization of the Shi'ite traditions, Qatīl is reacting to a transformed linguistic situation well-described, again, by Borjān:

at least from Qajar times, the language of peddlers and preachers has been a reformed kind of literary language, and in the theological school only this language was used in teaching. [...] It is possible that [this situation] was the main reason for the progress of Persian in all the Iranian cities, starting from Shiraz, where literary Persian (*fārsī-yi darī*) took the place of the local variety (*fārsī-yi būmī-ash*). In the same way, Turkish took the place of Tati in Azerbaijan. (Burjiyān 2013, p. 107)

40 Muratori deals with such themes in two very influential works: *Riflessioni sopra il buon gusto* (Considerations on Good Taste) and *Pregi dell'eloquenza popolare* (Virtues of Folk Eloquence). On the subject see, also, D'Agostino 1989.

To put it in Gramscian terms, then, if «every hegemonic relation is necessarily a pedagogical relation»<sup>41</sup>, in a Lucknow declared *Dār al-shī'a* during the reign of Āṣaf al-Dawla (1775-1797) and traversed by the intellectual discourse of Shi'ite scholars and travellers from the nascent Qajar state, Qatīl's linguistic education can be said to respond, by re-thinking the position of the Indian *munshī*, to the formation of a new Iranian *koine*<sup>42</sup> and the socio-textual role of the 'fresh Persian speakers' (*fārsīgūyān-i tāza*) already perceived as crucial, for instance, by Ānand Rām Mukhliṣ in his lexicographic *Mir'āt al-iṣṭilāḥ*.<sup>43</sup> In this setting, Qatīl's relationship with Shi'ism and his superimposition of the latter on his idea of Iran play a significant role in the construction of his linguistic hierarchies and boundaries. The phraseology chosen by Qatīl to exemplify his grammatical teachings may serve as a preliminary illustration of this point. As a matter of fact, not only do we meet with openly stated indications of hierarchical superiority, such as in the sentence *Īrān-i mā bih az Tūrān-i shumā* 'Our Iran is better than your Turan' (Qatīl 1872, p. 14), but we also find a whole set of linguistic items and idioms which are identified and catalogued by Qatīl as examples of Iranian Persian and which actually refer directly to a Shi'ite religious and devotional sphere. The very rich first part of the second section of the *Chār sharbat* (Qatīl 1845, pp. 27-36), devoted to the «expressions of the native speakers» (*muṣṭalahāt-i ahl-i zabān*), includes several such examples. Among the usual obscene repertoire representing the language of the 'āvāmm, such as *jighla* defined as a «boy who is worth being fucked» (Qatīl 1845, p. 33), terms referring to specific places in Iran, such as the *bāgh-i naẓar* of Kerman (Qatīl 1845, p. 30), technical terms of the traditional *kushti* wrestling in the everyday life of the *vilāyat* (Qatīl 1845, pp. 30-31), etc., we find several instances of Shi'ite socio-religious vocabulary identified as Iranian: for instance, *ithnā'asharī* 'Twelver (Shi'ite)', *ja'farī* 'following the Shi'ite juridical school', *marṣiya* 'elegy (for the Imam)', *nawḥa* 'lament for Karbala's martyrs', *rawẓakhwān* explained by Qatīl as «the reader of the Muḥarram books», *pā'alamkhwān* explained as «the person who sings under the banner of the Imam during Muḥarram», *pāminbarī* explained as «the person who sits under the pulpit during the sermon»,

41 «Ogni rapporto di egemonia è necessariamente un rapporto pedagogico», the Sardinian thinker writes in the *Quaderno* 10 (Gramsci 1975, 2, p. 1331).

42 I am referring again to Gramsci's approach to the term, on which the discussion by Lo Piparo is, once more, illuminating (Lo Piparo 1979, p. 262).

43 Closely connected to the stylistic and socio-textual phenomenon of *tāzagūyī* 'new diction', Mukhliṣ declares that he uses this term to indicate the users of a contemporary diction as opposed to the «old» forms found in traditional lexicography. In Mukhliṣ's words, his aim is very different from that of the «lexicographers who have focused on the collection of old words (*luḡhāt-i qadīm*) and have not paid attention to the study (*taḥqīq*) of the expressions of the fresh Persian speakers (*fārsīgūyān-i tāza*)» (Mukhliṣ 2013, 1, p. 2).

*zākir* ‘the declaimer of deeds of the imam’, *gunbad-i mubārak* explained as «the mausoleum of the Imam» (lit. ‘blessed dome’), *khāk-i shifā* explained as «the ground of Karbalā» (lit. ‘ground of well-being’), *ṣāhib al-zamān* explained as «Imam Mahdi» (lit. ‘Master of time’), and so on (Qatīl 1845, pp. 32-34). In some cases, Qatīl’s observations reproduce indeed a sort of linguistic ethnography of early Qajar Iran, as in the description of *bijūsh* (sing. imp. of verb *jushīdan* lit. ‘to boil’) technically used in the context of a Muḥarram procession with the exhortative meaning of ‘be passionate!’, let’s strive hard!’:

it is the exclamation (*na’ra*) of the Twelvers (*ithnā’ashariyān*) when they beat their chest (*sīnazanī*), addressing those who have got tired [of mourning]. When the latter listen to these calls, they begin again to commit to their devotional duties. (Qatīl 1845, p. 35)

Against the same background, to add a further example, the emerging and polysemic Iranian urban social figure of the *lūṭīs* (which might be rendered here, very generally, as ‘street people’)<sup>44</sup> is connected in the text to a specific Iranian linguistic usage related to the performing space of the Muḥarram processions. While defining the technical use of the word *sang* ‘stone’, Qatīl writes:

In the jargon of the *lūṭīs*, it means *chakchakī*. It is that thing which is made of wood and which they beat in front of the ‘*alams* of the *īmām* during *muḥarram* and when they beat them they recite lines, but now the beating of *sang* is very widespread and both humble and noble ones beat the *sang*, with the only exception of the rulers and the dignitaries (*ṣāhib-i tamkīn u vaqār*), in Iran as well as in Hindustan. (Qatīl 1845, p. 35)

A slang use of the term *sang* in a non-privileged social context becomes an instrument, in Qatīl’s grammatical normative work, to promote the institutionalization of a new idea of Iran as well as to highlight the spread of a unifying Shi’ite devotional practice between the two poles of Qatīl’s world of Persian. Several other examples of the frequent normative use of words, idioms and expressions related to the Shi’ite religiolect can be found in all of Qatīl’s works, from the *Shajarat al-amānī*, where a Shi’ite-Sunni terminological diatribe is used to explain the rhetorical figure called *ihām* ‘anphibology’ (Qatīl 1872, p. 23), to the *Nahr al-faṣāḥat*, where various invocations to the Imams are used to illustrate the prestigious linguistic practice of a ‘model’ Persian (Qatīl 1874a, pp. 34, 63). In Qatīl’s letters,

<sup>44</sup> On the *lūṭīs* and their perceived image as a more or less organized guild ranging, with various degrees of overlappings, from street performers to romantic outlaws, see Floor 1971 and 2010.

among personal observations on how difficult it is to use spoken Persian and the choice of the best regional variety (Qatīl 1887, pp. 72-73), an exhortation to his younger friends to take advantage of the invaluable occasion to practice the language with native speakers from the *vilāyat* (Qatīl 1887, p. 69), and philological criticism directed towards himself as well as towards the «eloquent masters of Iran and Purab» who «also make mistakes» (Qatīl 1887, p. 72), we run into various situations related to a specific Iranian-Shi'ite linguistic and textual culture. An interesting case, beyond the numerous references to the Imams, the Shi'ite sacred places of Western Asia and the associated pilgrimages (Qatīl 1887, pp. 8, 14, 29, 52, 84, etc.), consists of the mention, among the books that Qatīl tells his interlocutors to have ordered from Iran for his own library in Lucknow (lamenting their high price), of some *kitābhā-yi imāmiya* 'Imamite books', among which he cites the *Ḥaqq al-yaqīn*, the collection of traditions by Muḥammad Bāqir Majlisī (1616-1698) and a Persian translation of Muḥaqqiq-i Ḥillī's (1205-1267) legal compendium *Sharā'i al-Islām* (Qatīl 1887, p. 61).<sup>45</sup>

A direct connection between Qatīl's conversion, Iran, and his linguistic choices is, after all, often made by *tazkira* literature itself.<sup>46</sup> Ghulām Hamadānī Muṣḥafī states:

The name of [Qatīl's] father was Dargāhī and he himself, then, was known as Dīvālī Singh.<sup>47</sup> When, according to the decree of fate, his parents moved to Fayzābād, he honoured himself by converting to Islam thanks to Mīrzā Muḥammad Bāqir Shahīd Iṣfahānī. He was eighteen years old [...]. Since at the time of the late ruler there were more Iranians than now, he chose this path [the Shī'ī *mazhab*] and his master bestowed upon him the *takhalluṣ* 'Qatīl': the master's name was Shahīd [i.e. 'martyr'], so the disciple had to be known as Qatīl [i.e. 'slain']. (Muṣḥafī 1934, p. 46)

According to Muṣḥafī, the young poet's conversion takes place primarily through the encounter with his *ustād* in Persian poetry: in the textualized

45 A Safavid copy of Rūmī's *maṣnavī*, on plain paper and with normal calligraphy would cost, according to an annoyed Qatīl, «sixty, seventy, eighty» rupees, whereas «at the time of Sulṭān Ḥusayn, the last Safavid ruler [...] nobody would have bothered to buy it, since even one rupee would have been a high price for it» (Qatīl 1887, p. 61).

46 I provide a richer anthology in Pellò (2012, pp. 161-8); the following notes are partially based on the material discussed there.

47 *Sic* in the 1934 printed edition of Muṣḥafī's text. Muḥammad 'Umar's Urdu translation of the *Haft tamāshā* has the form Dīvānī Singh (Qatīl 1968), which is found also in Alam and Subrahmanyam (2012, pp. 423-426; transcribed as Diwani Singh). Other sources, such as Anūsha (1996-2001, 3, 2032-2034), state that Qatīl's name previous to conversion was Dīvālī Singh.

dimension of Qatīl's literary figure, the bestowing of his poetical *takhallus* indicates at the same time his new identity as a Persian writer and his new identity as a Shi'ite faithful,<sup>48</sup> both mediated by the dominant presence of Iranians in Awadh. Developing this motif, by mid nineteenth century Najm-i Ṭabāṭabā'ī will write, in his *tazkira Nagma-yi 'andalīb* (1845):

When Muḥammad Bāqir decided to go back to his native country, the youth felt the desire to go with him. He thus visited Iran, and learnt the language of the people there, with a great passion. He was not even seventeen when he accepted Islam and declared his own conversion. When he came back from Iran his father was still alive, but he abandoned his household to follow his love for Twelver Shi'ite Islam. (Najm-i Ṭabāṭabā'ī MS, f. 149v)

An identification of linguistic Persianization with religious conversion is delineated, the critical point being Qatīl's learning of the prestigious Iranian variety during what is depicted in the text as a revealing study-pilgrimage to the *vilāyat*. The conversion and his trip to Iran to learn the language – the latter is a leading *topos* also in the biographies of other Indo-Persian writers of scribal background such as his ancestor Siyālkotī Mal Vārasta and Tek Chand Bahār<sup>49</sup> – are indeed the main axes along which Qatīl is read during the nineteenth century: similar statements can be found in several other Indo-Persian texts looking at Iran through the mirror of the Qajar state, for instance in the *Khāzin al-shu'arā* – completed in 1848, at the onset of Nāṣir al-Dīn Shāh's reign – where the core of the biographical entry devoted to Qatīl again makes a close connection between his abandoning of the 'deep darkness of infidelity' and his learning, while in the *vilāyat*, of the local variety of Persian (Mīrānjān Ajmalī MS, f. 123r). Writing at the end of the 1930s, Sayyid 'Alī Anvarī Farīdābādī shows quite clearly the persistence of such readings: «He converted to Islam because he was passionately in love with the Persian language, choosing for this very reason the way of the Shī'a» (Anvarī Farīdābādī 1939, p. 119). Beyond the trope of Qatīl's linguistic conversion, and against the background of a rapid process of nationalization of the linguistic-literary traditions, it is worth remembering, in conclusion, that Qatīl's tendency towards purism, centralization and hierarchization is not limited to Persian and Iran, but applies to all the cultural-linguistic domains he deals with, beginning with the Hindi-Urdu and including the Turkish sphere as well:

48 For other 'literary' conversions in the same environment, see Pellò 2015.

49 On these probably fictional trips, whose symbolic value should not in any case be overlooked, see, respectively, the articulate comments by Shamīsā in Vārasta 2001, pp. 32-33 and the note by Dizfūliyān, who mentions the *tazkira Gulzār-i Ibrāhīm* as a source, in Bahār 2001-2002, *chahārdah*.

consider, for instance, the introductory discussions on the absolute linguistic dominance of the varieties used in the «capitals» (*qarārgāh-i arkān-i dawlat-i pādshāhī*) of *Rūm*, *Īrān* and *Hindūstān*, identified respectively in Istanbul (some European grammars would support the same opinion ca. twenty years later<sup>50</sup>), Isfahan and Shāhjahānābād in the *Daryā-yi laṭāfat* (Inshā 1916, p. 1); or the systematic attitude, in the *Haft tamāshā*, towards correcting the wrong pronunciation, by people from Iran, of Hindi terms containing specific sounds like the aspirate and the retroflex consonants, which «don't come out clear [...] from the Iranians» and which are, in the second case, exclusive to the «Afghans, the English and the Indians» (Qatīl 1875, pp. 6, 8). In a late eighteenth and early nineteenth century world of connected philologies and competing educational systems,<sup>51</sup> Qatīl's 'official' discourse on language from the state of Awadh – more or less contemporary to the abbé Gregoire's declarations on the abolition of patoises and the linguistic unification of France<sup>52</sup> – reconstructs an organic and hierarchicized space of centralized *langues* and varieties, dominated by the search for *faṣāḥat*, 'eloquent clarity' but also the capacity to be adequate to the context: every attempt on the part of Indians to forcibly look Iranian (*tamaghghul*) is, one should bear in mind, judged very negatively by the

50 Observations on the 'superiority' of the variety of Constantinople can be found in the *Grammaire théorique et pratique de la langue turke* by Artin Hindoglu (Paris, 1834; the text is a translation from a previous German version dated 1829) and in the older *Éléments de la grammaire turke* by Amédée Jaubert (1823), where the author writes: «Il seroit absurde de supposer qu'une langue répandue sur un aussi grand espace, n'éprouvât pas, selon la diversités des lieux, de nombreuses variations d'idiomes; aussi le turk qu'on parle dans la Romélie, par exemple, diffère beaucoup de celui de la Natolie, et sur-tout du turk parlé dans les pays qu'arrose l'Halys, dans ceux que traverse l'Araxe, et dans les lieux où l'Euphrate et le Tigre prennent leur source: néanmoins, nous pouvons affirmer, d'après notre propre expérience, que cette différence n'est pas comparable à celle qui existe les dialectes du français dans quelques-unes de nos provinces. Il faut observer, d'ailleurs, qu'en Turquie, comme par-tout où des conquérans pei éclairés ont porté leurs mœurs et leurs lois, la langue primitive des habitans ne s'est point perdue. Ainsi le peuple parle l'arabe à Alger, à Tunis, en Égypte et en Syrie; divers dialectes du slave en Bosnie, en Illyrie, en Serbie, en Bulgarie; le valaque au-delà du Danube; le grec en Morée, dans l'Archipel, à Constantinople et à Smyrne; enfin l'arménien et le kurde en Asie: et néanmoins, dans toutes ces contrées, on ne rencontre pas un homme tant soit peu instruit, qui n'entende et ne parle le turk. *Mais c'est à Constantinople, centre des affaires de ce vaste empire, et sur-tout parmi les personnes de la cour et les dames turkes de cette capitale, qu'il faut chercher la pureté, la douceur et l'élégance du langage*» (Jaubert 1823, p. 4; italics mine). I am, once again, grateful to Matthias Kappler for drawing my attention to these works.

51 Qatīl, who very often makes reference to the British in his letters and elsewhere, explicitly mentions the name of 'Mister John Lumsden' (*mistar jān lūmsdīn*) – a director of the East India Company and the elder brother of Matthew Lumsden, professor of Persian and Arabic at Fort Williams and the author of a grammar of the Persian language in English – in the *Nahr al-faṣāḥat* (Qatīl 1874a, p. 47).

52 I refer here to the *Rapport sur la nécessité et les moyens d'anéantir les patois et d'universaliser l'usage de la langue française* (1794) (see Brunot 1967, I; 204-14).



Khatri linguist (Qatīl 1872, p. 16; translation above). Instead of oversimplifying with quasi-pathological charges of 'Iranophilia' or forced ethnographic identifications, it would probably be more productive to begin saying that by officially establishing hierarchies and drawing boundaries, the ideal polyglot *munshī*-philologist from Hindustan embodied by Qatīl, comfortably moving through the varieties both as a legitimized connoisseur and as a local intellectual, retains the privilege of having his authoritative say on linguistic pedagogy, thus projecting the professional world of the North Indian scribes into a rapidly transforming, uncertain future.

## Bibliography

### Primary sources

- 'Abd al-Rashīd (1958). *Farhang-i Rashīdī*. Ed. by M. 'Abbāsī. 2 vols. Tih-rān: Kitāb-furūshī-yi Bārānī, 1337.
- Abū Ṭālib ibn Muḥammad Iṣfahānī (MS). *Khulāṣat al-afkār*. London, British Library, I.O. Islamic 2692.
- 'Āmilī, Bahā al-Dīn Muḥammad ibn Ḥusayn (Shaykh Bahā'ī) (s.d.). *Jāmi'-i 'Abbāsī: Yakdawra-yi fiqh-i fārsī*. Tih-rān: Intishārāt-i Farāhānī.
- Āftāb Rāy Lakhnavī (1976-1982). *Riyāz al-'arifīn*. Ed. by S.Ḥ. Rāshidī. 2 vols. Islāmābād: Markaz-i taḥqīqāt-i fārsī-yi Irān va Pākistān.
- Ārzū, Sirāj al-Dīn 'Alī Khān (1991). *Muṣmir*. Ed. by Rīḥāna Khātūn. [Karachi]: Instīṭiyūṭ auf Sanṭral ainḍ Vest Aishiyan Iṣṭāḍīz, Karāchī Yūnīvarsitī.
- Āzād, Mawlānā Muḥammad 'Alī (1992). *Nigāristān-i Fārs*. Delhi: Aakif Book Depot.
- Bahār, Lāla Tek Chand (2001-2002). *Bahār-i 'ajam*. Ed. by K. Dizfūliyān. 3 vols. Tih-rān: Ṭalāya, 1380.
- Burhān, Muḥammad Ḥusayn ibn Khalaf Tabrīzī (1964). *Burhān-i qāṭi'*. Ed. by M. Mu'in. 5 vols. 2nd ed. Tih-rān: Amīr Kabīr, 1342.
- Ḥabīb Iṣfahānī, Mīrzā (1892). *Dabistān-i pārsī*. Istānbūl: Chāpkhana-yi Maḥmūd Bak.
- Hānsavī, 'Abd al-Vāsī' (1884). *Risāla-yi 'Abd al-Vāsī'*. Kānpūr: Naval Kishor.
- Ḥazīn Lāhījī, Muḥammad 'Alī ibn Abī Ṭālib (1998). *Rasā'il-i 'Ḥazīn-i Lāhījī'*. Ed. by 'A. Awjabī et al. Tih-rān: Āyina-yi Mīrās, 1377.
- Hidāyat, Rizā Qulī Khān (1871). *Farhang-i anjumanārā-yi Nāṣirī*. Tih-rān: 'Alīqulikhān, 1288. Repr.: Kitāb-furūshī-yi Islāmiya.
- Hindī, Bhagvān Dās (1958). *Safīna-yi Hindī*. Ed. By S. Shah Md. Aatur Rahman. Patna: The Institute of Post Graduate Studies & Research in Arabic and Persian.
- Injū Shīrāzī, Mīr Jamāl al-Dīn Ḥusayn (1980). *Farhang-i Jahāngīrī*. Ed. by R. 'Afīfī. 3 vols. Mashhad: Dānishgāh-i Mashhad, 1359.



- Inshā, Inshā Allāh Khān (1916). *Daryā-yi laṭāfat*. Lakhna'ū: al-Nāẓir Pres. Mīrānjān Ajmalī, Sayyid 'Alī Kabīr (MS). *Khāzin al-shu'arā*. London, British Library, I.O. Islamic 3899.
- Mukhlīṣ, Anand Rām (2013). *Mir'āt al-iṣṭilāḥ*, 2 vols. Ed. by Shekhar, C., Qilīch'khānī, H.R.; Yūsufdiḥī, H. Dihlī: Dillī Kitāb Ghar.
- Muṣḥafī, Ghulām Hamadānī (1934). *Iqd-i Ṣurayyā*. Ed. by Abdul Haq. Aurangabad: Anjuman Taraqqi-yi Urdu.
- Nāṣir-i Khusraw (1972). *Safarnāma-yi Nāṣir-i Khusraw*. Ed. by Nādir Vazīnpūr. Tih-rān: 'Ilmī va farhangī, 1350.
- Najm-i Ṭabāṭabā'ī, Muḥammad Riḏā (MS). *Naghma-yi 'andalīb*. London, British Library, Or. 1811.
- Navāb, Sayyid Ṣadīq Ḥasan Khān (1875). *Sham'-i anjuman*. Bhopal: Maṭba'-i Shāhjahānī, 1292.
- Qatīl, Muḥammad Ḥasan (MS). *Dīvān*. Rampur, Rampur Raza Library, n. 3197 *mīm*.
- Qatīl, Muḥammad Ḥasan (1845). *Chār sharbat*. [Lucknow]: Muḥammadī, 1261.
- Qatīl, Muḥammad Ḥasan (1872). *Shajarat al-amānī*. [Kānpūr]: Maṭba'-i Ṣamar-i Hind.
- Qatīl, Muḥammad Ḥasan (1874a). *Nahr al-faṣāḥat*. Kānpūr: Naval Kishor.
- Qatīl, Muḥammad Ḥasan (1874b). *Maḏhar al-'ajā'ib*. Lakhna'ū: Naval Kishor.
- Qatīl, Muḥammad Ḥasan (1875). *Haft tamāshā*. Lakhna'ū: Naval Kishor.
- Qatīl, Muḥammad Ḥasan (1887). *Ruq'āt-i Mirzā Qatīl*. Kānpūr: Naval Kishor.
- Qatīl, Muḥammad Ḥasan (1968). *Haft tamāshā*. Urdu trans. by Muḥammad 'Umar. Dehli: Maktaba-yi Burhān.
- Vārasta, Siyālkotī Mal (2001). *Muṣṭalaḥāt al-shu'arā*. Ed. by Sīrūs Shamīsā. Tih-rān: Firdaws, 1380.

## Secondary sources

- Aghaie, Kamran Scot (2004). *The Martyrs of Karbala: Shi'i Symbols and Rituals in Modern Iran*. Seattle; London: University of Washington Press.
- Alam, Muzaffar; Subrahmanyam, Sanjay (2012). «Eighteenth-Century Historiography and the World of the Mughal *Munshī*». In: Alam, Muzaffar; Subrahmanyam, Sanjay, *Writing the Mughal World: Studies on Culture and Politics*. New York: Columbia University Press, pp. 396-428.
- Anūsha, Ḥasan (ed.) (2001). *Dānishnāma-yi adab-i fārsī: Adab-i fārsī dar shibh-i qārā (Hind, Pākistān, Banglādīsh)*. 1 vol. in 3 pts. Tehran: Vizārat-i Farhang wa Irshād-i Islāmī, 1380.
- Anvarī Farīdābādī, Asad 'Alī (1939). *Qatīl aur Ghālib*. Dihlī: Maktaba-yi Jāmi'a.

- Bartoli, Matteo Giulio (1910). *Alle fonti del neolatino*. Trieste: Stabilimento artistico tipografico G. Caprin.
- Blochmann, Henry (1868). «Contributions to Persian Lexicography». *Journal of the Royal Asiatic Society of Bengal*, 37 (1), pp. 1-72.
- Burjiyān, Ḥabīb (2013). «Zabān-i guftār-i shahr-i Iṣfahān kay va chigūna Fārsī shud?». *Zabānhā va gūyishhā-yi Īrānī*, 3, Isfand 1392, pp. 91-109.
- Brunot, Ferdinand (1967). *Histoire de la langue française des origines a nos jours*. Tome 9, vols. 1-2. Paris: Colin.
- Carter, M.G. (1983). «Language Control As People Control in Medieval Islam: The Aims of the Grammarians in Their Cultural Context». *Al-Abhath*, 31, pp. 65-84.
- Chodzko, Alexandre (1852). *Grammaire Persane, ou principes de l'iranien moderne*. Paris: A l'imprimerie nationale.
- D'Agostino, Mari (1989). «Parlare alla moltitudine: Questione linguistica e questione religiosa nell'Italia del Settecento». In: Formigari, Lia; Di Cesare, Donatella (eds.), *Lingua tradizione rivelazione: Le Chiese e la comunicazione sociale*. Casale Monferrato: Marietti, pp. 175-195.
- Dudney, Arthur Dale (2013). *A Desire for Meaning: Ḳhān-i Ārzū's Philology and the Place of India in the Eighteenth Century Persianate World* [unpublished Ph.D. dissertation]. New York: Columbia University.
- Faruqi, Shamsur Rahman (1998). «Unprivileged Power: The Strange Case of Persian (and Urdu) in Nineteenth Century India». *The Annual of Urdu Studies*, 13, pp. 3-30.
- Floor, Willem M. (1971). «The lūṭīs - A social phenomenon in qājār Persia: A Reappraisal». *Die Welt des Islams*, 13 (1-2), pp. 103-120.
- Floor, Willem M. (2010). s.v. «Luṭī». In: *Encyclopaedia Iranica* [online]. Available at <http://www.iranicaonline.org/articles/luti> (2016-06-30).
- Formigari, Lia (1990). *L'esperienza e il segno: La filosofia del linguaggio tra Illuminismo e Restaurazione*. Roma: Editori riuniti.
- Gramsci, Antonio (1975). *Quaderni del carcere*. 2 vols. Ed. by Valentino Gerratana. Torino: Einaudi.
- Ḥabīb Iṣfahānī, Mīrzā; Pellò, Stefano (ed. and trans.) (2003). *Dabistān-i pārsī: Una grammatica persiana del XIX secolo*. Venezia: Cafoscarina.
- Ḥabīb Iṣfahānī, Mīrzā; Énard, Mathias (ed. and trans.) (2004). *Epître de la Queue, suivi de douze séances salées de Mohammad ibn Mansūr al-Hilli*. Paris: Éditions Verticales; Le Seuil.
- Hadi, Nabi (1995). *Dictionary of Indo-persian Literature*. New Delhi: Indira Gandhi National Centre for the Arts.
- Jaubert, Amédée (1824). *Éléments de la grammaire turke*. Paris: Imprimerie Royale.
- Jones, Sir William (1807). *The Works of Sir William Jones*, vol. 5. London: Printed for John Stockdale, Piccadilly, and John Walker, Paternoster-Row.

- Khānlārī, P.N. (2003-2004). *Tārīkh-i zabān-i fārsī*, vol. 1, *chāp-i haftum*. Tīhrān: Farhang-i nashr-i naw, 1382.
- Kia, Mana (2014). «Imagining Iran Before Nationalism: Geocultural Meanings of Land in Azar's *Atashkada*». In: Aghaie, Kamran Scot; Afshin Marashi (eds.), *Rethinking Iranian Nationalism and Modernity*. Austin (TX): University of Texas Press, pp. 89-112.
- Kia, Mana (unpublished). «The Imagined Place of Indo-Persian: Collaboration, Translation and Circulation in the Subcontinent and Beyond». Paper presented at conference *Polyvocal Hindustan: Literatures, Languages, and Publics* (Stanford [CA], Stanford University, March 6-7, 2015).
- Larcher, Pierre (2004). «Theologie et philologie dans l'islam medieval: relecture d'un texte celebre de Ibn Faris». *Cahiers de l'ILSL*, 17, pp. 101-114.
- Landau, Justine (2013). *De rythme & de raison: lecture croisée de deux traités de poésie persans du XIIIe siècle*. Paris: Presses Sorbonne nouvelle.
- Lazard, Gilbert (1971). «*Pahlavi, Pārsi, Dari*. Les Langues de l'Iran d'Après Ibn al-Muqaffa'». In: Bosworth, CE (ed.), *Iran and Islam: In Memory of the Late Vladimir Minorsky*. Edinburgh: Edinburgh University Press, pp. 361-391.
- Levin, Aryeh (1994). «Sībawayhi's Attitude to the Spoken Language». *Jerusalem Studies in Arabic and Islam*, 17, pp. 204-243.
- Lo Piparo, Franco (1979). *Lingua, Intellettuale, Egemonia in Gramsci*. Roma; Bari: Laterza.
- Lumsden, Matthew (1810). *Grammar of the Persian Language, Comprising a Portion of The Elements of Arabic Inflection*. 2 vols., vol. 1. Calcutta: Printed by T. Watley.
- Mackridge, Peter (2009). *Language and National Identity in Greece, 1766-1976*. Oxford; New York: Oxford University Press.
- Marshall, D.N. (1967). *Mughals in India; a Bibliographical Survey*. Bombay, New York: Asia Pub. House.
- Mpampiniotes, Georgios (1998). *Lexiko tes neas ellenikes glossas: me scholia gia te soste chrese ton lexeon: ermeneutiko, etymologiko, orthographiko, synonymon-antitheton, kyrion onomaton, epistemonikon oron, akronymion*. Athena: Kentro Lexicologias.
- Munzavī, Aḥmad (1983-1997). *Fihrist-i musharak-i nuskhahhā-yi khaṭṭī-i Fārsī-i Pākistān*. 14 vols. Islāmābād: Markaz-i Taḥqīqāt-i Fārsī-i Īrān va Pākistān.
- Orsini, Francesca (2012). «How to do Multilingual Literary History? Lessons from Fifteenth- and Sixteenth-Century North India». *Indian Economic and Social History Review*, 49 (2), pp. 225-46.
- Orsini, Francesca; Pellò, Stefano (unpublished). «Bhakti in Persian». Paper read at the *21st European Conference on Modern South Asian Studies* (Bonn, 26-29 July 2010).

- Pellò, Stefano (2003). *La teoria della qāfiya nel «Mizān al-afkār» di Muḥammad Sa'd Allāh-i Murādābādī*. Venezia: Cafoscarina.
- Pellò, Stefano (2004). «Persiano e *Hindī* nel *Muḥmir* di Sirāj al-Dīn 'Alī Xān Ārzū». In: Favaro, Rudy; Cristoforetti, Simone; Compareti, Matteo (eds.), *L'onagro maestro: Miscellanea di fuochi accesi per Gianroberto Scarcia in occasione del suo LXX sadè*. Venezia: Cafoscarina, pp. 243-272.
- Pellò, Stefano (2012). *Tūṭiyān-i Hind. Specchi identitari e proiezioni cosmopolite indo-persiane (1680-1856)*. Firenze: Società Editrice Fiorentina.
- Pellò, Stefano (2015). «Drowned in the Sea of Mercy: The Textual Identification of Hindu Persian Poets from Shi'ī Lucknow in the *Tazkira* of Bhagwān Dās «Hindī»». In: Dalmia, Vasudha; Munis D. Faruqui (eds.), *Religious Interactions in Mughal India*. New Delhi: Oxford University Press, pp. 135-158.
- Perry, John; Windfuhr, Gernot (2009). «Persian and Tajik». In: Windfuhr, Gernot (ed.), *The Iranian Languages*. Abingdon (NY): Routledge, pp. 416-544.
- Pritchett, Frances W. (2003). «A Long History of Urdu Literary Culture, Part 2, Histories, Performances, and Masters». In: Pollock, Sheldon (ed.), *Literary Cultures in History: Reconstructions From South Asia*. Berkeley; Los Angeles; London: University of California Press, pp. 864-911.
- Quraishi, Waheed (1969). *Oriental Studies: The Indian Persian and Other Essays*. Lahore: Zarreen Book Agency.
- Raḥīmpūr, Mahdī (2012). *Bar khwān-i Ārzū: Guftārḥā-yī dar zamīna-yi nazāriyahā-yi adabī va zabānshinākhtī-yi Sirāj al-Dīn 'Alī Khān-i Ārzū*. Qum: Nashr-i Majma'ī Zakhā'ir-i Islāmī, 1391.
- Rieu, Charles (1881). *Catalogue of the Persian Manuscripts in the British Museum*, vol. 2. London: British Museum.
- Rotolo, Vincenzo (1965). *A. Korais e la questione della lingua in Grecia*. Palermo: Presso l'Accademia.
- Shackle, Christopher S. (1978). «Approaches to Persian loans in the *Adi Granth*». *BSOAS*, 41 (1), pp. 73-96.
- Sharma, Sunil (2012). «Redrawing the Boundaries of 'Ajam in Early Modern Persian Literary Histories». In: Amanat, Abbas; Vejdani, Farzin (eds.), *Iran Facing Others: Identity Boundaries in a Historical Perspective*. New York: Palgrave Macmillan, pp. 49-62.
- Spooner, Brian (2010). «Persian, Farsi, Dari, Tajiki: Language Names and Language Policies». In: Schiffmann, Harold F. (ed.), *Language Policy and Language Conflict in Afghanistan and Its Neighbors*. Leiden; Boston: Brill, pp. 89-117.
- Sprenger, Aloys (1854). *A Catalogue of the Arabic, Persian and Hindu'sta'ny Manuscripts, of the Libraries of the King of Oudh, Compiled under the Orders of the Govt. of India by A. Sprenger*, vol. 1, *Containing Persian & Hindu'sta'ny Poetry*. Calcutta: Printed by J. Thomas.

- Tavakoli-Targhi, Mohamad (2001). «The Homeless Texts of Persianate Modernity». *Cultural Dynamics*, 13 (3), pp. 263-291.
- Vejdani, Farzin (2015). *Making History in Iran. Education, Nationalism, and Print Culture*. Stanford: Stanford University Press.
- Walzer, R. (1953). «New Lights on the Arabic Translations of Aristotle». *Oriens*, 6, pp. 91-142.
- Muṭahharī, Murtaẓā (1980). *Khadamāt-i mutaḡābil-i Islām va Īrān*. Chāp-i duvvum. Tihrān: Intishārāt-i Ṣadrā, 1359.
- Zipoli, Riccardo (1996). «Elementi osceni nella lessicografia neopersiana». *Annali di Ca' Foscari*, 35, serie orientale 27, pp. 249-289.
- Zipoli, Riccardo (1999). «Le quattro stagioni della vulva: un *mathnawī* satirico-osceno di Mīrzā Ḥabīb Iṣfahānī». In: Scarcia, Gianroberto (a cura di), *Bipolarità imperfette*, Venezia: Cafoscarina, pp. 179-210.
- Zumurrudiyān, R. (2000). «Shams-i Qays-i Rāzī, nukhustīn dastūrī-yi zabān-i fārsī». *Majalla-yi zabānshināsī*, 15 (1), 1379, pp. 53-63.

## **5 On the Limes**





## **Borders**

Itineraries on the Edges of Iran

edited by Stefano Pellò

# **A World In-between**

## **The Pre-Islamic Cultures of the Hindu Kush**

Augusto S. Cacopardo

(Università degli Studi di Firenze, Italia)

**Abstract** The vast mountain area stretching east of the Panjshir valley in Afghanistan to the borders of Kashmir was, in pre-Islamic times, a homogenous culture area nested between the Iranian and the Indian worlds. Its inhabitants – speakers of a variety of Indo-European languages belonging mainly to the North-West-Indo-Aryan (or Dardic) and Nuristani groups – practiced related forms of polytheism differing in many traits but clearly united by a basic pastoral ideology encompassing all aspects of human life as well as the environment itself. The advance of Islam into the mountains, starting from the sixteenth century, gradually brought about the conversion of the whole area by the end of the nineteenth, with the sole exception of the Kalasha of Chitral who still practice their ancient religion to this day. Scholars who studied the area with a comparative approach focused mainly on the cultural traits connecting these cultures to India and especially to the Vedic world. Limited attention has been given to possible Iranian connections. The present article, on the basis of a recent in-depth investigation of the Kalasha ritual system, extends the comparison to other components and aspects of the Indian world, while providing at the same time some new data suggesting ancient Iranian influences.

**Summary** 1 The Kafirs of the Hindu Kush and the Advance of Islam in the Mountains. – 2 Comparative Research in Peristan: the Indian World. – 3 Comparative Research in Peristan: the Iranian World. – 4 Kalasha Religion. A Comparative Approach: Indian Traits. – 5 Kalasha Religion. A Comparative Approach: Iranian Traits

**Keywords** Kafiristan. Nuristan. Hindu Kush. Pre-Islamic. Kalasha.

### **1 The Kafirs of the Hindu Kush and the Advance of Islam in the Mountains**

The vast mountain area stretching east from the Panjshir valley in Afghanistan across the Northern Areas of Pakistan to the borders of Kashmir, was largely non-Islamic still at the beginning of the nineteenth century (Rennell 1792, p. 164; Elphinstone [1815] 1969, p. 618). Geographically, this area includes, to the west, the Afghan province of Nuristan, the Chitral-Kunar valley, the upper Dir and Swat valleys, in the Pakistani province of Khyber Pakhtunkhwa, with water courses all tributaries of the Kabul river; and to

---

#### **Eurasiatica 5**

DOI 10.14277/6969-100-3/EUR-5-10

ISBN [ebook] 978-88-6969-100-3 | ISBN [print] 978-88-6969-101-0 | © 2016

the east, the basin of the Gilgit river with the upper reaches of the Indus basin. In other words, the southern ramparts of the Hindu Kush chain and of the western Karakoram range. The inhabitants of the region, then called Kafiristan by the Muslims in all its extension, practiced archaic polytheistic religions which, though differing in many traits – such as the names of divinities, the morphology of religious festivals, the contents of the mythologies – had at their core a common symbolic system based on what has been termed a ‘pastoral ideology’ (Parkes 1987), which attached positive values of human solidarity and harmony with the spirits of nature to the male sphere of goat-herding deemed to be pure, and opposed negative values of individual appropriation and manipulation of nature to the female sphere of agriculture, considered impure; a dichotomy that was projected on the natural environment, consequently subdivided into ritually ‘pure’ and ‘impure’ spheres (Cacopardo A.M. 1985; cf. Jettmar 1975, pp. 216-220). Even if greatly diversified linguistically and ethnically, this vast mountain fastness was therefore characterized in pre-Islamic times by a certain degree of cultural homogeneity that allows to identify it as a distinct unit, a former ‘culture area’ to which, for the sake of convenience, we have elsewhere referred to as ‘Peristan’ (Cacopardo, Cacopardo 2001, pp. 25-28) (fig. 1).<sup>1</sup>

The languages spoken in Peristan (Fussman 1972; Morgenstierne 1974; Edelman 1983; Strand 2001; Bashir 2003; Kreutzmann 2005; Cacopardo A.S. 2013) belong mostly to the Dardic (or North-West-Indo-Aryan) and Nuristani groups, but the linguistic map of the region includes also a non-Indo-European tongue – Burushaski – unconnected to any known language, as well as some peripheral Iranian languages in the north, and, more recently, a major Iranian language, Pashto, which has been expanding from the south since the sixteenth century (Caroe 1958, p. 181), gradually penetrating the mountains. Indeed Peristan was a world in-between. Tucked in between the Iranian, the Indian, and the Turkic worlds surrounding it, for centuries it was reached only by the ripples of the waves raised by the turmoil of the plains, following largely an independent development until the advent of Islam.

If we consider how swiftly the Muslim religion spread in Central-Asian countries, its progress was extremely delayed in Peristan. Though the plains north and south of the Hindu Kush were in Muslim hands already at the end of the first millennium CE, Islam gained its first footholds in the Hindu Kush only in the sixteenth century<sup>2</sup> in an expansionist thrust

---

1 There are significant indications that in earlier centuries this ‘culture area of the mountains’ was even broader, extending to the Western Himalayas (see Cacopardo A.S. 2010a, pp. 350-356, and Zoller 2010, pp. 248-249; Bhat, Wessler, Zoller 2014, pp. 115-121) as well as to the northern slopes of the Hindu Kush (Munphool 1869, p. 132; Wood 1872, pp. 187, 193, 198; Bellew [1891] (1973), p. 143; Robertson [1896] 1974, p. 406; Scarcia 1965, p. CX).

2 Sporadic attacks on the Kafirs are reported from much earlier: Mahmud of Ghazni plundered the Darra-i-Nur valley, in the lower Kunar (Raverty 1880, p. 141) and Timur



Figure 1. The Peristan area

of the Chagatai Khanate that between 1520 and 1550 CE brought armies from Yarkand to establish permanent sub-centres ruled by deputy governors south of the main Hindu Kush chain, seemingly in Chitral and Yasin. The Turks brought with them the Sunni persuasion, but the population remained mostly unconverted. Subsequently, a wave of Shiite refugees entered Chitral from Badakhshan, at the beginning of the seventeenth century. These were Ismailis, whose creed subsequently spread slowly to the east finally reaching Yasin and Hunza between 1792 and 1829.

Laing launched in 1398 CE an expedition against the westernmost valleys of Kafiristan (Masson [1842] 1975, pp. 198-202; Raverty 1880, pp. 135-138, 1896, pp. 69-74; Scarcia 1965, p. CXXXVII). Both conquerors failed to secure a foothold in the mountains.

But though the Ismaili religion was gradually adopted by the rulers of the princely states of the Gilgit basin, the population remained largely pagan, and it was only through the missionary efforts of the Sunni Kashmiri deputy Nathu Shah around the middle of the nineteenth century, that serious attempts were made at strict enforcement of Islamic tenets.

At the southern border of Peristan, after repeated but mostly unsuccessful attempts by the Moghul Emperor Akbar to extend his sway over the mountains at the end of the sixteenth century, the advance of Islam was mainly due to the pressure of the Pashtun tribes immigrated from Afghanistan, who managed to convert the Dardic locals between the end of the eighteenth century and the first half of the nineteenth.<sup>3</sup> The area corresponding to present-day Nuristan, then called Kafiristan by the Muslims, was thus left as the last stronghold of the ancient polytheisms of Peristan, until the crusade waged – with modern weapons provided by the British – by the Afghan Amir Abdur Rahman Khan in 1895 obtained the submission and the (at least formal) conversion of the last independent polytheistic communities, the mysterious ‘Kafirs of the Hindu Kush’, who had stimulated Kipling’s imagination.<sup>4</sup> A tiny shred of the polytheistic world of the Hindu Kush-Karakoram managed however to survive: the Kalasha people of southern Chitral, a population of only a few thousand, whose territory was left by the Durand Agreement of 1893 on the British side of the border, escaped the crusade and still practice their ancient religion to this day in the three small valleys of Bumburet, Rumbur and Birir.<sup>5</sup> Since all the speakers of Indo-European languages have long entered the orbit of one or the other of the great historic religions – Christianity, Buddhism, Zoroastrianism, Hinduism, Islam – the Kalasha represent not only the last remnant of the pre-Islamic cultures of Peristan, but also the last observable example of a ‘tribal’ Indo-European religion.

The complex pre-Islamic world of Peristan raised the interest of British colonial agents, explorers and adventurers from the very beginning, when the area was still largely unknown to Europeans not only in its human, but also in its physical, geography. In the course of the nineteenth century these British envoys collected a wealth of data which are still precious today for anthropologists, linguists and historians.

Professional scholars started finally to investigate the region in the early decades of the twentieth century, but it was only after the Second

---

3 For a detailed reconstruction, with indication of the sources, of the progress of Islam in the Hindu Kush see Cacopardo, Cacopardo 2001, pp. 25-39. Among the most important references are the works of the German historian Wolfgang Holzwarth (1996, 1998, 2006).

4 The reference here is to his famous novel titled *The Man Who Would be King* (1888), about two British adventurers in British India who become kings of Kafiristan.

5 In each valley, however, a varying percentage of the population has converted to Islam.

World War that research in the Hindu Kush really gained momentum. A concerted effort was carried out especially by German-Austrian scholars (van Skyhawk 2008) who studied at length the cultural history of the area, from Gilgit to Nuristan, while individual researchers from different Western countries conducted fieldwork in various parts of Peristan.<sup>6</sup> But though a lot of work has been done over many decades not only in Nuristan and among the Kalasha, but also in Eastern Peristan, by anthropologists, linguists, geographers and historians, only limited – though significant – steps have been made towards a comparative approach aimed at investigating the broader cultural horizons to which Peristan had to be in some way connected, either for distant common origins or, in spite of its historical isolation, for subsequent contacts.

The most immediate horizons of comparison are offered obviously by the Indian and the Iranian worlds; but the analysis could be extended further afield, to pre-Christian Europe and the proto-Indo-Europeans for parallels,<sup>7</sup> or to Central Asia for influences. Here we shall limit our investigation to the cultural worlds with which Peristan was more directly related, i.e. the Indian and the Iranian ones. However, being neither an indologist or an iranologist, I shall only try to offer some materials for future research from the perspective of a scholar of the Hindu Kush, without attempting to reach any solid conclusions. After a perusal of the steps made so far, I shall just try to add some new elements on both sides of the divide.

## 2 Comparative Research in Peristan: the Indian World

The attention of scholars who first embarked on the path of comparison focussed more on the Indian than the Iranian world. This is quite understandable if we consider that Peristan belongs linguistically with India: the Dardic languages are fully Indo-Aryan languages that only a few features keep distinct from the languages of the plains; and also the Nuristani languages, notwithstanding their peculiarities, are in the end closer to the Indian than to the Iranian branch (Buddruss 1973, pp. 38-39). The efforts of these early researchers initially concentrated especially on the pre-Islamic cultures of

<sup>6</sup> A concerted, and long-term, effort was also conducted by Italian scholars, particularly, but not only, in the field of archaeology through the IsMEO (subsequently IsIAO) Archaeological Mission based in Saidu Sharif, in the Swat valley, started by Giuseppe Tucci (Ghaniur-Rahman, Olivieri 2011).

<sup>7</sup> For a first, and limited, attempt in these directions see Cacopardo A.S. 2010a, pp. 357-413. See also Allen (1991) for an analysis of the main gods of the pre-Islamic religions of present-day Nuristan and an investigation of their Indo-Iranian counterparts in the light of a 'quasi-dumézilian' perspective.

present-day Nuristan, as the last polytheistic stronghold of the Hindu Kush on which, in addition to the eye-witness account left by the British colonel George Scott Robertson ([1896] 1974) – who spent a year among the Kafirs in 1890-1891, shortly before their forced conversion – other important data could be collected through interviews with elderly people who still had memory of the pre-Islamic world in which they were raised.<sup>8</sup>

The first steps were made in the field of historical linguistics. The Norwegian linguist Georg Morgenstierne, who did pioneer work in the Hindu Kush starting from 1924, investigated in many works<sup>9</sup> the etymologies of terms that could shed light on the cultural and historical background of the speakers of Nuristani and Dardic languages. His linguistic materials were used by Ralph L. Turner for his monumental work *A Comparative Dictionary of Indo-Aryan Languages* (Turner 1966).<sup>10</sup>

Morgenstierne's work was continued by the German linguist and indologist Georg Buddruss who extended his research to the field of mythology, attempting for the first time this type of comparison. He (Buddruss 1960, 2002) highlighted significant correspondences between Vedic cosmology and the cosmology expressed in the mythology of the Kafirs of the Prasun valley, held to be the religious centre of Kafiristan. He saw a correspondence between the celestial sea of the Vedic Cosmos called *ṛtasya sadana* (the abode of Truth) and the sacred *Sūjem* lake of the people of Prasun, which in their symbolic system represents the Beyond and in its very name recalls the concept of fair law, justice, which in the Vedic system is a concept very close to Truth (Buddruss 2002, p. 131). He found also that one of their main myths showed the imprint of the Vedic theme of the fight between Indra and the primordial monster symbolizing Chaos (Buddruss 1974). In this connection, an important finding made by Buddruss in the field of etymology is that the Prasun word *bem* could be «the only survival known so far, in a modern language, of the Rgvedic meaning of Sanskrit *brahman*-» (Buddruss 1973, p. 42), which did not mean 'the absolute' as in later philosophical speculation, but belonged semantically to the sphere of «religious hymn, poem, prayer» (Buddruss 1973, p. 41). Recently, Buddruss has given

---

8 A written document containing such memories is the autobiography of Shaikh Muhammad Abdullah Khan Azar. The manuscript, bought by Morgenstierne in Chitral in 1929, was published only recently: see Cacopardo A.M., Schmidt 2006.

9 Especially in Morgenstierne 1949, 1951 and 1973 (Fussman 1977, p. 27 fn. 17). For a complete bibliography of his works from 1903 to 1972 compiled at the Indo-Iranian Institute of Oslo University by Knut Kristiansen and Inge Ross see Morgenstierne 1973.

10 Turner's dictionary contains 14,845 'headwords' which have the phonetic structure of the earliest recorded form of the language brought to India by the Indo-Aryans; the reconstructed forms are preceded by an \*. In this article, reference to this work will be made with a 'T-' followed by the number of the relevant 'headword'.

an invaluable contribution to Hindu Kush studies with the complete publication of his collection of Prasun texts (Buddruss, Degener 2015).

After him, the greatest effort was made by the French indologist Gérard Fussman,<sup>11</sup> who argued (1977, pp. 24-25) that the connection to the Indian world was not only linguistic, but cultural as well; Iranian influences preceding the advent of Islam, according to him, are negligible.<sup>12</sup>

In his view even the last stronghold of Kafiristan, the region of present-day Nuristan, the westernmost and most isolated section of our area, did not belong to the Iranian world and – before it was encircled by Islam – was culturally a part of the Indian world, even if only a remote and very marginal one.<sup>13</sup> Through an etymological analysis of the names of gods and spirits he concluded that the most ancient stratum of the Kafir pantheon is Indian (Fussman 1977, pp. 33-34) and therefore comparable to the Vedic pantheon with which, on the basis of linguistic arguments, he highlighted several parallels. Yet, in his view, the roots of the cultures of Kafiristan are pre-Vedic, though post-Iranian: i.e. they date back to a time when the Iranian world had already begun to take form but the spiritual world of the Vedas was still not consolidated. In the centuries that followed, he believes, they developed in isolation without any contact with the Indian world, except through the Dardic domain which, in contrast, is wholly Indo-Aryan, linguistically and culturally (Fussman 1977, p. 35). In a later work Fussman (1983, p. 204) nuanced his position, recognizing that relations between Kafiristan and India had possibly been more complex than he had formerly thought, but he remained convinced that the proposals he had made in his 1977 article, were still valid.

Due to the fascination exerted by the larger and richer cultural context of Kafiristan, only limited attention was at first given by comparative research to the Kalasha, though their culture was the only one still observable of the many that once composed the complex constellation of Peristan. In fact, if in the field of mythology the Kalasha compare quite poorly with the pre-Islamic cultures of the speakers of Nuristani languages, the contribution their culture can give from the point of view of ritual – as we

**11** The possibility of relations with the Indian world had attracted also the attention of Max Klimburg who, in an attempt to interpret the meaning of some wooden images of intertwined couples found in South Nuristan, advanced the hypothesis of a connection between Kafir concepts and Tantric beliefs (Klimburg 1976; 1999, pp. 138, 313), a proposal already fleetingly aired by Edelberg (1960, p. 282).

**12** He (Fussman 1977, p. 25 fn. 14) quotes the Nuristani Kati term *nəmōč*, ‘prayer’ as a rare instance of an ancient borrowing from Iranian.

**13** A view shared also by Morgenstierne (1947, p. 240). Some connection to the cultural universe of India appears indeed to have been perceived to some extent also by the population, because several early sources (Mohan Lal [1846] 1971, p. 342; Gardner [1869] 1977, p. 50; Goes in Wessels [1924] 1997, p. 15) relate that Hindu merchants were usually admitted, and well received, even in the heartlands of Kafiristan, where no Muslim had access.



shall see – has been unjustly overlooked. Only more recently has Kalasha material been taken into proper consideration by the German-American indologist Michael Witzel (2004) in an extensive study dedicated to the antecedents of the Rgvedic religious system.

Witzel refers in his comparison both to the pre-Islamic Nuristani and Kalasha religions, always specifying the position of each. Also, he analyzes the pre-Islamic religion(s) of the Hindu Kush as a system, considering not only the mythology, but also rituals and festivals. His conclusion is that «In sum, the Hindu Kush area shares many of the traits of Indo-Iranian myths, ritual, society, and echoes many aspects of Rgvedic, but hardly of post-Rgvedic religion» (Witzel 2004, p. 614). His endeavour ventures far back into the Indo-Iranian world – and beyond that, into the proto-Indo-European and even Eurasian universes – but the scope of his research prompts him to investigate more in depth the Indian than the Iranian side. The traits he enucleates as Rgvedic antecedents include the existence of a creator god like Imra whose name is connected – as Fussman (1977, p. 30), and Morgenstierne before him (1951, p. 163), had already pointed out – to Sanskrit Yama Raja; the preponderance in myth and ritual of the typically South-Asian number 7 in contrast to the Northern Eurasian 9; and, more importantly, the presence of an «Indra-like figure» appearing in various forms and under various names (Witzel 2004, pp. 606-607). Apart from the field of mythology, his contribution is particularly significant for what concerns ritual and festivals: in his view, ritual in Hindu Kush religion is still of the Indo-Iranian type but South-Asian and Vedic influences are remarkable. Among other features, he notes the exogamic rule mirroring the Vedic one, the importance of the concept of purity, as in India, which affects the status of women and prompts the exclusion from ritual of a group of artisan/serfs who form a caste of untouchables, like the Vedic Sudras; and he draws an interesting parallel between the role of virgin boys as semi-priests – they are the ones who materially perform rites – and that of the Brahmacharins of the Atharva Veda.

### **3 Comparative Research in Peristan: the Iranian World**

If parallels with the Indian world were sought somewhat selectively and just by a few scholars, Iranian connections were mostly only suggested (Tucci 1963, p. 158; Scarcia 1965, pp. CXVII, CLIV; Gnoli 1980, p. 70) and never came under systematic investigation. Wolfgang Lentz went just a step further by arguing in a brief note presented at the first Hindu Kush Cultural Conference held in Moesgård in 1970 that a number of mythological traits about the deeds of Imra, the supreme deity of the Kafir pantheon, have parallels in some features of the legend of Mithras (Lentz 1974, p. 37).

Only Jettmar, however, broached the issue in some detail (Jett-

mar 1974; 1986, pp. 135-137). In his contribution to that same conference, he gave some examples of what seemed to him «parallels between Iranian and Dardic institutions and ideas» that, in his view, were «not due to a common heritage going back into Indo-Iranian antiquity but to diffusion in the course of a long and complicated symbiosis» (Jettmar 1974, p. 40). But it is in the 1986 English edition (Jettmar 1986) of the volume of his *Die Religionen des Hindukusch* (Jettmar 1975) dedicated to the religion of the Kafirs – as the title reads – that he deals at length with the issue in relation to the pre-Islamic religions of the region of present-day Nuristan which, occupying the westernmost section of the Hindu Kush, was the area more exposed to possible Iranian influences. His point of departure is an analysis of the position of Imra in which he discusses some arguments put forward by Fussman (1977).

Fussman had noted, as mentioned, that Imra's name can etymologically be derived from that of the ancient Indo-Iranian divinity Yama. Since among Imra's names there is Mara 'the killer', which is also the name of the god of the Underworld, he (Fussman 1977, p. 49) had argued that the Kafir god had the same double position as that held by Yama who, in Vedic and Iranian texts, appears both as the King of Paradise and as the Lord of the Underworld. For him this contradiction was due to the existence among the ancient Indian populations of two distinct systems of beliefs, one centred around Indra and Brahma, the other one around Mara, who, in Mauryan times, became, as god of the heathens, the arch-enemy of the Buddha (Fussman 1977, pp. 50-51). In Fussman's view there are enough elements to assert that this twofold system dates back to Indo-Iranian times and he suggests that the presence of these two hierarchies must have something to do with the struggle between *Asura* and *Deva* and their inverted positions in the Indian and Iranian systems (Fussman 1977, pp. 58-59). Jettmar challenges this conclusion – which, he remarks (1986, pp. 53, 133), was also supported by Buddruss – arguing that, before the advent of Islam, «during the 'historical' period...in the times when states known to us by name existed outside the mountain region» (p. 137), Kafiristan was not as isolated from the world of the plains as Fussman believed, and as was actually the case after the permanent establishment of Islamic states. He notes in this connection that the Imra religion was not indeed equally rooted among the speakers of Nuristani languages, and that its diffusion is to all appearances due to the dominant position acquired in pre-Islamic times by the Kati speakers (pp. 133-134)<sup>14</sup>. From here he goes on to observe that the Kati were settled in the extreme western portion of

14 This is confirmed by Klimburg (1999, p. 142) who reports that in the southern Nuristani valleys of Waigal-Ashkun, Imra, though quite popular, «was considered a deity of Bashgal, Kantiwo and Prasun». For Klimburg his place in southern Kafiristan was due to «the influence of the religious beliefs among the Kati Kafirs» (1999, p. 142). It seems also significant

the region, and therefore came in contact with Iranian populations who worshipped Yima (the Iranian equivalent of Yama) who «had many attributes which would predispose him to take the place of Imra» (p. 53). To their influence – as well as to «a negative reaction to Buddhist preponderance in the surrounding lowlands» (p. 135, cf. pp. 52-53)<sup>15</sup> – is possibly due in his view, the final promotion of Imra/Mara to supreme creator god, if maybe not the outright introduction of his cult. In sum, rather than focussing on ancient Indo-Iranian roots, and without denying that there might have been «various conceptions of the pantheon» (p. 135), he brings to the fore more recent Iranian influences.

Though Jettmar's idea of a «negative reaction to Buddhist preponderance» seems quite conjectural, and even doubtful (cf. Klimburg 1999, p. 355), his focus on Iranian influences does not seem out of place. It may be interesting under this regard – and without opposing the fascinating idea of the existence of two distinct systems of belief among the ancient Indian population – to elaborate on his proposal by highlighting the differences between the figure of Imra/Mara and that of Dizala Dizaw, the Supreme God of the Kalasha pantheon. Dizaw is a typical *deus otiosus* (Eliade 1976, pp. 51-56; Brelich 2007, pp. 32-37) who, after completing the task of creation, entered a state of permanent inactivity abstaining from any interference with human affairs (Morgenstierne 1973, p. 155).<sup>16</sup> His cult is consequently reduced to some rare ritual offerings and, in contrast to what is the case for the other divinities, there is no holy place or altar dedicated in his name. If we were to resume a distinction made by Raffaele Pettazzoni (1957, p. 91) – the prominent Italian historian of religions – more than half a century ago, between a type of Supreme Being characterized by omniscience and another characterized by creative power, Dizala Dizaw would belong to the latter. He has to do with the world and its origins, and not with human beings and their behaviour; he guarantees the permanency of creation, but he does not control and does not sanction human actions. Imra/Mara, in contrast, would definitely belong to the former type. He was sacrificed to very frequently, his temples were found in every village (Robertson [1896] 1974, pp. 388-389), and in myths and stories he interacts with humans and gods behaving at times with cunning, arrogance or even deceit (pp. 385-389; Jettmar 1986, p. 48), very much as a human

here, as Jettmar notes, that a secret 'language of the gods', used for cultic purposes, «turned out to be an archaic form of Kati» (Jettmar 1986, p. 134, cf. p. 33).

15 On this point see also Klimburg 1999, p. 355

16 The etymology of his name – from the root *D'iz* connected to old Indo-Aryan *dehati* 'makes, builds' (T-14621) – does not qualify him as a divinity connected to the celestial sphere like the main gods of many Indo-European pantheons, who are generally designated by names derived from the Indo-European root *\*deiwos*, 'luminous', 'celestial'; but lack of cult and absence from the annual ritual cycle usually characterize celestial gods (Eliade [1948] 1976, p. 51).

being might do. Yet, he is also the creator god whose place is in the sky, and he is depicted as «law-giver of the world» and as «cultural hero» who brought to men important innovations, such as the plough or the first mill; and it is said of him that after teaching humans he withdrew to his abode in heaven «never to be seen again» (Jettmar 1986, p. 49).

Peter Snoy, a prominent member of the German Hindu Kush research team, believed that Imra's role as a creator god had been exaggerated by the early Christian explorers and the Muslims who first came in contact with the Kafirs, but the comparison with Dizala Dizaw seems to indicate that that might in fact have been his original role. Indeed his figure includes the main traits of the Kalasha Supreme Being: a creator god whose seat is in the sky who, after creation, retires to a distant abode leaving human affairs to lesser deities; he is also connected to luminosity<sup>17</sup> and has therefore all the basic characteristics of an archaic sky god (Eliade [1948] 1976, pp. 61-65) who had become a *deus otiosus*. The coexistence of the two types of Supreme Being, especially in one and the same divine figure, is not so common because the two figures stem from different experiences and different needs (Brelich 2007, p. 37): the immobility of the *deus otiosus* has the function of maintaining unchanged, and of guaranteeing, the order he established once and for all (Pettazzoni 1957, pp. 90-91), while the active type of Supreme Being satisfies the need for permanent effectiveness in relation to human affairs; the former has to do with the origins, i.e. the past, the latter with the present, of a community. We may wonder whether in the case of Imra/Mara a transformation had taken place from a *deus otiosus* to an active divinity, a figure deemed on the other hand more typical of polytheistic systems (Brelich 2007, p. 33).<sup>18</sup> For the Kalasha a similar process has been witnessed in recent times: increasing contacts with the Muslims especially in the course of the last century has brought them, by now, to identify almost completely Dizaw with the God of the Muslims, to the point that his traditional name is rarely used;<sup>19</sup> he has become therefore a very active god. It is possible that a similar transformation concerned Imra in earlier times. If this is so, it is not inconceivable that it took place – as Jettmar supposes – among the western Kati under the influ-

17 In a Kati hymn he is surrounded by a golden aura (Morgenstierne 1951, p. 163).

18 The fact that the name Imra can be derived from Yama, who does not have the traits of a *deus otiosus*, does not seem of hindrance to this hypothesis: the etymological connection is likely to go back to a time well before the Vedas, when the figure of Yama could possibly have had different characteristics. It seems quite possible at any rate that, through the play of historical circumstances, etymologically related names end up designating different divine figures.

19 For the text of a prayer in which the name of Allah occurs see Cacopardo A.S. 2010b, p. 230. The name he is most commonly addressed with, however, is Khodây, a Persian term largely used by the Muslims of the surrounding areas.

ence of the nearby east Iranian world. Though we are here in the slippery field of conjecture, we could add to his hypothesis by suggesting that, if not by the cult of Yima, the transformation could have been triggered by the figure of the omniscient, all-powerful and very active supreme deity which arose in that area from the predication of Zoroaster.

Be that as it may, Jettmar's overall idea that influences from the civilizations of the plains, before the advent of Islam, did reach the mountains, seems reasonable. It is perhaps only in this light that the highly specialized craftsmanship of the artisan class can be explained, as well as the presence – as Jettmar (1986, pp. 136-137) points out – of technological achievements like metallurgy that produced refined items such as the famous silver cups,<sup>20</sup> or the sophisticated irrigation techniques, the high-quality wood-working skill, and the horizontal water mill. Indeed traits such as these are typical of those socio-cultural universes which used to be called 'civilizations' – meaning by this term societies that knew writing, the State, money, social stratification, metallurgy etc. – as opposed to 'primitive cultures', characterized by stateless political organizations, social structures based on kinship, merit feasts, and the presence of shamans. Even polytheism itself, in fact, according to some prominent historians of religions (Sabatucci 1998, pp. 16-19; Brelich 2007, pp. 31, 115-117), is found typically in complex societies that know writing – such as those of Mesopotamia, Egypt, Greece, Rome, pre-Christian Northern Europe, pre-Columbian Mexico, etc. – rather than in the so-called 'primitive' societies, where it is absolutely exceptional. The pre-Islamic world of Peristan is a rare example of the merging of traits belonging to both models: under this respect as well, it was a world in-between. Considering that the plains surrounding the Hindu Kush saw the rise and fall of some of the greatest civilizations of the old world, this may not be so surprising: their influences, faint as they may have been, in the course of the centuries must have reached the mountains. That some of these influences should have come from the Iranian world, especially for what concerns the western part of Peristan, seems only logical. But to detect them with accuracy is a task that only a specialist in Iranian studies can carry out in full.

For our part, we shall now try to facilitate the work of Iranian specialists and indologists by providing an inventory of the Indian and Iranian traits we have been able to detect in the traditional symbolic system of the Kalasha on the basis of data collected during fieldwork we conducted on ritual texts and practices. Since in its basic core, the Kalasha system can be considered quite representative of the pre-Islamic world of the Hindu Kush – multifari-

---

20 First mentioned by Elphinstone ([1815] 1969, p. 626), they were seen for the first time by a European researcher over a century later (Edelberg 1965).

ous as that was - we trust our research will provide some useful hints for specialized scholars. We shall first consider the Indian elements in Kalasha culture, which are more evident and easier to enucleate, and we will proceed subsequently to the investigation of the more elusive Iranian traits.

#### 4 Kalasha Religion. A Comparative Approach: Indian Traits

If we look at the Indian universe, the most manifest connections in the Kalasha system are with the Vedic world.

The names of several divinities are etymologically connected to those of the Vedic pantheon, and especially to Indra. This is the case of the two main gods of the Birir valley, Warin and Praba, whose names, for Ralph Turner (1966), can be derived respectively from *\*aparendra* (unrivalled Indra) (T-444), and *prabavhra*, one of the names of Indra (T-8782). The very name Indra has also been preserved in that of the god Balimain (*bal'ima-in* most powerful Indra<sup>21</sup>) - the deity believed to visit the Kalasha valleys on the night of the winter solstice - who is often invoked in ritual as Indr (Wutt 1983, pp. 123, 132; Loude, Lièvre 1984, p. 261). Indeed he presents many traits of the Vedic Indra: as did originally Indra (Stutley, Stutley 1980, p. 170), he personifies the power of generation and fertility; and just as Indra is considered in Indian epic literature the founder of the New Year celebration (Dumézil 1929, pp. 11, 122-124), so is Balima-In seen as the re-founder of the Chaumos winter solstice festival in one version of Kalasha mythology (Jettmar 1975, pp. 354-355; Snoy 2008, pp. 50-64; Cacopardo A.S. 2008, pp. 102-104, 2010a, pp. 300-302) in which he is said to have taught the new rules of separation and to have instructed the people about the rituals to be performed. Interestingly, another Vedic divinity is associated with Balima-In: the servant of the god is called Pushaw (*p'ushaw*), a name we can easily connect to the Vedic Pushan, a god in his turn associated with fertility and the sun (Stutley, Stutley 1980, p. 350) who, in a Vedic hymn (RV, VII, 35, I), is merged with Indra in a dual divinity, Indra-Pushan (Stutley, Stutley 1980, p. 174). Other Vedic connections indicated by Turner concern the goddess Jeshtak, who presides over family relations and rites of passage, whose name may be derived from that of the Rgvedic goddess *dēSTrī* (T-6556) or, possibly from *jyeSTha*, the first, the elder (T-5286); the *JaC* spirit(s) connected to agriculture whose name is etymologically related to the Sanskrit *yaksha*, a term designating spirits venerated since pre-Vedic times who were possibly vegetation dei-

21 *bal'ima* is an epithet borrowed from Kati, the geographically closest Nuristani language, meaning 'most powerful' and used in hymns as an attribute of gods (cf. Morgenstierne 1951, pp. 180, 184; Jettmar 1975, p. 358), *in* stands for Indr. This is in my view the most likely etymology. Informants gave no explanation of the meaning of the god's name.

ties of rural communities (Stutley, Stutley 1980, p. 502; T-10395; cf. Morgenstierne 1973, p. 156); the name of the *s'uci* mountain spirits derivable from *sucikā*, one of the Apsaras (T-12510) or from \**suvatsika*, a goddess (T-13514); as well as, last but not least, the two terms designating the gods: *d'ewa*, manifestly connected to Sanskrit *deva*- (T-6523), and *dewal'ok* derived from *devaloka*, the abode of the gods (T-6539).

Equally important connections can be found in the field of ritual. From Sanskrit is derived the name of the main event of the whole Kalasha ritual cycle, the Chaumos (*caum'os*) winter solstice festival. The connection is with the *cāturmāsya* (T-4742) festivals which, in Vedic times, were celebrated every four months in spring, in summer during the rainy season, and in autumn (Sergent 2005, p. 388). In fact the Kalasha ritual cycle itself appears to correspond quite closely to the Vedic one because it is subdivided in three great ritual sequences taking place in spring when the transhumance of the herds starts, in late summer when the fruits of pastoral and agricultural activities are collected, and in winter when their consumption begins and the regeneration of the world is celebrated (Cacopardo A.S. 2010a, pp. 111-121). Obviously, due to the climatic differences, the position of the three Vedic festivities in the year cycle does not coincide exactly with the Kalasha pattern, but the etymology of the name Chaumos seems enough to confirm that the connection exists. A further interesting correspondence in the field of ritual, is that of the term *diC*<sup>22</sup> designating the holiest period of the winter solstice festival when, to restore a state of purity, separation of genders is enforced, the men retire to the goat-sheds, and all outsiders are ousted from the villages. *diC* is related to the Sanskrit term *diksha*, designating the elaborate preparations of the great Soma sacrifice (Dumont, Pocock 1959, p. 16). *diksha* is associated with the concept of rebirth, attained through sacrifice, and it has the meaning of 'initiation', 'dedication', 'consecration' (Stutley, Stutley 1980, pp. 114-115; see also Kuiper 1970, p. 117). Though the context is not the same, the Kalasha term appears to cover the same semantic field, a period of preparation in the wake of a ritual event consisting in a rebirth: of the novices initiated during the festival, and of the community at large that celebrates its own rebirth with the rituals of the New Year.

At the social level, an important trait connecting not only the Kalasha but the whole of Peristan to the Indian world is the exogamic rule - already present in the Veda (Witzel 2004, p. 615) - forbidding marriage between two people who had a common ancestor in the male line up to the seventh ascending generation, which governs the formation and the evolution of the patrilineal lineages. Lineage exogamy is indeed widespread in

---

22 In our transcription of Kalasha words, capital letters indicate a retroflex articulation.



India, and it is codified in the *sapinda* system, which is based essentially on the same rule (Karve 1953 in Berreman 1972, p. 158; Nicholas 1981, pp. 371, 377; Goody 1990, p. 157).

If, finally, we consider the Indian system as a whole, the most significant affinity with the pre-Islamic cultures of the Hindu Kush is maybe the central role played at the symbolic level by the pure-impure polarity. The opposition has been developed in Hinduism in a very complex system that is obviously very different from the Kalasha and the Peristani ones in general: a system reflecting a highly stratified society which new writing, the State, and money, and had a class of priests and sacred texts. But an analysis of the articulation of the polarity in the two systems indicates that those very different developments are the fruit of opposed applications of one and the same principle. A comparison between the Indian caste system and the Kalasha system has been recently carried out by Alberto M. Cacopardo (2009, pp. 163-169)<sup>23</sup> on the basis of the famous work by Louis Dumont, *Homo hierarchicus* (1979). The central thesis of Dumont's book is that the dichotomy pure/impure encloses the hierarchical principle which, with those of separation and interdependence it subsumes, represents the fundamental principle of Hindu society:

Cette opposition sous-tend la hierarchie, qui est superiorité du pur sur l'impur, elle sous-tend la separation parce qu'il faut tenir séparé le pur de l'impur, elle sous-tend la division du travail parce que les occupations pures et impures doivent de même être tenues séparées. (Dumont 1979, p. 65)

Alberto M. Cacopardo argues that the same conceptual tools have been used, in the two cases, for radically diverging ends, because in India they generated the highly stratified caste system, while among the Kalasha they were put at the foundation of an essentially egalitarian system. The principles of hierarchy, separation and division of labour in the case of the Kalasha – he observes – have been used to found the distinction between genders, instead of that between castes<sup>24</sup>. The opposition '*onjiSta-pr'agata* (pure-impure): a) puts the male gender in a condition of ritual superiority; b) founds the separation between genders by denying access to the goat-sheds to women and by segregating them in the *bas'ali* house during menstruation and parturition; c) establishes the division of labour between genders on the basis of the relative purity of their respective occupations. The result is the exact opposite of what happened in India because, by

<sup>23</sup> Alberto M. Cacopardo is brother of the author and director of the various research projects the two researchers conducted in Chitral under the aegis of the Istituto Italiano per l'Africa e l'Oriente (IsIAO, ex-IsMEO).

<sup>24</sup> A similar remark was made also by Jettmar in his main work on the religions of the Hindu Kush (1975, p. 464).

confining the distinction pure-impure to the sole field of gender relations, the effects of the hierarchical principle are limited to that sphere and the principle of equality is conversely, and consequently, affirmed within the genders. Even if in the disparity between men and women, the hierarchical principle is therefore rejected as a principle of social organization. The fact that, in spite of this fundamental difference, the two systems are based on a common core of symbols is indicated, Alberto Cacopardo also observes, by the circumstance that, in both of them, the prescriptions concerning purity have to do with the organic aspects of human life, which for Dumont (1979, p. 70) are the immediate source of the notion of impurity. Indeed among the Kalasha, as is the case in India (Harper 1964, pp. 158-169; Dumont 1979, pp. 72-73; Nicholas 1981; Levy 1990, pp. 388, 455), impurity is connected to menstruation and childbirth, as well as to death: women are segregated in the focal moments of their reproductive activity, and, as in India (Dumont 1979, p. 74), the relatives of the deceased are temporarily impure and they do not shave for the whole period of mourning. Further, Alberto Cacopardo notes, just like commensality is forbidden between untouchables and the 'twice-born', so are Kalasha women forbidden to eat from the same plate as men and they do not touch with their lips the drinking vessels used by males. The opposed application of the pure-impure polarity made by Brahmanic India has evidently much to do with power, because the ritual hierarchy replicates in the symbolic sphere the hierarchy established at the economic and political levels, founding the alliance and the complicity between kings and priests on which is based, as Dumont argues, the whole history of India (Cacopardo A.M. 2009, pp. 165-166).

If Kalasha society and the known Peristani systems in general<sup>25</sup> tend to reject hierarchy as the founding principle of social organization, they do not totally expel it from their horizon - we may add - because the pure-impure dichotomy, apart from founding the ritual subordination of women, founds also a division known throughout Peristan between free-men and artisan-serfs. If among the Kalasha these were serfs, among the speakers of Nuristani languages, in pre-Islamic times, the members of this group were mostly true artisans (*bar'i*)<sup>26</sup> specialized, as mentioned earlier, in advanced techniques which included wood-carving, metallurgy, and ceramics. This subordinate minority was undoubtedly a caste: they formed an endogamous group, deemed inferior, connected to specific occupations; physical contact with its members could contaminate free men, and commensality was therefore forbidden; finally, it was an unchangeable status

---

25 An exception is reportedly (comment by Max Klimburg) represented by the pre-Islamic society of the Parun valley, in Nuristan.

26 A lower class of serfs, called *shūwala* also existed (see e.g. Klimburg 1999, pp. 69-70).

acquired by birth.<sup>27</sup> Furthermore, at variance with what is usually the case in class societies, where the groups of higher status are also the less numerous, here we have a vast majority of free men and only a small minority of serfs (Robertson [1896] 1974, p. 102; Duprée 1971, p. 8; Jones 1974, p. 95; Klimburg 1999 p. 62), an inversion that, according to Leach (1969, p. 4), is typical of caste societies. The pure-impure polarity did therefore lead in Peristan as well to the emergence of the notion of caste but, nevertheless, Alberto M. Cacopardo again argues, the principle of hierarchy was not developed in the mountains in the same direction as in the plains: in spite of the presence of this caste of untouchables, Kalasha society and the other known pre-Islamic societies of Peristan in general, remain fundamentally egalitarian because the principle of hierarchy – outside the sphere of gender relations – had only a very limited application. For certain, we are not dealing with caste systems. The presence of a small caste of untouchables is not enough to qualify them as such: as observed by Dumont, a society may be so qualified only if in its whole it is divided in a series of castes; which is definitely not the case for the Kalasha and for the other societies of Peristan (Cacopardo A.M. 2009, p. 169).<sup>28</sup>

From what remarked so far it appears that the Indian traits in Kalasha culture are due to common origins rather than to subsequent historical contacts. We do find nevertheless some stray traits indicating more recent Hindu influences. Of these the most prominent is the name of the god Mahandeo, which was a honorary title first of Vishnu and then of Shiva (Stutley, Stutley 1980, p. 249; Gonda in Jettmar 1986, p. 60), a divinity whose connection to our area, according to Tucci (1963, p. 160), is quite certain. Traces of more recent Hindu influences have been found also among neighbours of the Kalasha (Cacopardo, Cacopardo 2001, p. 160) and even in Kafiristan-Nuristan where we find the seven Paneu brothers (Jettmar 1986, pp. 75-76) that for Morgenstierne (1951, pp. 165, 174-175) are etymologically connected to the Pandava brothers of the Mahabharata,<sup>29</sup> or the Kamdesh god Arom who's name, according to Strand (2001, p. 220 fn. 390), is probably derived from Rama. Quite predictably, more Hindu

27 We are referring here to the definition of caste given by Hutton (in Leach 1969, pp. 2-3).

28 Pace Fussman who in his 1977 article extended his comparative effort beyond the pantheon to the social structure suggesting that, among the speakers of Nuristani languages, pre-Islamic society was divided in groups strongly reminiscent of the four original Indian castes (the *varna*); data subsequently acquired showed instead that ancient Kafiristan was not a society based on castes (Klimburg 1999, pp. 62, 346-348; Cacopardo, Cacopardo 2001, pp. 43-44).

29 Some doubts are however expressed by Fussman (1977, p. 34) from the semantic point of view, though he recognizes that phonetically the etymology is perfectly viable.

influences are to be found in Eastern Peristan among the Shina speakers,<sup>30</sup> the alimentary prohibition of beef (cf. Göhlen 1997, p. 165; Cacopardo, Cacopardo 2001, p. 137) being the most conspicuous example. In spite of geographical isolation, some contacts with the Hindu world must indeed have occurred before Peristan became encircled by Islam, and even after that. Ruins of a temple of the Hindu Shahi period, from the eighth or ninth century, were found as far west as the Kunar valley immediately to the south of Chitral (Lohuizen-de Leeuw 1959), and we know that still in the nineteenth century a sacred spring in Bajaur, just south of our area, formed a pond that once a year attracted many Hindus from the surrounding areas for a ritual bath (Raverty [1880] 1976, p. 183).<sup>31</sup>

Such traits however are few. It seems quite clear that the affinities and connections linking the Kalasha and Peristan to the Indian world point much more to the old Indic world than to Brahminical India. Fussman, apparently, was not mistaken when he stated that

les religions des pays de langues kafires sûrement, et de langues dardes probablement, étaient des religions indo-ariennes, mais des religions qui n'auraient pas connu l'élaboration théologique brahmanique. (Fussman 1976, p. 205; cf. 1977, p. 25)

In fact, already the world of the Vedas, as noted earlier, appears to reflect a society that had undergone developments unknown in Peristan: it was a stratified society, with a nobility and a class of priests who had knowledge of writing. If we consider the Kalasha pantheon, the circumstance may be indicative that we find there the figure of a Creator god like Dizala Dizaw, a *deus otiosus* who recalls Dyaus Pitar,<sup>32</sup> the archaic sky-god of the ancient Indo-Aryans (Sergent 2005, p. 348), whose memory only faintly survives

30 Here, in Gilgit, was stationed as British Political Agent Major John Biddulph who, in an influential work, argued in favour of strong Indian influences on the region before the advent of Islam: he believed that Buddhism had been the religion of the area before it was superseded by forms of Hinduism brought by the Shina, whom he saw as immigrants from the south (Biddulph [1880] (1986), pp. 109-115). Subsequently, Jettmar came however to the conclusion that the pre-Islamic religion of the Shina was «very distant from the essential beliefs of Hinduism» (Jettmar 1975, p. 291) and, though Hindu influences may have been more evident among them, it is quite clear now that the pre-Islamic culture of the Shina-speakers was of the Peristani type: see Jettmar 1975, pp. 215-220, and Cacopardo, Cacopardo 2001, pp. 27-28.

31 Morgenstierne (1944, p. VII) even thought that the pre-Islamic religion of the Pashai of Afghanistan, speakers of a Dardic language in the south-westernmost portion of Peristan, might have been a form of Hindu-Buddhism; but his idea has been proved to be unfounded (see Cacopardo, Cacopardo 2001, pp. 37-38).

32 The two names, however, are not etymologically connected because one derives, as we have seen, from the root *Diz*, to make, build, while the other comes from the Indo-European radical *deiwo-*, sky (Eliade [1975] 1979, p. 209).

in the Vedic texts (Eliade [1975] 1979, pp. 219-220). If Kalasha religion undoubtedly echoes many aspects of the Rgvedic religion (and very little of post-Rgvedic), its roots appear to be even older than that, for they hark back to an Indo-Aryan past preceding the emergence of the Vedas. As we have seen Fussman concludes (though with some caution for the Dardic domain), this may be said of the pre-Islamic religions of the Hindu Kush in general. Many elements seem therefore to indicate that the cultures of Peristan were unique examples of Indo-Aryan cultures that, left aside by mainstream Hinduism, followed largely an independent development. But while for Fussman they belong to a post-Iranian, though pre-Vedic, phase, for Witzel, as mentioned, their roots may go further back, to the undivided Indo-Iranian past. A glance at the Iranian side will help us to see whether our data give any support to this hypothesis.

## 5 Kalasha Religion. A Comparative Approach: Iranian Traits

If we turn to the Iranian side of the comparison the new elements we can offer on the basis of our study of Kalasha ritual are much fewer. They amount just to two, but we believe they deserve some attention.

The first one consists in the name of a divinity invoked in a hymn, sung by women in a chorus, during the most sacred days of the Chaumos winter solstice festival. The texts of this type of chants can be very old because, since they are always sung in a chorus, the lyrics are common knowledge and tend therefore to be deeply embedded in collective memory. In this case, the archaic character of the text is indicated by the name of the divinity invoked: Bidrakalen (*bidrakal'en*). A god with this name does not appear in any other context. There is no myth, story, or prayer, in which such a name is mentioned. To our questions people (in Birir, where the text of the chant was recorded)<sup>33</sup> only answered that Bidrakalen is the god who descends in the Kalasha valleys for the Chaumos festival. Etymologically, it seems, the name may be linked to Vṛtra, the Vedic monster obstructing creation. A plausible hypothesis in this direction could be *b'idra-kal-en*, where the second element would be a temporal reference (*k'aw/k'aluna*, in the Kalasha language 'year', 'in the year') and the third would be a locative.<sup>34</sup> The semantic result would be 'in the time of Vrtra', i.e. the time of the beginning, and the name would then mean 'the god of the times of the beginning'. In alternative – perhaps an even more fascinating hypoth-

<sup>33</sup> For the transcription of the text of this hymn, recorded by the author in the Birir valley in 2006, see Cacopardo A.S. 2008, pp. 88-90.

<sup>34</sup> A proposal for which I must thank Pierpaolo Di Carlo, the linguist in our team, who has studied at length Kalasha ritual texts.

esis – we could think of a derivation from *Vrtraghan* or *Vrtrahan*, ‘killer of Vrtra’, an epithet of Indra which, for Witzel (2004, pp. 599, 601), goes back to Indo-Iranian times (cf. Sergent 1997, p. 293): a solution consistent with various ritual elements which indicate, as we have seen, that the god of Chaumos is none other than Indra. Both hypothesis, at any rate, are quite consistent with the context: a reference to the time of Vrtra when initiations are about to be celebrated and the community is preparing for a new beginning, is certainly appropriate; and even more appropriate would be a reference to the ‘killer of Vrtra’, i.e. Indra. In this latter case, the connection to the Indo-Iranian world (if confirmed) would be of special historical interest, for it could give support to Witzel’s (2004, p. 614) idea that the pre-Islamic world of the Hindu Kush brings us back, not only to a pre-Vedic Indo-Aryan past, but to the still undivided Indo-Iranian world.

The second new element we can present concerns a specific ritual which had never been documented before. This is the celebration of the New Year in the Kalasha valley of Birir. The ritual is part of the winter ritual sequence, which is the longest and more complex of the three composing the Kalasha ritual year. Starting at the beginning of December, it culminates in the Chaumos winter solstice festival to continue, at intervals of days or weeks, until the end of February (Cacopardo A.S. 2008, 2010a, 2010b). When in 2006-2007 we followed the whole sequence we found out with some surprise that the beginning of the new year did not coincide with the winter solstice, though this was grandly celebrated for seven days in a row. It was a distinct, and quite separate, ritual event, called *salgher’ek* which, in 2007, took place on 31 January and 1 February. The time of the celebration, we were told, coincides with the full moon of the lunar month following that of the solstice.<sup>35</sup> A beginning of the year in February is not something unusual. Quite appropriately Dumézil (1929, pp. 6-10) remarked long ago that the winter period, with the pause (in temperate climates) in agricultural activities, though typically a time of intense social life, does not offer, for religious celebrations, those fixed points of reference that are provided in the other seasons by the rhythm of work in the fields. Lacking a direct connection with productive activities, ritual events, comparatively considered, show «incertitude de date» (p. 6) and tend to fluctuate under the influence of historical circumstances. In the Indo-European world, however, Dumézil notes, New Year celebrations are always included in the two thresholds of winter, that is between December and March.

If a New Year celebration in February is hence nothing exceptional, we may still wonder, however, why in Birir it does not coincide with the

---

<sup>35</sup> In fact in 2007 *salgher’ek* was held a couple of days before the full moon, probably because the exact time of ritual events – as reported by Parkes (quoted just below, in the text) – is determined not by the phases of the moon, but by the observation of the place where the sun sets on the mountain crests closing the valleys to the west.

winter solstice, especially since this is celebrated with a festival of the grandeur of Chaumos. The logic may be that the end of a cycle must be kept separate from the beginning of the new one, for beginning and end, though connected, are not the same thing. Therefore, a period of margin (Van Gennep [1909] 1981, p. 157), a crepuscular phase, is inserted between the two events.

Even if celebrated still in winter, *salgher'ek* appears to be a spring celebration. This can be inferred from the name of the main ritual – *b'asun don*, 'spring bullock' – and from the fact that it is placed right at the end of the coldest period. A spring-time new year, as opposed to a winter-time one, was a tendency prevailing in the Iranian world, whose influence appears to be indicated also by the very name of the ritual event: if *gher'ek* is a Kalasha term, *sāl* is the Persian word for 'year' which is never used by the Kalasha in everyday speech. Possible Iranian influences, however, do not appear to be related to the official Iranian New Year (*No-ruz*, *Norouz*, *Nawroz*), hailed on 21 March, which, already celebrated by the Achaemenians (Eliade [1975] 1979, pp. 346-348) and promoted to national holiday under the Arsacids, is in its roots a ritual of royalty (Gnoli 1980, pp. 196-197, 217) that has little to do with the world of the Kalasha. We should rather look at the festival called *sada*, celebrated in many places on the 10th of the month of Bahman, a date that corresponds to 30 January and coincides, therefore, almost exactly, with the date of *salgher'ek*. The Iranian *sada* is an ancient pastoral festival (Cristoforetti 2003), including themes possibly even of pre-Zoroastrian origin. Though not considered as such, it has the traits of a New Year ritual complex, in which bonfires are lit and the end of the coldest time of the year is celebrated. We have here a further lexical correspondence: in Iran *sada* marks the end of *čilla-yi buzurg*, great *čilla*, and the beginning of *čilla-yi kūčak*, little *čilla* (Cristoforetti 2003, p. 75). In the same way the Birir celebration takes place at the end of the period called *gh'ona cil'a*. The first word is the Kalasha term for 'big' 'great', while the second one – which was interpreted by informants as meaning 'cold' – is quite manifestly the Persian *čilla*, meaning 'the forty days', which was used to subdivide the Iranian sequence of winter pastoral feasts (Cristoforetti 2003, p. 75). It seems quite significant, therefore, that between the end of Chaumos and *salgher'ek* there is an interval of just about forty days.

Such a surprising correspondence may be taken as an indication of further parallelisms between the winter feasts of the Kalasha and the ancient Iranian pastoral winter cycle, which would be indeed an exciting discovery. In no other instance, however, do we find mention among the Kalasha of the term *cil'a*, nor have we heard any reference to subdivisions of time in periods of forty days in winter or, for that matter, in the rest of the year. The Kalasha have a lunar-solar calendar that divides the year in 12 months – for which the same term as 'moon' (*mastr'uk*) is used – with names mostly coinciding with those of the main seasonal festivals. Accord-



ing to Peter Parkes (1983, p. 183), who has conducted a year-long systematic investigation of Kalasha time-reckoning in 1975-1977,<sup>36</sup> the count of the days starts with the new moon, which is said to remain 'hidden' for a period varying from 1 to 3 days, with the result that the number of days in all months may vary from 28 to 31.<sup>37</sup> While the progression of the year is generally followed by the people by keeping track of the moon cycles, the exact timing of religious celebrations is determined by observing the place where the sun sets along the crest of the mountains closing the valleys to the west. The dates, therefore do not coincide in the three communities, but they can be predicted in advance by observing the setting of the sun with reference to specific landmarks on the mountain ridges. Parkes (1983, p. 183) relates that the observation is entrusted to some specifically appointed elders (*suri-jagaw'au*) and it is conducted with the aid of 'sun pillars' (*s'uri thū*) erected in a few goat-sheds in each valley. The elders, after comparing their observations, reach an agreement on the date for the beginning of the festival, which is then officially announced.<sup>38</sup>

Though we have no knowledge of any other instance in which the term *cil'a* appears in the Kalasha ritual cycle, the possibility of some sort of parallelism with the ancient Iranian pastoral cycle deserves nevertheless to be investigated: that we are dealing here with an Iranian element seems out of the question, but we may wonder if we are faced with a trait that should be attributed to an ancient common heritage, or rather, as may be more likely, to less remote historical relations. Whether the former is the case, or when and how these may have occurred, are open questions for future research. We only hope that the data we make available here, will offer some support to a similar investigation.

---

36 More generic data collected by us through informants in 1973 coincide pretty much with his.

37 He adds that «there seems to be a hiatus in reckoning days after the end of the Chaomos festival at the midwinter solstice; and there is some suggestion that an intercalary month is (or was) inserted every seven years at the Dewaka rite in January» (Parkes 1983, p. 183); Dewaka is the name of a sacrifice celebrated in the Rumbur valley at the end of January, like the Salgherek of Birir.

38 Parkes (1983, p. 183) notes that the system is quite accurate because the climax of the Chaomos celebrations always coincides with the winter solstice and the dates of the other main seasonal festivals have only varied in a range of 3 or 4 days in the 40 years preceding his observations. In 2006-2007 (the year of our last fieldwork), however, fixed dates had been introduced in the two northern valleys of Bumburet and Rumbur, but not in Birir, where the traditional system was still in use.

## Bibliography

- Allen, Nigel (1991). «Some Gods of Pre-Islamic Nuristan». *Revue de l'histoire des Religions*, 208 (2), pp. 141-168.
- Bashir, Elena (2003). «Dardic». In: Cardona, G.; Dhanesh, Jain (eds.), *The Indo-Aryan Languages*. London: Routledge, pp. 819-894.
- Bellew, Henry W. [1891] (1973). *An Inquiry into the Ethnography of Afghanistan*. London: The Oriental University Institute; Woking. Repr. Graz: Akademische Druck.
- Berremen, Gerald [1963] (1972). *Hindus of the Himalayas*. Berkeley: University of California Press.
- Bhatt, Ram Prasad; Wessler, Heinz Werner; Zoller, Claus Peter (2014). «Fairy Lore in the High Mountains of South Asia and the Hymn of the Garwahli Fairy 'daughter of the Hills'». *Acta Orientalia*, 75, pp. 79-166.
- Biddulph, John [1880] (1986). *Tribes of the Hindu Kush*. Calcutta: Office of the Superintendent of government printing. Repr. Lahore: Ijaz Ahmad; Ali Kamran Publishers.
- Brellich, Angelo (2007). *Il politeismo*. Roma: Editori Riuniti.
- Buddruss, Georg (1960). «Zur Mythologie der Präsun-Kafiren». *Paideuma*, 7 (4-6), pp. 200-209.
- Buddruss, Georg (1973). «Archaisms in Some Modern Northwestern Indo-Aryan Languages». In: Embassy of the Federal Republic of Germany (ed.), *German Scholars on India*, vol. 1. Varanasi: The Chowkhamba Sanskrit Series Office, pp. 31-49.
- Buddruss, Georg (1974). «Some Reflections on a Kafir Myth». In: Jettmar, Karl; Edelberg, Lennart (eds.), *Cultures of the Hindu Kush = Selected Papers from the Hindu-Kush Cultural Conference Held at Moesgård 1970*. Wiesbaden: Franz Steiner, pp. 31-36.
- Buddruss, Georg (2002). «Vom mythischen Weltbild eines Hochgebirgsvolkes im Hindukusch». In: Zeller, Dieter (ed.), *Religion und Weltbild*. Münster; Berlin; Wien; Zürich; London: LIT. Marburger Religionsgeschichtliche Beiträge, 2.
- Buddruss, Georg; Degener Almuth (2015). *Materialen zur Prasun-sprache des Afghanischen Hindukusch*. Cambridge: Harvard University Press.
- Cacopardo, Alberto M. (1985). «Gli infedeli dell'Hindu Kush». *L'Universo*, 65 (6), pp. 700-723.
- Cacopardo, Alberto M. (2009). *Chi ha inventato la democrazia?* [doctoral dissertation] [online]. Sassari: Università di Sassari. Available at [http://eprints.uniss.it/880/1/Cacopardo\\_A\\_Tesi\\_Dottorato\\_2009\\_Chi.pdf](http://eprints.uniss.it/880/1/Cacopardo_A_Tesi_Dottorato_2009_Chi.pdf).
- Cacopardo, Alberto M.; Cacopardo, Augusto S. (2001). *Gates of Peristan: History, Religion and Society in the Hindu Kush*. Roma: IsIAO.
- Cacopardo, Alberto M.; Schmidt, Ruth L. (eds.) (2006). *My Heartrendingly Tragic Story*. Oslo: Novus.

- Cacopardo, Augusto S. (2006). «Anthropomorphic Representations of Divinities among the Kalasha of Chitral (Pakistan)». *Acta Orientalia*, 67, pp. 127-158.
- Cacopardo, Augusto S. (2008). «The Winter Solstice Festival of the Kalasha of Birir: Some Comparative Suggestions». *Acta Orientalia*, 69, pp. 77-120.
- Cacopardo, Augusto S. (2010a). *Natale pagano: Feste d'inverno nello Hindu Kush*. Palermo: Sellerio.
- Cacopardo, Augusto S. (2010b). «Texts from the Winter Feasts of the Kalasha of Birir». *Acta Orientalia*, 71, pp. 187-242.
- Cacopardo, Augusto S. (2013). «La lingua Kalasha e il suo contesto». *Archivio per l'Antropologia e la Etnologia*, 143, pp. 53-72.
- Caroe, Olaf [1958] (1973). *The Pathans*. London: MacMillan & Co. Ltd. Repr. Karachi: Union Book Stall.
- Cristoforetti, Simone (2003). *Il Natale della luce in Iran*. Milano: Mimesis.
- Dumézil, George (1929). *Le problème des Céentaures*. Paris: Librairie orientaliste Paul Geuthner.
- Dumont, Louis; Pocock, David F. (1959). «Pure and Impure». *Contributions to Indian Sociology*, 3, pp. 9-39.
- Dumont, Louis [1966] (1979). *Homo Hyerarchicus*. Paris: TEL Gallimard.
- Duprée, Louis (1971). «Nuristan: the 'Land of Light' Seen Darkly». *The American Universities Field Staff: South Asia Series*, 15 (6), pp. 1-19.
- Edelberg, Lennart (1965). «Nuristanske Sølvpokaler». *KUML*, pp. 153-201.
- Edelman, Džoj I. (1983). *The Dardic and Nuristani Languages*. Moscow: Nauka Publishing House.
- Eliade, Mircea [1948] (1976). *Trattato di storia delle religioni*. Torino: Boringhieri. Or. ed.: *Traité d'histoire des religions*. Paris: Payot, 1948.
- Eliade, Mircea [1975] (1979). *Storia delle credenze e delle idee religiose*, vol. 1. Firenze: Sansoni. Or. ed.: *Histoire des croyances et des idées religieuses*, vol. 1. Paris: Payot.
- Elphinstone, Monstuart [1815] (1969). *An Account of the Kingdom of Caubul, and its Dependencies in Persia, Tartary, and India*. London: Longman, Hurst, Rees, Orme, and Brown, Paternoster-row; J. Murray Albemarle-street. Repr. Graz: Akademische Druck.
- Fussman, Gérard (1972). *Atlas Linguistique des parlers dardes et kafirs*, vol. 1, *Cartes*; vol. 2, *Commentaire*. Paris: Adrien Maisonneuve.
- Fussman, Gérard (1976). «Jettmar, Karl (1975). "Die Religionen des Hinduismus, mit beitrage von Schuyler Jones und Max Klimburg". In: *Die Religionen der Menschheit*, 4 Bd., Bd. 1. Stuttgart: Verlag W. Kohlhammer» [Review]. *Journal Asiatique*, 264 (1), pp. 200-209.
- Fussman, Gérard (1977). «Pour une problématique nouvelle des religions indiennes anciennes». *Journal Asiatique*, 265 (1-2), pp. 21-70.

- Fussman, Gérard (1983). «Nouveaux ouvrages sur les langues et civilisation de l'Hindou-Kouch (1980-1982)». *Journal Asiatique*, 271 (1-2), pp. 191-206.
- Gardner, Alexander [1869] (1977). «A *Scetch on Kaffiristan and the Kaffirs...* With an Introduction by S. Jones». *Afghanistan Journal*, 4 (2), pp. 47-53.
- Ghani-ur-Rahman; Olivieri, Luca (eds.) (2011). «Italian Archaeology and Anthropology in Northern Pakistan (1955-2011)». *Journal of Asian Civilizations*, 34 (1).
- Gnoli, Gherardo (1980). *Zoroaster's Time and Homeland: A Study on the Origins of Mazdeism and Related Problems*. Napoli: Istituto Universitario Orientale.
- Göhlen, Ruth (1997). «The Background of Genealogical Time Structuring and Remembering: Aspects of Time in Astor Valley, Northern Pakistan». In: Stellrecht, I. (ed.), *The Past and the Present: Horizons of Remembering in Pakistan Himalaya*. Cologne: Rüdiger Köppe, pp. 161-195.
- Goody, Jack (1990). *The Oriental, the Ancient and the Primitive: Systems of Marriage and the Family in the Pre-industrial Societies of Eurasia*. Cambridge: Cambridge University Press.
- Harper, Edward B. (1964). «Ritual Pollution as an Integrator of Caste and Religion». In: Harper, E.B. (ed.), *Religion in South Asia*. Seattle: University of Washington Press, pp. 151-197.
- Holzwarth, Wolfgang (1996). «Chitral history, 1540-1660: Comments on Sources and Historiography». In: Bashir, Elena; Israr-ud-Din (eds.), *Proceedings of the Second International Hindukush Cultural Conference*. Karachi: Oxford University Press, pp. 117-134.
- Holzwarth, Wolfgang (1998). «Change in Pre-Colonial Times: An Evaluation of Sources on the Karakorum and Eastern Hindukush Regions (from 1500 to 1800)». In: Stellrecht, Irmtraud (ed.), *Karakorum-Hindukush-Himalaya: Dynamics of Change*. Köln: Rüdiger Köppe, pp. 297-335.
- Holzwarth, Wolfgang. (2006). «Sources of Gilgit, Hunza and Nager History (1500-1800)». In: Kreuzmann, Hermann (ed.), *Karakoram in transition*. Karachi: Oxford University Press, pp. 171-190.
- Hutton, John H. (1946). *Caste in India: Its Nature, Function and Origins*. Cambridge: Cambridge University Press.
- Jettmar, Karl (1974). «Iranian Influence in the Cultures of the Hindukush». pp. 39-43. In: Jettmar, Karl; Edelberg, Lennart (eds.), *Cultures of the Hindu Kush = Selected Papers from the Hindu-Kush Cultural Conference Held at Moesgård 1970*. Wiesbaden: Franz Steiner, pp. 39-43.
- Jettmar, Karl (1975), «Die Religionen des Hindukusch, mit beitrage von Schuyler Jones und Max Klimburg». In: *Die Religionen der Menschheit*, Bd. 1. 4 Bd.. Stuttgart: Verlag W. Kohlhammer.
- Jettmar, Karl (1986). *The Religions of the Hindu Kush: The Religion of the Kafirs*, vol. 1. Warminster: Aris & Phillips.

- Jettmar, Karl; Edelberg, Lennart (eds.) (1974). *Cultures of the Hindu Kush = Selected Papers from the Hindu-Kush Cultural Conference Held at Moesgård 1970*. Wiesbaden: Franz Steiner.
- Jones, Schuyler. (1974). *Men of Influence in Nuristan*. London: Seminar Press.
- Karve, Irawati (1953). *Kinship Organization in India*. Poona: Deccan College Postgraduate and Research Institute. Deccan College Monograph Series, 11.
- Klimburg, Max (1976). «Male-Female Polarity Symbolism in Kafir Art and Religion: New Aspects in the Study of the Kafirs of the Hindu Kush». *East & West*, 26 (3-4), pp. 479-488.
- Klimburg, Max (1999). *The Kafirs of the Hindu Kush*. 2 vols. Stuttgart: Franz Steiner Verlag.
- Kreutzmann, Hermann (2005). «Linguistic Diversity in Space and Time: A Survey in the Eastern Hindu Kush and the Karakoram». *Himalayan Linguistics*, 4, pp. 1-24.
- Kuiper, Franciscus B. (1970). «Cosmogony and Conception: A Query». *History of Religions*, 10 (2), pp. 91-138.
- Leach, Edmund R., (ed.) [1960] (1969). *Aspects of Caste in South India, Ceylon, and North-West Pakistan*. Cambridge: Cambridge University Press.
- Lentz, Wolfgang (1974). «Western Parallels to the Deeds of Imra». In: Jettmar, Karl; Edelberg, Lennart (eds.), *Cultures of the Hindu Kush = Selected Papers from the Hindu-Kush Cultural Conference Held at Moesgård 1970*. Wiesbaden: Franz Steiner, pp. 37-38.
- Levy, Robert I. (1990). *Mesocosm: Hinduism and the Organization of a Traditional Newar City in Nepal*. Berkeley: University of California Press.
- van Lohuizen-de Leeuw, Johanna E. (1959). «An Ancient Hindu Temple in Eastern Afghanistan». *Oriental Art*, 5 (2), pp. 61-69.
- Loude, Jean-Yves; Lièvre, Viviane (1984). *Solstice païen*. Paris: Presses de la Renaissance.
- Masson, Charles [1842] (1975). *Narrative of Various Journeys in Balochistan, Afghanistan, The Panjab and Kalat, During a Residence in Those Countries, to which is Added an Account of the Insurrection at Kalat and a Memoir on Eastern Balochistan*, vol. 1. 4 vols. London: Richard Bentley. Repr. Graz: Akademische Druck - u. Verlagsanstalt.
- Mohan Lal [1846] (1971). *Travels in the Panjab, Afghanistan and Turkistan, to Balkh, Bokhara, and Herat; and a Visit to Great Britain and Germany*. London: H. Allen & Co. Repr. Patiala: Language Department Punjab.
- Morgenstierne, Georg (1944). «The Pashai Language: Texts and Translations. With Comparative Notes on Pashai Folktales by Reidar Th. Christiansen». In: *Indo-Iranian Frontier Languages*, vol. 3, part 2. Oslo: Pub.

- Morgenstierne, Georg (1947). «The Spring Festival of the Kalash Kafirs». In: *India Antiqua: A volume of Oriental Studies presented to J.P. Vogel*. Leyden: Kern Institute, pp. 240-248.
- Morgenstierne, Georg (1949). «The Language of the Prasun Kafirs». *Norsk Tidsskrift for Sprogvidenskap*, 15, pp. 188-334.
- Morgenstierne, Georg (1951). «Some Kati Myths and Hymns». *Acta Orientalia*, 21, pp. 161-89.
- Morgenstierne, Georg (1973). *Indo-Iranian Frontier Languages: The Kalasha Language*, vol. 4. Oslo: Institute for Comparative Research in Human Culture.
- Morgenstierne, Georg (1974). «Languages of Nuristan and Surrounding Regions». In: Jettmar, Karl; Edelberg, Lennart (eds.), *Cultures of the Hindu Kush = Selected Papers from the Hindu-Kush Cultural Conference Held at Moesgård 1970*. Wiesbaden: Franz Steiner, pp. 1-10.
- Munphool, Meer (1869). «On Gilgit and Chitral». *Proceedings of the Royal Geographical Society*, 13, pp. 130-133.
- Nicholas, Ralph W. (1981). «Shraddha, Impurity and Relations Between the Living and the Dead». *Contributions to Indian Sociology*, 15 (1-2), pp. 367-379.
- Parkes, Peter (1983). *Alliance and Elopement: Economy, Social Order and Sexual Antagonism among the Kalasha (Kalash Kafirs) of Chitral* [doctoral dissertation]. Oxford: Oxford University.
- Parkes, Peter (1987). «Livestock Symbolism and Pastoral Ideology Among the Kafirs of the Hindu Kush». *Man*, n.s., 22, pp. 637-660.
- Pettazzoni, Raffaele (1957). *L'Essere Supremo nelle religioni primitive*. Torino: Einaudi.
- Raverty, Henry G. [1880] (1976). *Notes on Afghanistan and Part of Baluchistan, Geographical, Ethnographical and Historical, Extracted from the Writings of Little known Afghan and Tajik Historians*. London: Eyre & Spottiswoode. Repr. Lahore: Niaz Ahmad Sang-e-Meel Publications.
- Rennell, James. (1792). *Memoir of a Map of Hindoostan; or the Mogul Empire: The Second Edition with very considerable additions, and many corrections*. London: W. Bulmer and Co.
- Robertson, George S. [1896] 1974. *The Kafirs of the Hindu Kush*. London: Lawrence and Bullen Ltd. Repr. Karachi: Oxford University Press.
- Sabatucci, Dario (1998). *Il politeismo*. 2 voll. Roma: Bulzoni.
- Scarcia, Gianroberto (1965). *Sifat-Nama-yi Darvis Muhammad Han-i Gazi*. Roma: IsMEO.
- Sergent, Bernard (1997). *Genèse de l'Inde*. Paris: Payot & Rivages.
- Sergent, Bernard [1995] (2005). *Les Indo-Européens*. Paris: Payot & Rivages.
- Snoy, Peter (2008). «The Rites of the Winter Solstice among the Kalash of Bumburet». *Journal of Asian Civilizations*, 31 (1-2), pp. 36-64.



- Stutley, Margaret; Stutley, James (1980). *Dizionario dell'Induismo*. Roma: Ubaldini. Trad. di: *A Dictionary of Hinduism, Its Mythology, Folklore and Development*. London: Routledge & Kegan Paul, 1977.
- Strand, Richard F. (2001). «The Tongues of Peristan». In: Cacopardo, Alberto M.; Cacopardo, Augusto S., *Gates of Peristan: History, Religion and Society in the Hindu Kush*. Roma: IsIAO, pp. 251-259.
- Tucci, Giuseppe (1963). «Oriental Notes (II): An Image of a Devi discovered in Swat and Some Connected Problems». *East & West*, 14 (3-4), pp. 146-182.
- Turner, Ralph L. (1966). *A Comparative Dictionary of Indo-Aryan Languages*. London: Oxford University Press.
- Van Gennep, Arnold [1909] (1981). *I riti di passaggio*. Torino: Boringhieri. Or. ed.: *Les rites de passage*. Paris: Emile Nourry.
- Van Skyhawk, Hugh (ed.) (2008). «Masters of Understanding: German Scholars in the Hindu Kush and Karakoram, 1955-2005». *Journal of Asian Civilizations*, 31 (1-2).
- Wessels, Cornelius [1924] 1997. *Early Jesuit Travellers in Central Asia, 1603-1721*. The Hague: Martinus Nijhoff. Repr. New Delhi: Asian Educational Services.
- Witzel, Michael. (2004). «The Rgvedic Religious System and Its Central Asian and Hindu Kush Antecedents». In: Griffiths, A.; Houben, J.E.M. (eds.), *The Vedas, Texts, Language & Ritual = Proceedings of the Third International Vedic Workshop* (Leiden 2002). Groningen: Egbert Forsten, pp. 581-636.
- Wood, John [1841] (1872). *A Journey to the Sources of the River Oxus: New Edition, Edited by His Son, with an Essay on the Geography of the Valley of the Oxus by Colonel Henry Yule*. London: John Murray.
- Wutt, Karl (1983). «Chaumos = 'Vier Mal Fleisch': Notizen zum Winterlichen Festkalender der Kalash von Bumburet, Chitral». *Archiv für Völkerkunde*, 37, pp. 107-148.
- Zoller, Claus Peter (2010). «Aspects of the Early History of Romani». *Acta Orientalia*, 71, pp. 243-312.



## Borders

Itineraries on the Edges of Iran

edited by Stefano Pellò

# Transregional Intoxications Wine in Buddhist Gandhara and Kafiristan

Max Klimburg  
(Universität Wien, Österreich)

**Abstract** The essay deals with the wine culture of the Hindu Kush area, which is believed to be among the oldest vinicultural regions of the world. Important traces and testimonies can be found in the Gandharan Buddhist stone reliefs of the Swat valley as well as in the wine culture of former Kafiristan, present-day Nuristan, in Afghanistan, which is still in many ways preserved among the Kalash Kafirs of Pakistan's Chitral District. Kalash represent a very interesting case of 'pagan' cultural survival within the Islamic world.

**Keywords** Kafiristan. Wine. Gandhara. Kalash.

Dionysus, the ancient wine deity of the Greeks, was believed to have originated in Nysa, a place which was imagined to be located somewhere in Asia, thus possibly also in the southern outskirts of the Hindu Kush, where Alexander and his Army marched through in the year 327 BCE. That wooded mountainous region is credited by some scholars with the fame of one of the most important original sources of the viticulture, based on locally wild growing vines (see Neubauer 1974). Thus, conceivably, it was also the regional viniculture and not only the (reported) finding of much of ivy and laurel which had raised the Greeks' hope to find the deity's mythical birth place. When they came across a village with a name similar to Nysa, the question appeared to be solved, and the king declared Dionysus his and the army's main protective deity instead of Heracles, thereby upgrading himself from a semi-divine to a fully divine personality. All this happened in an area then inhabited – one is led to speculate – by ancestors of the Kafirs of the Hindu Kush living in that part of Great Kafiristan.

These isolated mountain peoples in Northeastern Afghanistan, called *kāfir* (unbelievers) by their Muslim neighbours after Islam had conquered the region around them, inhabited the valleys of Kafiristan to the south of the main ridge of the Hindu Kush mountain range (fig. 1). They adhered to age-old shamanistic/polytheistic beliefs and led a socio-religious festive life in part enlivened by wine-based 'Dionysian' features, with their Indian deity Indr acting as their wine god, until they were Islamized by

force in 1895-1896 and *Kāfiristān* was renamed *Nūristān*.<sup>1</sup> Was there any relationship between the two wine gods? Greeks sources do not provide any information in these regards.

Dionysus must have felt 'comfortable' among the mountain peoples of Great Kafiristan and their vigorous life style, dominated by much feasting with wine, music and dancing. Under the likely assumption that groups of these mountain dwellers came into some contact with the Greeks, one can envision that they were deeply impressed by the images of power and splendour of the Greeks' camps, equipment, arming, and their wine culture with characteristic drinking vessels.<sup>2</sup> Possibly, they also participated in some Dionysian feasts held by the soldiers. Nothing of such contacts is really known, but M.L. Carter states that the troops «lingered there with the natives to attend bacchanalian celebrations» (1992, p. 53). One may also assume that the natives supplied the Greeks with locally produced wine, though not much of it could have been available, as it was made only from grapes laboriously picked high up in trees climbed by wild growing vines. Whatever, the stage was set for much of Greek influence to come in regions already 'flush' with wine, where the knowledge of wine-making was already wide-spread, communicated for a long time in the Eurasian network including the Ancient Wine Roads, forerunners of the Silk Roads (Kupfer 2014, p. 24).<sup>3</sup>

The impact of the wine culture in the regions presently discussed can hardly be overestimated, as this can be said, of course, with regard to all the regions strongly affected by viticulture at any time, going back to the 'dawn of viniculture' in prehistoric times, when the grapes were picked only from wild growing vines, as documented at many places in Iran and neighbouring regions (see McGovern 2014). Obviously, it was only after the vine's 'domestication' to grow in properly tended vineyards that wine was made available in large quantities such as for the Achaemenid rulers, who

---

1 In Chitral, NW-Pakistan, the related culture of the small minority of the Kalash Kafirs, the 'Kafirs of Pakistan', was spared Islamization and hence survived up to the present.

2 Indeed, several Kafir objects such as silver cups, tripod iron stands (figs. 17-18) and daggers (fig. 20) recall ancient Greek models - with e.g. the Kafir dagger *katara* resembling the Greek *akinakes*. More than two millennia later some Europeans invented the still wide-spread tale that the Kafirs/Nuristani are descendants of Alexander's Greeks who had slept with local girls or had settled among the locals, enjoying their life style and wine.

3 Kupfer thinks of an extensive wine-related exchange in Eurasia «since at least as early as Neolithic times; thus it existed long before the Silk Road, and perhaps could be labelled *Ancient Wine Road*». He assumes a «quantum leap in the history of evolution and civilization» by «the discovery and use of fermentation» of wine in particular in the rise of civilizations (2014, pp. 33 ff.). Jäger favours important influences of Iranian-speaking peoples on the development of wine cultures (2014, p. 44). His thesis should be expanded to include in particular Indo-Iranian peoples living in eastern Afghanistan and historical Northwestern India, thus in and around the Hindu Kush with its particular kind of wild vine called *vitus nuristanica*.

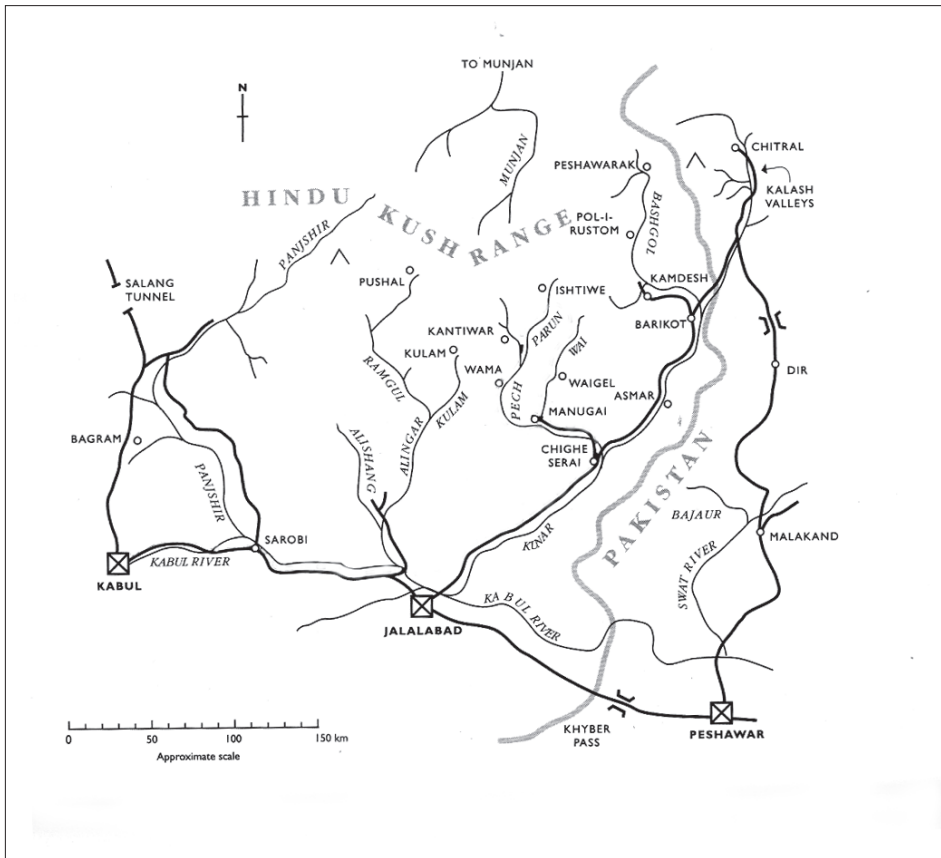

Figure 1. Map of Nuristan (source: Barrington et al. 2006, map B, p. 8)

used to partly pay with wine their officials and even many of their workmen. Wild growing vines in more distant mountain areas then lost their former importance for wine making due to the impact of Islam, but those in the southern outskirts of the Hindu Kush mountain range, certainly among the regions with the most favourable growing conditions, could keep their importance for local viticulture in valleys inhabited by the Kafirs of the Hindu Kush up to the end of the nineteenth century (and up to the present among the Kalash Kafirs). Climbing, by preference, holly oak trees, whose small leaves allow enough sunlight to reach them, these vines grow both kinds of grapes, which are then eaten in present Nuristan and still made to wine by the numerically much inferior Kalash Kafirs.

Some three hundred years after those Greeks' 'visit' to the region, then a part of Great Kafiristan, and less than a century after the fall of the Greek

Bactrian kingdom, which for some time had also expanded from Afghanistan into much of (historical) Northwestern India (with Taxila as its centre), where an Achaemenid province known under the (Hellenized) name of Gandhara had existed before, an astoundingly popular development of Buddhism took place there. Countless Buddhists, those-to-become as well as sculptors and stone cutters from near and far founded monasteries or retreated into them, settled near them and worked for them. Eventually the plains and many of the valleys were literally dotted with monastic establishments and stupas richly decorated with Buddhist statues and reliefs summarily called the Buddhist art of Gandhara, which impressed Europeans with such Hellenistic features that the designation 'Graeco-Buddhist' came into use.

The reasons for such an upswing of Buddhism in historical Northwestern India were certainly manifold, starting with the lure of wine-based and spirited cultures embedded in lush valleys with temperate climate and abounding with fertile fields, orchards, vineyards, and with 'air-conditioning' forests around, as existing in the mountain outskirts such as, at its best, in the Swat valley.<sup>4</sup> There is also the change, possibly having started there, from the centuries-old awe regarding images of Buddha, who therefore was not represented before, to more popular tendencies favouring such imagery, as if inspired by nearby Greek foundations with their natural looking stone images of deities and leading men.<sup>5</sup> That circumstance then led to the 'swamping' of Buddhist monasteries and holy sites with respective imagery in stone, clay and stucco, and it must have contributed largely to the vast Buddhist expansion which appears to have been carried, among others, by unfettered image-worship probably accompanied by wine-based 'lustfulness' in spite of the Buddhist preaching of 'lustlessness'.

With Buddhism thus firmly established there in the first centuries CE, based on the rich local agriculture and also on Greek and other influences from townships such as Taxila and Peshawar, based also on the good income from trading with goods from West, Middle-central, East and South Asia as well as from pilgrimage, remarkably strong missionary tendencies developed and led to the Buddhist expansion along the trade routes forming part of the so-called Silk Roads across the mountain barriers into Middle and Central Asia and finally East Asia. Gandhara thus became the spring-board for the momentous spreading of one of the world's most successful revolutionary spiritual movements and redemption concepts along

---

4 That valley constituted, together with the small part of Kashmir belonging to Pakistan, the most favoured summer resort of Pakistan until its recent short lived, horror-spreading domination by the Taliban.

5 The question whether the first images of Buddha were created in Gandhara or in Mathura in northern India continues to be hotly debated.



Figure 2. Door jamb from Butkara (Swat) with an erotic couple above a Buddha figure (Faccenna 1964, pl. CCLXXXIX)

roads which had already become an important network of trade routes spreading since long time also the knowledge of wine culture and thus conceivably denominated Ancient Wine Roads.

All the Buddhist messages of salvation by abstention, spread by very numerous monastic centres with their often colossal images of Buddha and innumerable Buddhist monks and pilgrims mixing with the population, had hardly affected the local wine-drinking cultures with their Dionysian feasts and orgies combined with much music, dance, and eroticism. Accordingly, many Buddhists may well have fallen prey to the lures of wine





Figure 3. Male figures pressing grapes with their feet and a stick, filtering and possibly also tasting wine and resting inebriated, as seen to the left. Relief, Peshawar Museum (Ingholt 1957, p. 104, fig. 175)



Figure 4. Dionysiac scene with a fat, nude Silenus and another figure riding on lions, a man standing in a vat and pressing grapes with his feet, a man pouring wine out of a skin bag into a krater, and several male and maenad-like female figures set in sceneries of vines. Relief, Lahore Museum (Ingholt 1957, p. 157, fig. 397)



Figure 5. A Dionysiac scene with men and women dancing and playing musical instruments, possibly made tipsy by the wine which is being poured out of a shouldered skin bag into a large krater-like vessel. Relief, private collection, Switzerland (Jäger 2015, fig. 1)

and wine-enhanced erotic desires, and the resulting sensuous facets in the appearance of Buddhism may have participated not only to its great spread across the mountains, but also to more esoteric creeds spiced by erotic features, leading towards Vajrayana-Buddhism.

It should not surprise, therefore, to find numerous Buddhist Gandhara reliefs showing also very non-Buddhist images of wine drinking, revelries and eroticism (figs. 2-5), as already commented on in 1992 by M.L. Carter, who focused on the Dionysian features of the popular folk religion of the region, already discussed by her with reference to Kushan art in an earlier article.<sup>6</sup> More recently, A. Filigenzi, a long time member of the Italian Archaeological Mission to Swat, Pakistan, picked up that topic in a still unpublished article<sup>7</sup> with special reference to Swat, which may well have been an area where more than anywhere else the wine cultures of Great Kafiristan flourished near Buddhist monasteries, where a special impetus may have inspired the development of esoteric beliefs eventually leading to the formation of Vajrayana Buddhism. Tellingly, the Swat Valley can be identified with the holy land of Uḍḍiyāna referred to in Tibetan Tantric sources.

Filigenzi also stresses the impact of wine and wine-related dances and sensuality on the local socio-economics in spite of the Buddhist damnation of all that. She draws attention to numerous stone tanks carved out of the rock, which must have served as wine-presses and vats such as those of the Kafirs and in the Pashai habitat, to the numerous chalice-like ceramic objects and distilling vessels excavated at different archaeological sites in Swat, datable to the first-third century CE, also known as the 'Kushan period' (disregarding here the local proto-historic finds which include bowl-like drinking vessels).<sup>8</sup> Her paper focuses in particular on some reliefs of unknown but certainly Gandhara origin showing scenes of wine drinking, of erotic content and of Dionysian looking dances next to Buddhist images or on separate stone pieces. As already imaged by Carter, this appears to reflect a non-Buddhist tribal and cultural environment in the sense of Great

6 She attempted «to explain this puzzling and seemingly inappropriate element in Gandharan Buddhist art as an outgrowth of the popular folk religion of the region, particularly in the cool highlands surrounding the Gandhara plain where grapes were cultivated and wine drinking was documented from the time of Alexander's invasion» (Carter 1992, p. 51). There was certainly much wine drinking already long time before Alexander. Carter refers to several characteristic reliefs which are also used by Filigenzi to illustrate her paper. With Carter's additional references to the culture of the Kafirs and the relevant findings in Edelberg (1965), she shares many insights with the present author.

7 When read in Vienna on 8 October 2014, on the invitation of a local NGO, the title of her paper was slightly changed to «Dionysos in India. Stereotypes about Inebriation in the Buddhist art of Gandhara». I am very grateful to Dr. Filigenzi for allowing me to refer to her findings before their publication.

8 Among the numerous references given by Filigenzi, only those to Olivieri (2008 and 2011) and Falk (2009) are included among the references here.



Kafiristan, where the consumption of wine and revelries must have been widespread. One can thus suppose important interactions in both the economic and cultural field with the monasteries and their urban background as well links to the outside world. Therefore, reasoning with Filigenzi, the monastic communities were probably forced to some liberal attitudes, not only with respect to the use of wine for medical reasons. As most monastic communities are known worldwide for their roles not only in trading and providing shelter, with the Buddhist ones along the Silk Road providing best examples, but also in wine making, the suspicion is thus great that also the Buddhist monastic settlements in Gandhara had fallen victim to the lure of wine and even wine making (see Falk 2009).

As to the social and religious background of the wine-loving and dancing people depicted in those non-Buddhist scenes, one can imagine that they were local laymen, and among them, according to Filigenzi, sponsoring members of the local aristocracy represented as more ceremonial wine-drinkers. Wine consumption was probably even more popular, combined with dancing, among the sculptors and stone cutters working for the monasteries and their sponsors as well as with the nearby mountain peoples, who may well be regarded, as already stated, as ancestors (in the widest sense) of the «Kafirs of the Hindu Kush», who then became famous for withstanding until most recent times, in part even to the present, all the alcohol-prohibiting Islamization around them.

The love of wine by the ancestors of the Kafirs of the Hindu Kush was certainly known for millennia and thus also to the Greeks of Alexander who, however, did not leave us any related information. It was only much later, in the sixteenth and seventeenth centuries, that the first known reports were written, provided by Timur Leng and then Babur, the first Moghul ruler. The latter even mentioned with reference to southern Kafiristan «strong yellowish wines ... all brought from up the Kafiristan-water and from Pich-i-kafiristani».<sup>9</sup> Some information on the Kafirs is contained in the late eighteenth-century manuscript *Sayr al-Bilād* by Moghul Beg,<sup>10</sup> and in the early nineteenth century, M. Elphinstone was able to collect some substantial data when charged with researching on the Kingdom of Caubul. As told by informants sent into Kafiristan, he reported that the Kafirs «drink wine, both pure and diluted, out of large silver cups, which are the most precious of their possessions. They drink during their meals, and are elevated, but

9 With the notion 'Pich-i-kafiristani', i.e. the Kafirs of the Pech Valley, Babur indicated the centre of the Kafir wine production which was in and near the Pech Valley in southern Kafiristan. Another wine centre was in Dara-ye-Nur Valley, a side valley of the Kunar Valley. Babur was also good for absurd statements such as that «wine is so commonly used there that every Kafir has his leathern wine-bag (*khig*) at his neck, and drinks wine instead of water» (1922, 1, p. 212). Naturally, wine was carried in goatskin bags for any reason such as for sale.

10 The manuscript was translated by Raverty and published in Raverty 1888.

not made quarrelsome, by this indulgence» (1839, p. 384). The mention of silver cups must have caused much attention and even amazement, but they remained undocumented and thus of doubtful existence until 1953.

Charles Masson, the British adventurer and explorer who in the 1830s roamed through Afghanistan and around, wrote that the «Káfrs» or, rather, «Síáposh»,<sup>11</sup> were «fond of [...] singing and drinking wine» out of «drinking cups and bowls [which] are ornamented and embossed in a costly manner», thereby referring certainly to silver cups. He reported that he had seen Kafirs «bringing wine in skins, and so sour as to be undrinkable. It is said, however, that they have good wine, and that the better classes, in default of jars, preserve it in cisterns, hewn in the rock» (1842, 1, p. 228). Alexander Burnes, the British political agent in Kabul in the late 1830s, heard of Kafir Kafirs drinking «light and dark» wine from silver cups and thought them to be «trophies of their spoils in war» (p. 211). «One would [...] in that case have expected that the greatest numbers of cups would have been found among the strongest tribe in Kafiristan, the Kam people in lower Bashgal» (Edelberg 1965, p. 196).

However, this was not the case, when (Sir) George Scott Robertson, a British Indian government commissioner, in 1890-1891 resided one year among the Kam Kafirs in the Basghal Valley, in particular in Kamdesh, in eastern Kafiristan (to the west of the Afghan-Pakistan border). His book *The Káfirs of the Hindu-Kush* is the only existing major field report. However, this first-hand knowledge of the Kafirs is limited to those living in the east and, to a very small degree, to the numerically inferior Parun Kafirs dwelling in the centre. He collected very little or no information on the Waigal and Ashkun Kafirs living in the south and south-west, that is those inhabiting valleys with wild growing vines. The Kati speaking Kafirs in Northwestern Kafiristan, closely related to those in the east, were out of his reach altogether. Accordingly, we understood under Kafirs only the eastern Kati speakers and their culture as described by Robertson. Only recent research clarified that the many social-cultural differences between the Kafirs speaking the Kati, Waigali/Ashkun and Paruni languages, all classified as Indo-Iranian in a special archaic sense,<sup>12</sup> indicate the former existence of three distinct Kafir cultures corresponding to these three main idioms. One of them, namely the culture of the Parun Kafirs had no viticulture due to the lack of locally growing wild vines.

During his stay among the Kafirs residing in the Bashgal Valley, Robertson saw mostly wooden cups and occasionally shallow tin bowls used

11 'Síáposh' or 'black-clad' is the epithet once given to the Kafirs living in the Bashgal Valley (with the village of Kamdesh) in easternmost Kafiristan, while their western neighbours, the Parun Kafirs, were known as 'Safedposh' or 'white-clad'.

12 Morgenstierne (1961) classified these 'Kafir' languages as belonging to a very early offshoot of the Indian branch of the Indo-Iranian language group.



Figure 6. The treading of grapes in Kamdesh (Robertson 1896, pl. at p. 558)

for wine drinking. On festive occasions the «dancers refreshed with wine ladled from a tub with wooden cups. The same not particularly generous fluid was also circulated among the spectators constantly [...] The grey-beards and seniors, all importance, sat round the dancing platform drinking wine and talking politics» (1896, pp. 223-224.) Only at large gatherings «wine is sometimes handed around in shallow tin bowls, but these are rare as compared to those made of walnut-wood» (p. 501).<sup>13</sup> Tellingly, as the consumption of mostly watered-down wine was probably moderate for lack of sufficient supply and possibly also for reason of status-like behaviour, Robertson did not observe any drunkenness (p. 559). There is no reference to silver cups, and, indeed, such cups were only discovered as part of the Waigal/Wama culture in 1955.

<sup>13</sup> These 'shallow tin bowls' were certainly different from the eye-catching chalice-like silver cups used in the Waigal Valley and in Wama and the «large silver cups» mentioned by Elphinstone (1839) and Burnes (1842).

Unfortunately, Robertson tells us little about the local viticulture and nothing with respect to the growing of vines and the picking of grapes. He describes a wine press on a flat-topped boulder, with its side walls made by small boulder and stone walls about two and half feet high, with their interstices filled with clay. The somewhat semi-circular press measured some five and a half feet in length and some four feet at its breadth. «The floor sloped naturally, and at the lower end, in front, an aperture had been left, partly closed by a little brushwood, from under which a deeply-grooved piece of wood [...] protruded, and afforded an outlet for the expressed juice» (pp. 556, 559). Then a big man was asked to tread the grapes, after his feet had been washed carefully. «He enjoyed himself thoroughly, with so much vigour that he had to be frequently checked to prevent the juice from overflowing the vessel» (fig. 6, pp. 558 f.). Then the juice was collected in large wooden cups and poured into goatskin bags with the help of a wooden funnel. After eight to ten days it became wine, which then was drunk without any straining, and therefore the Kafirs always blew into the cups or bowls in order to remove the scum from near their lips. Robertson observed wine drinking on several festive occasions and as a guest of an influential Kafir, who offered him wine which «was strong and good, and was declared to be three years old» (p. 234). He also stated that wine could be kept in goatskins for years, readily available when feasting.

Robertson also observed the pressing of the remaining semi-solid residue with the help of flat stones placed on small heaps of residue and «a long pliable pole used as a lever»: one end of it was anchored in the ground and its free end pulled down by a number of men, thereby pressing the underlying stones. «The dried residue is made up into cakes» tasting «most unpleasant», but «highly appreciated by Kafirs who believe that it possesses most sustaining qualities» (pp. 559 f.).

Robertson was thus the first and last foreign eyewitness to the important role of wine in the local Kafir lifestyle during the abundant feasting on a variety of secular and religious festive occasions. As status-seeking dominated every aspect of life, attained through elaborate honorific feasts, also called 'feasts of merit', and, on a minor scale, through homicidal acts affecting potential or real enemies (the victims being other Kafirs or Muslims both male and female), there was ample opportunity for celebrations and singing and dancing – and wine drinking as long as there was any available. Apparently there was a need for more of this in the distant past, as the Waigal Kafirs allegedly paid «a yearly tribute of four cows and four measures of wine» to the Kam Kafirs, before they settled down in Kamdesh and the lower Bashgal (1896, p. 158).

As already stated, the Kafir viticulture was part of very old Indo-Iranian cultures in a wider region which saw the crossing of Indo-Aryan peoples from Middle/Central Asia to India, and which has a rich vegetation including wild vines. Hidden in badly accessible mountain valleys of the Hindu





Figure 7. The village of Wama 400 m above the Pech River, with the Indrak'un garden to the left (photo: M. Klimburg, 1973)

Kush and only occasionally disturbed by hostile outsiders such as in particular their Muslim neighbours, the Kafirs had managed for millennia to keep to their animistic and polytheistic beliefs together with a large spectre of specific socio-cultural concepts and traditions, until they had to face the destruction of their civilisation. In the winter of 1895-1896 they were subjugated by the Afghan army ordered to smash the Kafir cultures and Islamize the population. Accordingly, the army and the mullahs in its train saw to a wholesale destruction of the Kafir temples and idol imagery as well as rooting-out of all the millennia-old beliefs and very rich, multi-faceted 'heathen' traditions, including their homicidal tendencies which had threatened constantly their lives outside of their communities, and, of course, their viticulture. Kafiristan was renamed *Nūristān*, 'Land of Light' (or 'Enlightenment'), and the formerly militant Kafirs became the comparatively peaceful *Nūristānī*. Only a small, distantly related side branch known as the Kalash Kafirs survived in Chitral, which then was part of Northwestern British India, at present in Northwestern Pakistan. Among them, known under their tourism-stimulating name Kafirs of Pakistan, one still finds a thriving viticulture.

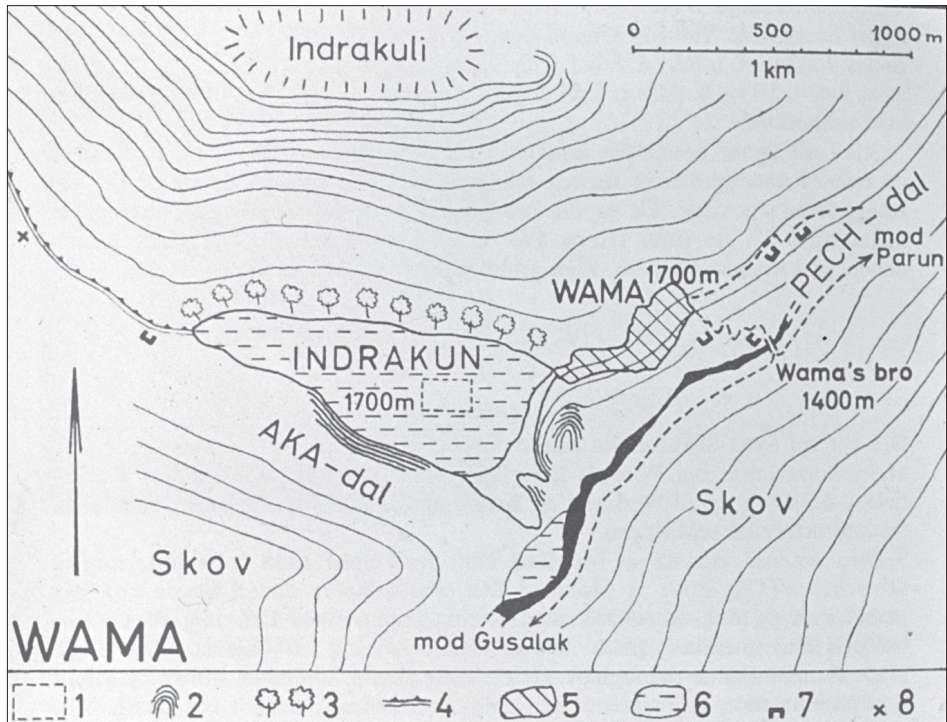

Figure 8. Map of Wama and the Indrak'un garden (Edelberg 1965, fig. 9)

After that drama of 1895-1896 no field research except for a short 'tour de prospection' by the Deutsche Hindukusch Expedition in 1935 (see Scheibe 1937) took place for a half-century until 1948, when Danes started their numerous field trips, with Lennart Edelberg as their main explorer.<sup>14</sup> Already during his first trip Edelberg made an important discovery, when an informant led him into the mythical community-owned forest/orchard/'vineyard' and wine-making centre *Indrak'un*, the 'garden' of the deity Indr (the Kafir version of the Vedic deity Indra), located at 1,850 near the large village of Wama in the Pech Valley (figs. 7-8). That is possibly the centre of Babur's region 'Pich-i-kafiristani', known for its wealth of wild growing vines enjoying favourable climatic conditions and an abundance of 'best-suited' climbable trees, especially holly-oaks. Then, in 1953, in the Waigal village of Zhönchigal, Edelberg was the first re-

<sup>14</sup> Unfortunately, Edelberg was not a social or cultural anthropologist, but a botanist by profession, who developed sympathies for the oppressed, formerly enslaved craftsmen *bari* and servant-like *šuwala*, rather than for their often very self-conscious but better informative former masters, the heirs to the upholders of the Kafir civilisation.





Figure 9. Wine press in the Indrak'un garden (see also fig. 10) (photo: M. Klimburg, 1974)

searcher to see, to his great amazement, two of the 'ominous' silver cups, known before only from hearsay (fig. 13). They turned out to be surprisingly large and stemmed chalice-like vessels.<sup>15</sup> Numerous such cups then appeared soon afterwards, mostly in the Waigal Valley (figs. 14-16, 18).<sup>16</sup> Obviously, nothing could document better the great importance wine once had in particular in southern Kafiristan.

The location of the Indrak'un 'garden', a small forest of large holly oak, walnut and other fruit trees literally embraced by wild vines, on an inclined terrace with a rock facade high above the Pech River, is an extraordinary scenic feature in the otherwise very narrow valley. From that rock wall people could be thrown to their death when found guilty

15 See Edelberg 1965 (in Danish, with an English summary). Much afraid of causing a rush of antique dealers to Nuristan, Edelberg kept the great news of the discovery secret for twelve years.

16 A dozen or more silver cups are known to have survived in museum collections, but the three cups formerly in the author's collection in Kabul and then donated to the National Museum of Afghanistan in 1978 (see Klimburg 1981) were stolen during the recent civil war. One or the other cup may be left in Nuristan.





Figure 10. Man in wine press in the Indrak'un garden (photo: M. Klimburg, 1974)



Figure 11. Stone vat in the Indrak'un garden (photo: M. Klimburg, 1973)

of a serious misdemeanour such as grape-picking before the time of its announcement.<sup>17</sup>

The garden is also most noteworthy for its mythical origin owing to the god Indr, the most popular deity of Wama and Ashkungal (the region of the Ashkun speakers inhabiting the south-west of Nuristan), who was thought to visit Indrak'un each summer. Indr was credited for having founded the garden after he had tricked his brother Giwish/Gish into choosing a piece of land in the Kantiwo Valley at some distance to the north of Wama. When Giwish found out about the great beauty of orchard created by Indr, he tried in vain to destroy it by rolling large boulders down from the mountain behind the garden. Indr made the best of it, as the story goes, by carving vats into several of these boulders to be used for wine making, as he was thought to be a great wine lover. There are four such vats, with one of them made to

<sup>17</sup> The harvest of all the fruits and crops was strictly regulated in every Kafir community, as is mostly still the case in Nuristan.

press the grapes (figs. 9-11).<sup>18</sup> The other three, holding 840, 1,330 and 3,780 litres respectively (Edelberg 1965, p. 171), served to produce wine called *čūkūra* by simply letting the juice ferment under a protective against twigs and leaves (W 9). According to Edelberg's fieldnotes, several days after the pressing and filling of the stone vats with the juice, men sat on the stone near the vats and drank some of the fermenting juice out of wooden cups.

The Indrak'un wine, being community property, had to be distributed among the eligible adult men, numbering some 300 in 1948 (Edelberg 1965, p. 171), according to social criteria, thus most probably not, as Edelberg was told, in equal shares of 10 litres. Naturally, families headed by men with high social merits through feast giving and acts of heroism had the right to larger quantities of wine than the average households of 'free', eligible men. Socially dependent families and, even more so, those occupying a slave-like and untouchable-like status such as the craftsmen known as *bari* and the even lower classified servant-like *šūwala*, groups classified as ethnic outsiders, had no access to wine – such as women.

In the garden there was also a large cult place in Indr's honour known as *Indr-tā* (fig. 12). Its centre consisted foremost of a small boulder which served as basis of Indr's effigy, and a large juniper tree next to it, already dead in 1948. «On the trunk of this tree (or perhaps on a post nearby – or possibly on three posts, one for each of the main clans of Wama) the Kafirs used to hang [...] rings of almond withes on wooden plugs hammered into the trunk or post(s) – presumably one ring (*dāl*) for every Muslim killed» (Edelberg 1965, p. 165).<sup>19</sup> Normally the effigy of Indr, most probably represented standing, was kept in his temple, the *Indr-amā*, inside the village, but on the occasion of a large feast in his honour soon after the grape harvest the figure was carried to the *Indr-tā* and placed on the said stone block. There it then served as the central cult image honoured by the sacrifice of numerous he-goats and one or two oxen, whose blood was thrown on the sacrificial fire,<sup>20</sup> while men acting as priests and worshippers said thanksgiving prayers and sang hymns. Specific to Wama and possibly also

---

18 K. Wutt photographed similar stone vats in Darra-ye Nur, also an important wine producing valley in the past. It is inhabited by Pashai whose Indo-Aryan language is only distantly related to the idioms of the Kafirs/Nuristani, but who were certainly classified as Kafirs as well before they were gradually Islamized some time before 'our' Kafirs. See Wutt 1981, pls. 152, 153, 159.

19 The rings were called *shagere*, while *dāl* (or *dal*) denotes large poles mostly standing at pathways near the villages and signalling the number of homicides by the number of wooden plugs hammered into the trunk.

20 After the pouring of blood on the fire, the severed heads of the goats were placed briefly at the fire and their carcasses were held above it so that some of their hair would burn. All the deities were thought to cherish the smell of burned blood and hair.

to Zhönchigal, new wine was thrown on the statue, as reported to Edelberg (p. 165).<sup>21</sup> Silver cups filled with wine were probably used in this context and when feasting Indr in his temple in the winter month of Zintsei-mās. The assumption that silver cups were used at these rituals is supported by a report of such a use by the Parun Kafirs, inhabitants of the Parun Valley further to the north,<sup>22</sup> when sprinkling the statue of Wushum, one of their main deities, with the blood of sacrificed goats.

The date of the Indr festival in Indrak'un could not be ascertained, but it must have taken place soon after of the picking of the grapes, lasting four days (followed by that of walnuts, pomegranates and jujubes), starting on the first of the September/October month of Drashletr-mās. The most likely date is the end or the last day of this month, when all the flocks, mainly of goats, and their goatherds had returned to the village. The feast must have been particularly merry, with singing and dancing exceeding that of all other feasts, and with some excessive wine-related behaviour with regard to the sexual relations, in particular between the unmarried young. A similar, but probably smaller feast, recorded by both Edelberg and the present author, took place about the same time in Zhönchigal in honour of the local guardian deity Traskan (1965, p. 175). His name also appears in that of the local grape- and fruit-picking month called Traskando-mās, which is mostly known in Waigal Valley under the name of Atau-mās. In default of stone vats, in Zhönchigal, as in all other wine-producing villages, except in Wama, the vinification took place in large wooden pots or stone vessels. The wine was then stored in wooden pots or stone vessels or skin-bags.<sup>23</sup> Until it was drunk out of wooden vessels or the rare silver cups owned by a small minority of important and/or wealthy men.

On the occasion of feasts, in particular the often very elaborate feasts of honourification, better known as 'feasts of merit', which could include invitations not only to the eligible population of the host's community, but also to that of neighbouring villages, the respective host had to care especially for the wealthy and established guests by serving them food and wine

21 The author could not verify that statement.

22 The Parun River is the eastern of the two main feeders of the Pech River. The culture of the local Kafirs, living surrounded by the Kati Kafirs to the east and west, as well as the Wama and Waigal Kafirs to the south, forms the topic of the forthcoming study by the present author, complementing that on the Waigal and Ashkun Kafirs published in 1999.

23 A story recorded by G. Buddruss in Nisheigram and published by A. Degener deals with the grape picking from privately owned vines and the vinification in stone vessels which were then sealed off with clay for three months. The wine, *čükura*, was often left to age for three to four years. Old wine, *přã*, mixed with honey, *maçi*, was the highly cherished drink *maçi-přã*. See Degener 1998, pp. 307 ff. Vines can only be privately owned when growing and climbing on trees standing on private land.





Figure 12. The *Indr-tā* cultplace in the Indrak'un garden with stone blocks as seats (photo: M. Klimburg, 1974)

inside the privacy of his house.<sup>24</sup> These celebrations may frequently have been nothing less than drinking bouts with mainly whitebeards present, each of them sitting on his proper chair-of-honour known as 'horn chair' (*ṣiṅ-neṣā* in Waigal, *ṣiṅ-asta* in Wama/Ashkungal) featuring two backrests set at a right angle (figs. 18-19). At least some of them must have owned a silver cup which they could have placed on a special stand next to their chairs – if such a stand called *urei-taò* was in their possession (figs. 17-18).

An additional, specifically honorific role of these large, stemmed, chalice-like silver cups or goblets, known as *urei* and *ro* (silver) in Waigal, in Wama and Ashkungal respectively (figs. 13-16, 18), was reported in the context of funeral feasts in honour of important men. Then a wooden cruciform structure dressed with a woman's shirt and capped by a reversed *urei* or *ro* (in so far as the deceased had owned a silver cup) was carried in dance (see Klimburg 1999, p. 98). Such an object, known in Waigal as

24 Robertson mentioned wine drinking at a public feast only once, stating that there was much dancing also with a heavy wooden ancestor figure, *mute* (1896, pp. 219 ff.). It was a large, expensive feast in the context of the ancestor cult, as such a figure then served for some time, placed near the cemetery and next to those of other ancestors, to remind everybody of the respective important person who had died in the year before that feast.



Figure 13. The two silver cups *urei* shown to Edelberg, 1955 (Edelberg 1965, fig. 4)

*dal-sanka*, represented the dead, and it recalls the dancing with wooden ancestor figures in Kamdesh observed by Robertson. All this expressed great respect for the dead person's social merits, especially those honoured for the killing of genuine or imagined enemies, strongly indicated by the use of an *urei* as a shining 'helmet', which served otherwise as a wine-drinking vessel and, probably, also as a blood-filled sacrificial vessel. Ancestor figures did not exist among the Waigal and Ashkungal Kafirs, and hence such dressed and helmeted cruciform structures might be understood as a local and specifically also blood cult- and achievement-related status object reflecting somewhat the highly developed ancestor cult with its figures of the Kati Kafirs, demonstrating the preservation of higher social standing more than particular deeds and achievements.

The cups were no particular status objects such as the chairs-of-honour (figs. 18-19), carved decorations on the facades and posts of the houses, insignia and the like, all based on meritorious deeds. They represented rather the status of wealth, being valued in the 1970s as the equivalent of



Figure 14. Two informants with an *urei* in Nisheigram, Waigal Valley (photo: M. Klimburg, 1976)



Figure 15. *Urei* from Nisheigram (Waigal), h. 18 cm, Ø 21 cm, donated to the Kabul Museum (see Klimburg 1981, fig. 48), lost (photo: M. Klimburg, 1978)





Figure 16. Stemless *urei* in the Victoria and Albert Museum, London (Carter 1992, fig. 11)



Figure 17. Cup-stand *urei-taò* from Zhönchigal (Waigal Valley) donated to the National Museum of Afghanistan (see Klimburg 1981, fig. 45) (photo: M. Klimburg, 1978)

30-60 goats,<sup>25</sup> and that of connections to the world of spirits, *peri*, or even deities credited with help in raising fertility and gaining wealth. Stories tell of silver or even golden cups in treasures hidden in small lakes high up in the mountains, whose water would have retreated on certain occasions and then exposed the glittering objects.<sup>26</sup> Certain *urei* were said to have had the capacity of ringing when touched by lower class, ritually impure people like the *bari* and *shüwala*, and to heal infertile women when touched by them. Spirits are believed to have produced them according to information given in the 1960s and 1970s mainly in Waigal. There was the tale of a secret smith named Gauwarkawana living somewhere on the southern border of Kafiristan towards the Pech Valley who would produce and magically deliver *urei* as well as the special Kafir daggers known as *katara* (fig. 20, recalling the ancient Greeks' *akinakes*). If someone wished to order such an object, he had to request the local shaman (in Waigali:

25 A female goat aged 2-3 years was/is the basic unit of value at any transaction in southern Kafiristan/Nuristan.

26 See Jones 1973-1974 and Klimburg 1999, pp. 214 ff. Jones' statement that some of the *urei* could be worth «as much as 240 goats» or «the price of a man» (p. 170) cannot be taken seriously.





Figure 18. Three-legged iron stand with added-on *urei*-stand next to a chair of honour in the Moesgård Museum in Denmark (photo: M. Klimburg)



Figure 19. Chair-of-honour *şiq-neşä* in Nisheigram (Waigal Valley), donated to the National Museum of Afghanistan (see Klimburg 1981, fig. 19) (photo: M. Klimburg 1972)



Figure 20. Kafir dagger *katara*

*dyäl*) to contact the smith, bring 30-60 goats or 4-8 cows for an *urei* and 6-7 goats or one cow for a *katara* to a certain location and then leave. The animals, after having been checked and approved as payment, then disappeared, and several days afterwards the *dyäl* would have informed the purchaser that the paid-for *urei* or *katara* would be seen placed at the same spot or even suspended in the air waiting to be fetched. Such tales may have been created some time ago for socio-political purposes.

More trustworthy sounding information given in Parun, once the religious centre of Kafiristan,<sup>27</sup> claim that the cups were made in Badakhshan and then exported to Kafiristan, together with much coveted, gaudy looking *ikat* clothes and coats from Middle Asia as well as much needed salt. Such an origin appears possible, but the question remains as to their relations to the very similar looking drinking vessels depicted in ancient wall-paintings of the sixth to eight century CE in Sogdian Middle Asia such as in Balalyk Tepe (Albaum 1960, fig. 109). Jettmar hypothesized that they were popular in «the ruling class of the nomadic warriors in the steppes» of Tokharistan (Middle Asia) and were «exported to the ceremonial use of a nobility of Hephthalite descent ruling in Gandhara. They were copied by the common people and were finally brought to the mountains» of Kafiristan (1973b, p. 42), where, of course, the remarkably capable *bari* craftsmen of the Kafirs could have copied them.<sup>28</sup>

Evidently, both the wine and the silver cups had important social and probably also religious functions which, unfortunately, are hard to envision with any degree of reliability. The cups may well have played the role also of sacrificial chalices used in religious cults to promote fertility.<sup>29</sup> In addition, the red wine, which was/is the general kind of wine produced in Kafiristan, may have been seen as reflecting the blood of sacrificial animals. As already reported with reference to the cult of Indr in Wama, wine was drunk there also or mainly in honour of Indr, who was believed to be a great wine drinker himself, whose effigy was allegedly splattered with wine and whose temple reportedly served also as a community wine storage. Likewise, wine was drunk during feasts honouring local tutelary deities such as Traskan, the protector of both Waigal Village and Zhönchi-

27 The Parun Valley constitutes the heart of Kafiristan/Nuristan, where (by far) the largest Kafir temple once stood. Since some twelve years it houses the capital of the province of Nuristan. Through the valley leads an important path connecting central Nuristan with Badakhshan, the province and historical landscape to the north of the Hindu Kush.

28 Proving their craftsmanship, the Kafirs' blacksmiths among the *bari* craftsmen produced very antique-looking three-legged stands of wrought iron, often decorated artistically, which served to hold flat wooden bowls or, designed differently, silver cups (figs. 17-18).

29 There was not much of a role left for them after Islamization, and therefore they were then used to help paying the (always somewhat negotiable) bride price once set at 200 goats and often even more, e.g. in the Waigal Valley.

gal, or Gröshter-panao, the guardian deity of Nisheigram, or, above all, Indr, the tutelary 'wine god' of Wama and also of Nakara (Titin Valley in Ashkungal). Accordingly, wine must have had a (regionally varied) cultic value in all of 'greater Kafiristan', recently proposed as 'Peristan' (see Caccopardo, Caccopardo 2001), as also indicated in the information gathered in the 1960s by K. Jettmar among Ismaelis in Punyal (North-Pakistan), where during the pressing of the grapes, preferably by boys or young men, one had to observe strict purifying traditions meant to preserve the wine's cultic purity.<sup>30</sup>

One may surmise that the worship of village tutelary deities in comparatively wine-rich southern and southwestern Kafiristan had particular wine-related features including the use of silver cups as sacrificial vessels to express special reverence to the deities. Accordingly, there was probably more emphasis on the cultic role of wine in southern Kafiristan than in the Bashgal Valley, not so speak of the wine-less Parun Valley, where wine was available only in smaller quantities and therefore drunk primarily in the context of private and public feasting. However, during invocations of deities not only sacrificial blood but also some wine could be thrown on their shrines or effigies, as was the case at a rite attended by Robertson in honour of the war deity Gish/Giwish. Before the sacrifice of 15 male goats the door of the deity's shrine was sprinkled with wine, water, ghee and millet flour scooped out of four wooden bowls - in essence an offer of *hors d'œuvre* before the main dish consisting of 15 sacrificed male goats (1896, p. 429).<sup>31</sup>

The basic differences assumed here in the viticulture of the Kati/Kam Kafirs versus the Waigal/Ashkun Kafirs indicate more emphasis on more private and public enjoyment in the east versus accretional cultic values in the south and south-west of Kafiristan and would complement the numerous other socio-cultural features which allow to discern between two distinct Kafir cultures. Differences in the achievement orientation may be credited for many of these variations, and thus it is plausible that the wine culture in the highly competitive Waigal/Wama/Ashkungal culture had pre-

---

30 Jettmar 1973a, pp. 192-3 and 198-9: A young man had to wash his feet and then, before the treading of the grapes, he and the others present were purified with the smoke of burning juniper. At another place the treading of the grapes was done by boys (of untold age) after they had taken a bath, put on new clothes and had been purified by the smoke of burning juniper, as were the attendants and the press, and after finally a certain dish was ritually eaten to please the wine-loving *peri* (fairies), who were believed to be present at the pressing. Women of child-bearing age were not allowed to attend. An animal (goat?) was sacrificed after the pressing.

31 After having filled four wooden vessels with wine, water, millet flour and ghee, the priest Utah took «a small quantity of the contents of each vessel [and] threw it against the small closed door of the shrine, all the time repeating a certain invocation [...] The goats were then rapidly seized» and killed.

served at least some of its former cultic values, including that of the silver cups, shared by the whole (eligible) male population. In contrast, among the Kati speakers in the east, primarily in Kamdesh, a more firmly stratified society had made wine drinking a privilege of the wealthy, who appear to have contented themselves with the less ceremonious use of every-day wooden cups as drinking vessels. Thus also the two different types of wine-drinking vessels appear to reflect – among numerous other features – two diverging cultures with different socio-cultural backgrounds.

The millennia-old traditions of Indo-Iranian wine-related life-styles in isolated mountain societies in the Hindu Kush, nearly extinguished by the Islamization of the Kafirs of the Hindu Kush, have survived among the numerically much inferior Kalasha Kafirs in Chitral, Northwestern Pakistan. It is in Birir, the southernmost of the three valleys inhabited by those Kafirs in the southwest of the Chitral district, a valley particularly rich in wild growing vines, that the Kafir viticulture still enjoys its great traditional values attached to wine as a highly esteemed, nearly cultic beverage.<sup>32</sup> It is praised for its «inherent purity revealed by the gods for prayer and rejoicing» (Loude, Lièvre 1988, p. 68), with ritual ‘pure’, called *onjesta*, versus ‘impure’, called *pragata* (the basic Kafir classification of everybody and everything).

The picking of grapes (and other fruits), strictly forbidden before,<sup>33</sup> starts in late September (on 20th in 2006) or in the beginning of October, after an evening sacrifice in honour of the deity Praba, a god closely associated to the Indian deity Indra/Indr and also seen as a protector of the vines and the health of the Kafirs. Two goat kids – one for each of the valley’s two moieties – are killed at each of the two adjoining cult places of Praba, with the moieties alternating in providing the sacrificial animals and using these places. The first sacrifice is at the smaller cult place consisting only of a «roundish whitish stone» (Di Carlo 2007, p. 54), the second at the god’s shrine, which features an altar topped by two wooden horse heads. In both cases an *onjesta* virgin boy kills the animals next to a sacrificial fire and sprinkles the kids’ blood on the fire – a standard sacrificial procedure. Then, at the first offer, he also throws blood on the faces of the participants, thereby initiating them to the second, more

32 Good descriptions are only by Loude and Lièvre (1987, based on a visit in 1985) and Di Carlo (2007, based on a visit in 2006), while Staley’s report is very short and the information given in the recent book by Fentz is partially doubtful.

I am very grateful to A.S. Cacopardo for informing me about that wine culture, which I had not noticed adequately before, and for commenting critically my respective discourse.

33 As already noted above, in the Kafir – and still in the Nuristani – social economy, all the starts of harvesting crops and collecting fruits are strictly regulated by each village, which therefore chooses annually a certain number of men empowered to control and fine trespassers.

important sacrifice (p. 54),<sup>34</sup> when the boy also sprinkles blood on the altar and – according to Loude and Lièvre (1988, p. 68) – on bunches of freshly picked grapes. Then the first animal’s meat is cooked and eaten while the second kid’s «meat is roasted and eaten by the *onjesta suda* ‘pure boys’, and its bones are then thrown into the fire» (Di Carlo 2007, p. 55). This last act cannot but mean that the whole animal is offered to the deity, as a similar observation was made 21 years earlier by Loude and Lièvre (1987, p. 209). The two French researchers observed a virgin boy killing the first of two goat kids at the Praba shrine (the smaller cult place is not mentioned), then grilling and eating pieces of the kid’s meat and throwing the whole carcass into the fire as a special offer to Praba. This gift of the goat’s whole body to the deity was explained as necessary «to re-establish the threatened purity» endangered by the conversion to Islam of members of the Kafir community some time before. The French researchers noticed further that the meat of the second sacrificed kid was then boiled and eaten at the shrine, and that the participants at the sacrifice were also offered, as the valley’s privileged first persons, fruits (grapes, walnuts, pears) picked before the general fruit harvesting was allowed to start in the following morning.<sup>35</sup>

After this sacrifice the general picking of the grapes starts, undertaken by men and boys climbing the trees and collecting the grapes in small baskets which are then emptied by women below the trees into large carrying baskets. Men carry these baskets to the (still empty) winter stables.

The pressing of the grapes not eaten fresh or separated for making raisins (described by Di Carlo 2007, pp. 55 f. and Fentz 2010, pp. 404 f.) then takes place next to sheds close to the stables. A deity by the name of Warin, also associated to the god Indra/Indr, is invoked to provide for a good wine quality, and virgin boys, occasionally also men, ritually purified for the occasion, squeeze with their feet the grapes heaped in large boxes (up to 3 m long, nearly 1 m wide and up to 1 m high), which are dismantled after use (figs. 21-22). The juice is led through a hole and a conduit into big plastic bins or – hardly seen any longer – stone vessels kept in the ground or pits

---

34 According to Fentz (2010, p. 393), the boy dips his head into the blood. This feature has been documented by others only in the context of the Chaumos feast.

35 In Fentz’ description (2010, pp. 393 ff.) special wine made of grapes picked before in «a sacred protected area in the lower part of the valley» was drunk «during the sacrificing at the Praba shrine». Then, in a nearby winter stable, when the participants ate the (roasted or boiled?) meat of the sacrificed kid, clusters of grapes were brought in, «one for each man [...] Finally, each man receives a large cup of wine». However, no other researcher has reported anything like that, and thus the very interesting information of an early sacred wine and the wine drinking at the Praba shrine may be just a story told by Kafir informants with a bent to extemporize. Furthermore, no non-Kafir man, and even less so a woman, is allowed to witness that particularly *onjesta* ritual.



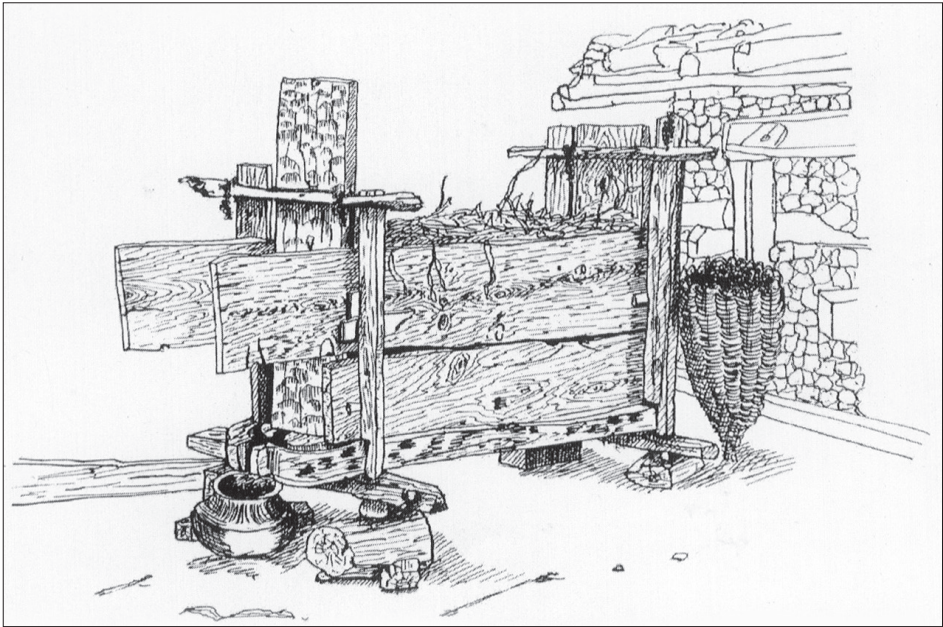

Figure 21. Wine press in Birir (Loude, Lièvre 1987, fig. 2)

in the ground carefully lined and tightened with stone slabs.<sup>36</sup> Protected by lids, the juice will become wine already after some ten days.<sup>37</sup>

The grape-skins remaining of the wine-pressing «are hand pressed with a stone. This juice is drunk separately, and the dregs from the pressing are shaped into small balls that are kept aside and eaten as a great delicacy» (Fentz 2010, p. 408).<sup>38</sup>

Drinking wine is 'authorized' only at the beginning of the winter feast Chaumos, when animals are sacrificed to honour a more martial deity by the name of Grimun. However, some of the new, still fermenting wine is drunk 'illegally' already during the Prun festival (Di Carlo 2007, p. 58), which starts - together with the harvesting of cereals - 10 to 14 days after the picking of the grapes and their pressing to juice.

<sup>36</sup> Cacopardo was told that such a pit's size «is as deep as a man is tall and as wide as his outstretched arms» (personal communication).

<sup>37</sup> According to Fentz (2010, p. 385), Birir households «cultivate [i.e. have rights to?] an average of 20 to 30 vines producing several hundred litres of wine», and some families are «able to harvest more than 1,000 bottles per year» (!). Naturally, much of it is sold to mostly Muslim visitors.

<sup>38</sup> See above the description of a similar, more technical method of 'dreg-pressing' as seen by Robertson in a hamlet near Kamdesh.



Figure 22. Wine pressing of the Kalash in Birir (Fentz 2010, fig. 356)

Prun is a Birir feast which is variously called an autumn wine or harvesting or fertility festival celebrated with much singing and dancing – actually a feature common to all Kalasha feasts. It has no particular wine connotation except in a wider sense insofar that wine stimulates and reduces inhibitions with regard to sexuality. This used to play an important role until Muslims living nearby – virtually all of them Islamized Kalasha – made the Kafirs reduce markedly all sexually relevant behaviour.<sup>39</sup>

During Chaumos, the long-lasting winter solstice festival of all the Kalasha with the focus on the ritual initiation of boys and girls, purification of men and women and the enhancement of communal solidarity, which

<sup>39</sup> Until recent times a goatherd or even several of them, just having descended from the pastures in the high mountains after a long isolation from women, appeared at the Prun festival dressed as he-goats with horns on their heads. Loaded with sexual energy, these *budalak*, as these men were called, were allowed to attack women and girl who were expected to take full advantage of the situation – for the good of progeny. See also Jettmar 1975, p. 392.



in Birir is in essence a wine festival,<sup>40</sup> much wine is consumed after its drinking has been 'authorised' by the deity Grimun. As told to A.S. Cacopardo in 2006 (2010b, pp. 150 ff.), who was not allowed to attend the rite, a sheep and a goat have to be sacrificed to that deity in the evening of the second day of the feast (on 15 December in 2006) at a goat's shed located at a distance from the deity's holy place and housing plastic bins or a pit filled with wine.

The wine consumption by both sexes and also children especially during the extensive singing and dancing can be so high that drunken behaviour, even that of women, is common, as noticed by Schomberg in the 1930s,<sup>41</sup> by Topper in the 1960s and again by A.S. Cacopardo in 2006, while participating in the Chaumos (but not allowed to attend all the rituals). This wine drinking by women appears to be in sharp contrast to basic attitudes among the Kafirs in former Kafiristan, present Nuristan – a difference simply existing or partially explicable by culture change and by the fact that hardly anywhere there the conditions for the growing of wild vines are as favourable as in Birir, resulting in a much smaller production of wine.

Accordingly, in a small Hindu Kush valley in the northwest of Pakistan the Kafir viticulture with its ritually relevant features is still alive, but its survival is certainly in danger in view of the mounting Islamist threat. Its death would mean the end of the last pre-Islamic remains in a wide region once dominated by Kafir-like beliefs and an important Buddhist culture, both spirited by wine which may have originated locally many thousand years ago on the basis of wild growing vines of a special kind whose various descendants then may well have become our vines.

My research of the Kafir cultures in Nuristan and Chitral was generously supported by the German Research Foundation (DFG) and in 1995 also by the Austrian Science Fund (FWF).

40 Personal communication by Cacopardo, who states «che l'ebbrezza da vino è un tema che percorre tutta la festa» (drunkenness of wine is a theme which is present during the whole feast) (2010b, p. 151).

41 Schomberg observed that in spite of strict local regulations of gender dichotomy «the women will drink the wine as well as the men, and some of them are even famous toppers» (1938, p. 192).

## Bibliography

- Albaum, L.I. (1960). *Balalyk-Tepe*. Tashkent.
- Babur-Nama* (1922). Trans. by A.S. Beveridge. 2 vols. London: Luzac & Co.
- Barrington, Nicholas; Kendrick, Joseph T.; Schlagintweit, Reinhard (2006). *A Passage to Nuristan: Exploring the Mysterious Afghan Hinterland*. London: I.B. Tauris.
- Burnes, Alexander (1842). *Cabool*. London: John Murray.
- Cacopardo, Alberto M.; Cacopardo, Augusto S. (1989). «The Kalasha (Pakistan) Winter Solstice Festival». *Ethnology*, 28, pp. 317-329.
- Cacopardo, Alberto M.; Cacopardo, Augusto S. (2001). *Gates of Peristan: History, Religion and Society in the Hindu Kush*. Rome: IsIAO.
- Cacopardo, Augusto S. (2008). «The Winter Solstice Festival of the Kalasha of Birir: Some Comparative Suggestions». *Acta Orientalia*, 69, pp. 77-120.
- Cacopardo, Augusto S. (2010a). «Texts from the Winter Feast of the Kalasha of Birir». *Acta Orientalia*, 71, pp. 187-242.
- Cacopardo, Augusto S. (2010b). *Natale pagano: Feste d'inverno nello Hindu Kush*. Palermo: Sellerio.
- Carter, Martha L. (1968). «Aspects of Kushan Art». *Ars Orientalis*, 7, pp. 121-146.
- Carter, Martha L. (1992). «Dionysiac Festivals and Gandharan Imagery». *Res Orientales*, 4, pp. 51-59.
- Degener, Almuth (1998). *Die Sprache von Nisheygram im afghanischen Hindukusch*. Wiesbaden: Harrassowitz.
- Di Carlo, Pierpaolo (2007). «The Prun Festival of the Birir Valley, Northern Pakistan, in 2006». *East & West*, 57, pp. 45-100.
- Edelberg, Lennart (1965). «Nuristanske Solvpokaler». *KUML*, pp. 153-201.
- Edelberg, Lennart; Jones, Schuyler (1979). *Nuristan*. Graz: Adeva.
- Elphinstone, Mountstuart (1839). *An Account of the Kingdom of Caubul*. 3rd ed. 2 vols. London: Richard Bentley.
- Faccenna, Domenico (1964). *Sculptures from the Sacred Area of Butkara I (Swat, W. Pakistan)*. Descriptive catalogue by M. Taddei. *IsMEO Reports and Memoirs*, 2 (2-3). Rome.
- Falk, H. (2009). «Making Wine in Gandhara under Buddhist Monastic Supervision». *Bulletin of the Asia Institute*, 23, pp. 65-78.
- Fentz, Mytte (2010). *The Kalasha: Mountain People of the Hindu Kush*. Humlebæk: Rhodos.
- Filigenzi, Anna (unpublished). «Non-Buddhist Customs of Buddhist People: Visual and Archaeological Evidence from North-West Pakistan». Manuscript of 23 pages.
- Ingholt, Harald (1957). *Gandharan Art in Pakistan*. New York: Pantheon books.

- Jäger, Ulf (2014). «Wine on the Northern Silk Road in Pre-Islamic Times». In: Fragner, Bert G.; Kautz, Ralph; Schwarz, Florian (eds.), *Wine Culture in Iran and Beyond*. Wien: Verlag der Österreichischen Akademie der Wissenschaften, pp. 43-51.
- Jäger, Ulf (2015). «Dionysisches in Gandhara. Zu einem bemerkenswerten Gandhararelief der Kuschzeit (ca. 2-3. Jh. AD) in der Sammlung Florence Gottet/Schweiz». *Berliner Indologische Studien*, 22, pp. 103-122.
- Jettmar, Karl (1972). «Ein nuristanischer Silberpokal im Linden-Museum». *Tribus*, 21, pp. 25-34
- Jettmar, Karl (1973a). «Weinbereitung und Weinrituale im Hindukusch». In: Tauchmann, Kurt (Hrsg.), *Festschrift zum 65. Geburtstag von Helmut Petri*, Köln; Wien: Böhlau Verlag, pp. 191-204.
- Jettmar, Karl (1973b). «Iranian Influence on the Cultures of the Hindukush». In: Jettmar, Karl; Edelberg, Lennart (eds.), *Cultures of the Hindukush: Selected Papers from the Hindu-Kush Cultural Conference held at Moesgård 1970*. Wiesbaden: Franz Steiner, pp. 39-43.
- Jettmar, Karl (1975). *Die Religionen des Hindukusch*. With contributions by Schuyler Jones and Max Klimburg. Stuttgart: Kohlhammer.
- Jettmar, Karl (1986). *The Religions of the Hindukush*, vol. 1, *The Religion of the Kafirs*. London: Aris & Phillips.
- Jones, Schuyler (1973-1974). «Dolke, Pokaler og magiske: Søer i Nuristan - Silver, Gold and Iron: Concerning Katera, Urei and the Magic Lakes of Nuristan». *KUML*, pp. 231-263.
- Jones, Schuyler (1974). *Men of Influence in Nuristan*. London: Seminar Press.
- Klimburg, Max (1981). «A Collection of Kafir Art from Nuristan: A Donation by the Federal Republic of Germany to the National Museum of Afghanistan». *Tribus*, 30, pp. 155-202.
- Klimburg, Max (1999). *The Kafirs of the Hindu Kush: Art and Society of the Waigal and Ashkun Kafirs*. 2 vols. Stuttgart: Franz Steiner.
- Klimburg, Max (2004). «The Arts and Societies of the Kafirs of the Hindu Kush». *Asian Affairs*, 35, pp. 365-386.
- Klimburg, Max (2014). «Viticulture in Kafiristan». In: Fragner, Bert G.; Kautz, Ralph; Schwarz, Florian (eds.), *Wine Culture in Iran and Beyond*. Wien: Verlag der Österreichischen Akademie der Wissenschaften, pp. 53-70; 331-339 (17 illustrations).
- Kupfer, Peter (2014). «Rethinking the History of China's Grape Wine Culture». In: Fragner, Bert G.; Kautz, Ralph; Schwarz, Florian (eds.), *Wine Culture in Iran and Beyond*. Wien: Verlag der Österreichischen Akademie der Wissenschaften, pp. 23-42.
- Loude, Jean Yves; Lièvre, Viviane (1988). *Kalash Solstice*. Islamabad: Lok Virsa. Transl. of.: *Solstice païen*. Paris: Presses de la Renaissance, 1984.
- Loude, Jean Yves; Lièvre, Viviane (1987). «Fêtes d'été chez les Kalash du Nord Pakistan: cascades de lait, vin de jambes et berger géniteur». *L'Ethnographie*, 83, pp. 191-220.

- Masson, Charles (1974). *Narrative of Various Journeys in Balochistan, Afghanistan and the Panjab*. 3 vols. Karachi: Oxford University Press.
- McGovern, Patrick E. (2014). «Iranian Wine at the 'Dawn of Viniculture'». In: Fagner, Bert G.; Kautz, Ralph; Schwarz, Florian (eds.), *Wine Culture in Iran and Beyond*. Wien: Verlag der Österreichischen Akademie der Wissenschaften, pp. 11-21.
- Morgenstierne, Georg (1961). «Dardic and Kafir Languages». *Encyclopaedia of Islam*, vol. 2. Leiden, pp. 138 ff.
- Neubauer, H.F. (1974). «Die Nuristanrebe, Herkunft der Edelrebe und Ursprung des Weinbaus». *Afghanistan Journal*, 1, pp. 32-36.
- Olivieri, Luca M. (2008). «Hanging Rocks and 'Intoxicating Drinks': The Rock Art Sequence of the Swat Valley». *South Asian Studies*, 24, pp. 15-26.
- Olivieri, Luca M. (2011). «Beyond the Buddhist Communities. Subalternity and Dominancy in Ancient Swat». *Journal of Asian Civilizations*, 34 (1), pp. 127-156.
- Raverty, Henry George (1888). *Notes on Afghánistán and parts of Balúchistán*. London: Eyre & Spottiswoode.
- Robertson, George Scott (1896). *The Kafirs of the Hindu-Kush*. London: Lawrence & Bullen.
- Scheibe, Arnold (ed.) (1937). *Deutsche im Hindukusch. Bericht der Deutschen Hindukusch-Expedition 1935 der Deutschen Forschungsgemeinschaft*. Berlin: Karl Siegismund.
- Schomberg, R.C.F. (1938). *Kafirs and Glaciers. Travels in Chitral*. London: Hopkinson.
- Snoy, Peter (1962). *Die Kafiren: Formen der Wirtschaft und geistigen Kultur* [Ph.D. thesis]. Frankfurt.
- Staley, J. (1964). «The Pool Festival of the Kalash of Birir». *Folklore*, 74, pp. 197-202.
- Topper, Uwe (1977). «Beobachtungen zur Kultur der Kalaş (Hindukusch)». *Zeitschrift für Ethnologie*, 102, pp. 116-296.
- Wutt, Karl (1981). *Pashai: Landschaft, Menschen, Architektur*. Graz: Adeva.

## **6 Identity and the Others**



## Borders

Itineraries on the Edges of Iran

edited by Stefano Pellò

# Marginalia on the Idea of Boundary and the Discourse on Identity in Iran

Biancamaria Scarcia Amoretti  
(La Sapienza Università di Roma, Italia)

**Abstract** The paper focuses on the theme of Iran and the frontier through five interconnected conceptual lenses, namely the broad notions of identity and identifications, the dyad Muslim/Persian and its relation with the third key denomination of 'Arab', the acculturative space of language, the meaningful role of the Ahl al-bayt and the Sayyids, and, finally, the meaningful polysemic place of *waṭan*, whose Western translation as 'homeland' notoriously posits several problems. More in general, a critical treatment of the all-seasons contrast between 'centre' and 'periphery' marks the whole discussion.

**Summary** 1 Identifications. – 2 Islam. – 3 Language. – 4 Elite. – 5 Homeland.

**Keywords** Frontier. Sayyids. Diaspora.

## 1 Identifications

The boldness of choosing such a monograph theme as the notion of 'boundary' becomes so much more apparent the more one wants to work, as is the case here, on a context – Iran – that is seemingly so acknowledged, as to seem to be a paradigmatic case. The fact is, this isn't actually true, except that the Iranian context is extremely difficult to define and, as such, it offers a composite spectrum of markers whose definition could provide a significant basis of comparison for other less problematic situations. In other words, Iran could be the best test case to try to define in a plausible and shared way a sort of persuasive inventory of the conceptual categories in which to place the question of the 'boundary' itself. My contribution here should be read in this light. The conceptual categories I will take into consideration here and illustrate by an example which might seem eccentric – how the sense of the presence of the descendants of the Prophet in Iran in the first centuries of Islamic rule relates to the notion of boundary – pertain to the definition of identity, with particular refer-



ence to the 'Islamic oecumene' (*dār al-islām*) and its meaning,<sup>1</sup> and to the different 'Islamic' contexts within it. Thus, they are different – albeit not necessarily in opposition – from those categories which seem to underline the descriptions of the Islamic oecumene and the different Islamic contexts given by the interested parties, for example the geographers.<sup>2</sup>

For a general view of the 'identity' question, I refer to the complex and articulate «Iranian Identity» entry of the *Encyclopaedia Iranica*, entrusted to several authors and with a rich bibliography, whose chronological arrangement I would like to underscore: 1) Perspectives on Iranian identity; 2) Pre-Islamic period; 3) Medieval Islamic Period; 4) In the nineteenth and twentieth centuries; 5) In the post-revolutionary (Ashraf et al. 2006).<sup>3</sup>

Methodologically, as far as my example goes, I refer to Jan Assman's theory, as it is summarized in the *Introductory Speech* by the former President of the Societas Iranologica Europaea Maria Macuch to a collective book devoted to the *Iranian Identity in the Course of History* (Cereti 2010). In his renowned work on 'cultural memory' Assmann «has suggested a theoretical division of 'identity' into three categories of (1) 'individual', (2) 'personal' and (3) 'collective' identity», where the first category «denotes the conscious image a person has built of himself»; the second one «denotes the sum of all the roles, characteristics and competences assigned to a person in the specific social context of the community he or she lives in, determining the status and social standing of the individual in the community»; and the third one «is the image a group of people has of itself» as the result «of the identification on the part of the involved individuals, since it does not exist *per se*, but only at the extent certain persons are willing to commit themselves to it» (p. 2). Regarding the second category, it seems to me even more necessary to quote some passages by Brauer (1995) that, on the one hand, best express what underlies my analysis and, on the other, are relevant to our discourse as they are «observations based on data from Arab-Iranian Societies» (p. 66).

While translating al-Idrīsī's *Book of Roger...* his great 'Opus geographicum', I failed to encounter any references to boundaries between various political or ethnographic units in either the text of this work or the maps accompanying it. In view of the importance of boundary concepts,

1 For an example of how this expression is fluid and not at all obvious, see Calasso 2010.

2 On the ambiguity of the various adjectives used to define what is 'Muslim' and what is 'Islamic', and on the advisability, at least among scholars, to agree on it, see the *Preface* by Babayan in Babayan, Najmabadi 2008, a relatively recent text that, among other things, deals also with the notion of 'boundaries' in the context of sexuality. Babayan (p. IX) refers there to the opinion and the proposal made in an epoch-making work by the well-known Islamist M.G.S. Hodgson (1974).

3 For the post-revolutionary period, the entry refers to the online Supplement.

this observation seemed worthy of further enquiry to determine whether it may represent an idiosyncrasy of this one author or prove to be a reflection of a more general characteristic of the geography concepts current in the Arab-Islamic civilization.

Al-Idrīsī's work was written in 1154. In subsequent passages, Bauer proposes a comparison with the older *Kitāb ṣūrat al-'arḍ* by al-Khwārizmī (vixit ninth century), which also «did not include information on boundaries» (p. 1 ff.). According to Bauer, that influenced cartography to such an extent that «examination of maps by twenty-three Arabic-islamic geographers working between 820 and 1350 AD shows that boundaries are completely omitted for much of the cartography of the period, and are represented only by simple geometric lines having symbolic rather than geographic significance... The data suggest that each country was conceived of as being divide into a core including its centre of power and a periphery separating that core from the nearest adjacent country» (pp. 6-7). Leaving aside the many technical remarks one finds in Brauer's work, despite their relevance (as, for example, the unresolved question of the *amān* as a safe-conduct), it must be pointed out that the existence of a conflict in progress between two adjacent Muslim countries could involve some emphasis on boundaries - which instead are clearly drawn between the peripheral regions of the empire and the countries outside the *umma* (pp. 8, 11, 16). In conclusion, Brauer's work confirms two points considered to be particularly indicative of the medieval Islamic world: the urban framework, which values greatly the centre(s) as an aggregating element of the *dār al-islām* («Muslim geography of the Middle Ages is a linear geography, conceived in terms of a network of lines of communication between cities», p. 13); and a *dār al-islām* which in turn is understood as an expression of an *umma* without inner boundaries, as it is logical if, as the same Brauer reminds us (p. 40), one can regard as truthful the following words of al-Māwardī (died 1058): «only where the Islamic lands are divided by a sea, the territory of *dār al-islām* [...] can be conceived of as divided in two or more political communities, the rulers of which are independent of each other, though they owe ultimately subservience to the Imām».<sup>4</sup>

In the face of their apparent irrelevance, the congruence with the

4 Note that the Moslems, in the Ottoman period, adopted the traditional categories that were used in their Empire to define the *millet*s - communities identified on the basis of their religion as a primary identity factor, without being necessarily linked to a specific territory - also in relation to the Christian world. It is worthwhile to recall how the Sultans began their letters to Elizabeth I of England: «Glory of the virtuous ladies of the Christian Community, Elder of the reverend matrons of the Sect of Jesus, Moderator of the peoples of the Nazarene Faith, who draws the trains of majesty and reverence, Mistress of the token of grandeur and glory, Queen of the *vilāyet* of England, may her end be happy» (quoted in Lewis 1988, p. 39).

themes underlying the concept of ‘boundary’ of the example chosen as a ‘marker’ is more than plausible. The *Ahl al-Bayt*, the People of the House, the Family par excellence, lends itself especially well to illustrating the paradigm of the three diverse *and* convergent identities postulated by Assmann. The expression *Ahl al-Bayt* can be interpreted in a more or less inclusive manner. The descendants of Alī, cousin and son-in-law of Muhammad – since he is the husband of Fāṭima, the daughter of the prophet – are *Ahl al-Bayt*; still, the category can also include all the descendants of Abū Ṭalib, uncle of Muḥammad and father of ‘Alī, and in some cases even the ‘Abbasids. Though for my discourse the implications of one or the other meaning are not contradictory (cf. Bernheimer 2012), here the reference concerns in particular the descendants of ‘Alī and of Fāṭima, the Ḥasanid and Ḥusaynid branches of Alids. These two branches are significant for their political and religious visibility.

For example, Shiite Imams – both the Twelvers and the Ismā‘īlites – are Ḥusaynid starting with the third one; the dynasties which ruled in the Ṭabaristān region between the ninth and tenth century were Ḥasanid. In any case, the awareness (*individual identity*) of each individual belonging to the Family is generalizable, especially if he can prove to ‘be part’ of the Family with a credible family tree, and can demand special treatment (cf. Morimoto 2003). The fact that the presence of a member of the Family in a particular place ennobles the place itself, involves a *personal identity* (bearing witness to the persistence over time of such awareness and the related prestige [cf. Elaouani Cherif 1999]). Finally, the belief on the part of the Family that they constitute a distinct social group despite it being distributed throughout the entire Islamic oecumene, establishes a *collective identity* upon which the claim of exceptionality referred to above can be based.<sup>5</sup>

This last information becomes particularly relevant in the face of a diaspora of exceptional breadth, which practically begins with Islam itself and does not stop: a diaspora which marks its territory in identity terms and, in a broader sense, becomes the essential foundation of the sense of belonging to the community of the believers – the *ummat al-islām* – in each Muslim, regardless of the place where he lives, the language he speaks and its social class. In other words, one of the many possible examples of the lack of interest in marking boundaries in a ‘geographic’ sense (as highlighted in the passage by Brauer mentioned before), favouring instead, as a defining criterion of *dār al-islām*, a boundary which is conceptually

5 In this regard, an important telling example is the *cultuality* which has the Family as its object. In fact, a specific devotion towards its members is transversal over time and spread in the entire Islamic oecumene, as demonstrated in Feener, Formichi (2016); the book includes a sort of *summary* of the question by the writer (*Shī‘a Devotion to the Ahl al-Bayt in Historical Perspective*).

dependent on the presence of Islam, not only as a religion but as a 'global system' that has as its strength, beyond just visibility, in the application of the Islamic law to which all the members of the community are subject, non-Moslems included. This helps to understand, in its primary acceptance, the meaning of the «ultimately subservience to the Imām» postulated by al-Māwardī as a basic criterion to establish where and how an Islamic instance of an institutional nature could mark, as *umma/dār al-islām*, the territory where it lives. Hence the importance that the presence of the Family assumes as a hold on which a peculiar idea of boundary can be developed – an elastic boundary, since it also depends, though not exclusively, on the mobility of the members of the Family. In fact, insofar as it is considered an 'institution' on the basis of the authority which comes from the blood tie with the Prophet, each of its members is invested with a representativeness that marks in an Islamic sense the place where he lives. This is a first, fundamental aspect of a possible manner in which to face the question of 'boundaries' in the Islamic oecumene, as long as it is considered to be a coherent cultural and institutional unit based in and from time to time represented by a given territory, whose boundaries are not based on an objective, unmodifiable fact, as a large river, the sea or a mountain range could be.

The diaspora of the Family, at least in my understanding, is not equivalent to a *hijra*. Despite what has been just said, such a diaspora does not have direct missionary goals in itself, even when the qualitative leap – in religious terms – of a certain group depends on one of its members. Besides, it is important to note that the Family is not internally homogeneous on a socio-economic level. On the contrary, hagiographic narratives on the economic difficulties of this or that member are quite widespread. Nonetheless, the presence or absence of a Family member in a given place affects its foundation, creating or highlighting an identity element that distinguishes that place from one which is 'adjacent'; and all this, as has been said before, in the name of diverse categories which are cultural rather than 'geographical', even if necessarily working in and on a given territory. Taking into account what has so far been said, we can attempt to see how the case of Iran in the first centuries of Islamic rule is an example of a process which to a large degree still persists.<sup>6</sup>

6 It is not by chance that today the Family, especially the Ḥusaynid branch, is creating a significant cultural presence outside the Islamic countries where there are important Muslim communities – as for example is the case with London – as well as in world hegemonic centres such as New York, as to demonstrate that it has the necessary requirements to co-manage such a hegemony (Mauriello 2011).

## 2 Islam

The Iranian plateau enters very quickly into the 'Islamic system'. It is a land of Arabic settlements (according to some evidence, the city of Qum was founded anew on Sasanian ruins, and in any case revived both by the Banū Ash'arī Shiite Arabs who came from Kūfa around 712 [cf. Calmard 1980] and by the Arab presence which will play a determining role in the success of the 'Abbasid *da'wa* in Khorāsān [cf. Shaban 1970]), and a passageway to the regions of Central Asia and India as well (Scarcia Amoretti 2006). There are two markers to refer to here: language<sup>7</sup> and confessional belonging, the latter with particular regard to the weight to be assigned to the idea of belonging or not belonging to a minority form of Islam. The reference here is to Shia Islam which, as mentioned above, gives a specific centrality to Alid ancestry both in political and religious terms.

In the history of Islamic conquests, Iran is peculiar for two reasons: first of all, the failed mass Arabisation as compared to what would have happened over the course of a few decades in the Near Eastern area after the Arab conquest and, most notably, in North Africa, which had remained untouched by the trade nomadism of the Arab tribes of the Peninsula; secondly, the seemingly contradictory and similarly macroscopic phenomenon that sees the Persians as protagonists in the beginning of that extraordinary cultural blossoming which characterizes the first century of Abbasid rule in particular - a blossoming that expresses itself in Arabic. Here are two emblematic examples. One of the first and most famous grammarians of the Arabic language, Sibawayhi, was born in the surroundings of Shīrāz and, after a long stay in Baṣra, returned to Fārs, where he died in 796. The choice of Baṣra is indicative in itself, since it was there, and not in Kūfa, that «the Arab and non-Arab population formed a common social structure..., drawing together the conquerors and the conquered», as the result of a «common experience under Sassanid rule» (Wilkinson 1982, p. 129). The second example is represented by the most authoritative Ab-

7 It is not news that one of the most explicit identity factors, at least in the modern world, also connoting a territory, is the *language* as a special marker. Think of the paradigmatic case of the 'Arab world' where, between nineteenth and twentieth century, when - both in the Maghreb and in the Mashreq - there was a desire to embody the concept of 'Arab Nation' and language was pleaded as a founding element: only the one who speaks Arabic is Arab. In fact, all the intelligentsias cultivated the learned Arabic - not the spoken language, the so-called dialects -, and it is this Arabic that the theoreticians of nationalism refer to. In any case, the elites internalized this idea to the extent that in relatively short times this learned Arabic became the so-called 'standard Arabic' which has effectively succeeded in its identifying function. Today, the convention that establishes the definition of the 'Arab World' (or, if one prefers, its boundaries) as the Arab-speaking countries of the Near East and of the southern shore of the Mediterranean, is a given.

basid historian, al-Ṭabarī (839-923), who was born at Āmul, in Ṭabaristān, and at only seventeen years of age began his cultural adventure between Baghdad, Baṣra and Kūfa.

Now, what answer would our two authors have given to the question: How do you define yourself? Persian? Muslim? Or what else? If the answer had been 'Persian', that would have meant that the author gave his 'mother tongue' a primary identifying value, while if he had chosen 'Muslim', the religion intended as *dīn wa dawla* would have prevailed. But the latter answer probably would not have been considered as an alternative to the former. The extraordinary element is that the question of the status to be attributed to the language – Arabic and Persian, in this case – was very much popular in the intelligentsia of the period, in a sort of literary dispute which goes under the name of *shu'ūbīya*. We are between the ninth and the tenth century and the *querelle* that has its centre in the Iraqi cities of Baṣra and Baghdad will continue, with decreasing intensity, until the twelfth century. Between the ninth and the tenth century the great Persian literary production is still making its first steps. The crux of the problem lies here in the status of the Arabs and non-Arabs (*a'jamī*), the latter being in fact Persians. The starting point is the following Koran verse (49:18): «People, We created you all from a single man and a single woman, and made you into races (*shu'ūb*) and tribes (*qabā'il*) so that you should recognize one another. In God's eyes, the most honoured of you are the ones most mindful of Him: God is all knowing, all aware» (Haleem 2004, p. 339). Depending on the interpretation of the verse, a hierarchy between *shu'ūb* and *qabā'il* could be implied: a hierarchy that, at least in the beginning, does not concern geographical but rather in cultural terms, and more precisely the status to be attributed to Arabic and Persian. Referring to an encyclopaedia entry for a comprehensive close examination of the question and how it evolved over time (see, as a starting point, Enderwitz 1997), it should be noted that the problem of territoriality of Persian claims is given when there are no more political or hegemonic implications, namely when, «as the Iranian and Arab worlds drew apart, and the Arab and non-Arab ruling classes in Iran became one, the *shu'ūbīya* controversy no longer had any reason to exist» (Mottahedeh 1976, p. 181). The author of this observation comes full circle with a reference to an ambiguous concept which is anything but taken for granted (as is easy to verify by reading section I and II of the already mentioned entry in the *Encyclopaedia Iranica* [Ashraf et al. 2006, pp. 501-507]): that of *Irān-zamīn* as an identity marker territorially understood, to which the sovereigns in this or that region of Iran may have referred to assert their actual independence even despite their formal submission to the caliph, who resided in Baghdad. Nonetheless, if it is true that, as Mottahedeh maintains, no possible comparison can be made between the concept in question and the national idea developed in Europe starting in the sixteenth century, we cannot exclude that «Iranians

of the early Islamic period had a dynastic and territorial understanding of the relation of political power to group feeling», nor that «the power of the government was mediated through an elite of local administrators and men of influence whose group identification was territorial and cultural» (p. 182). We will resume the question of the relationship between 'territorial' and 'cultural' in relation to the *Ahl al-Bayt* in Iran further on.

### 3 Language

The importance of the 'language' as an identity factor, as it relates to the impact of the Alid diaspora in Iran (and elsewhere), requires some clarification. In a work devoted to the linguistic factor, Alessandro Bausani maintained that, unlike Christianity (a difference which is by the way debatable, at least in some cases), Islam spread – and keeps spreading – starting from the top, in a process that envisioned the acculturation of the elites which then became a model for the lower classes to follow (Bausani 1981). The first element of such an acculturation was – and still is today – the learning and the resulting mastery of Arabic, whose hegemony over other languages, as is known, is first of all based on the fact that it is the 'language of God' and as such 'exceptional' in itself, besides its use by the powers in charge as the 'language of the state'.<sup>8</sup> Based on these premises, the imperial, cosmopolitan and multilingual vocation of Islamised societies finds space and meaning and, at the same time, the role of Arabic as a primary element in the common feeling of belonging to the 'Islamic system' which has been mentioned. In other words, Arabic as a marker of a boundary between an 'inside' and an 'outside'; and an 'inside' which, in its turn, is

8 In any case, one should not forget that in Central Asia (Turkestan) and in the 'modern' Ottoman, Moghul and Safavid empires, born starting in the late fifteenth century, there was a real trilingualism: the local language(s), Persian as the literary and publishing language (as today is the case with English), and Arabic as the language of religion and of law. Only much later local languages would have been attributed any identity value of a national nature. To be more precise: the privileged role and position of Persian in the *belles-lettres* of the entire non-Arab Muslim world is indisputable and undisputed (the same could be said for the influence of Iranism on the Turkicised Arab world, unmistakable as far as figurative arts go, but still to be explored in literary aesthetics). Having said that, Persian played a very particular cultural role in that world. In Central Asia, already a great sounding board and background for Iranism in itself, it functioned as a constant and indispensable – and gradually Turkicised – mediator between popular and dominant culture (which obviously was Arabo-Islamic). This is not substantially different from what happened between Persian speakers, who use this language as a vehicle of antiquarian popularization; one must only think of the revised and Iranised translation of the *Ta'rikh* by al-Tabari attributed to Bal'ami around 963. In India, in a more complex and problematic context, Persian became a true cultural 'deuteragonist'. Conversely, as for what happens in areas in which Arabic does not confront rival languages of similar weight, one can think of the paradigmatic case of Sub-Saharan Africa (see Zappa 2004).



the expression of different level of citizenship, depending on the mastery of the Arabic itself – a citizenship, however, that, at least in the first centuries of Muslim history, is always and reasonably ascribed to the members of the Family. That is to say that all the members of the *Ahl al-Bayt*, not only but *also* because they were Arab speakers, could aspire to be automatically considered elite, at least at the beginnings of the diaspora movement. What is certain on the one hand is the fact that, in the land of Iran, Arabic remained over time the language of the written production of theological, philosophical, scientific, and genealogical works – the latter especially when the Alids are in question –, despite the fact that there are influential authors such as Avicenna (d. 1037) and al-Ghazālī (d. 1111), who, though in some of their minor works, make some concessions to Persian.

#### 4 Elite

Some remarks should be added on the definition of elite when we are dealing with the *Ahl al-Bayt*. Social background and, to a lesser degree, religious belonging (Shiites versus Sunni, where it occurs),<sup>9</sup> are presented as secondary compared to the genealogical element. Not by chance, where there is an acknowledged, continuous presence of Alids, the local community is so to speak under their protection and, in case of emergency or danger, it will be them who will represent its needs to the governing power or to an ‘external’ enemy, and demand that these needs be satisfied. Otherwise, they would be regarded as evading a religious duty.

In this respect, the case analysed by Aubin (1956) regarding fifteenth-century Bam is exemplary. The protagonists are two Shiite *Sayyids* who intervene on behalf of the mostly Sunni population against the abuses of Timurid rule. The reigning prince gives in before the authority of the descendant of the Prophet in terms both of concessions of fiscal control over the territory and of the rules concerning the interpretation of the rights to spoils of war by the winner. In fact, thanks to their authority, the two *Sayyids* are able to obtain what was lost on the field. But their prestige goes beyond both the material benefits which they can obtain and their actual exercise of power in terms of the already mentioned territorial control.<sup>10</sup>

9 On the modes of ‘cataloguing’ between ethnic groups, languages, religious faiths and the like, see Scarcia Amoretti 2005 and the literature there cited. It is also to be noted that the gap between an often disappointing reality and the *topoi* that idealize the members of the Family continue to mark its history in a contradictory manner. For example, the fact of the existence of inappropriate behaviours is not denied, though their congenital ‘superiority’ is unlikely to be questioned (cf. Knys 1999).

10 Note that Aubin’s work, based on primary sources, also offers an interesting overview of the *topoi* mentioned in the previous footnote.

Generally speaking, the function of the religious factor appears to be more linear than that of the linguistic factor, especially in the case of Iran. What is interesting here are the places and manners of spreading of Shia Islam throughout the country, where – it must be underscored – it would have been a minority until the late sixteenth century, though always with constant visibility. The incorrect idea that Iran has always been a ‘Shiite country’ and consequently distinct from the adjacent Arab-speaking countries, depends on such a visibility. As is well known, though, the epicentre of the spread of Shia Islam is in lower Iraq, a region which in any case has been linked with Iran since antiquity regardless of the religious factor.

The Shiite presence in a Muslim Iran – which, as I said, was mostly Sunni until the sixteenth century – is interesting here because it exemplifies the formation of a type of an inner boundary within homogeneous entities that subsume it. There are two manifest cases: Qum and Ṭūs, two different islands both belonging to the minority Shia Islam. Their exceptionality is connected to an important marker: Muslim Qum was founded by a Shiite Arab tribe, but the marker comes from the fact that the city hosts the sanctuary of Fāṭima, one of the sisters of the eighth Imām, died in Qum in 816 while she was travelling to meet her brother, called by the governing caliph, the Abbasid al-Ma’mūn, at the time stationed in Marv, who wanted to officialise his designation as supposed heir to the throne. The Imām would follow the caliph, forced to leave Iran in 818; he would die in Iran too, at Ṭūs, poisoned by the caliph himself, according to Shiite tradition. Ṭūs would host the sanctuary of the Imām, the *mashhad*, the ‘place of his martyrdom’, and Mashhad is the current name of the city where his burial place is. Qum is firmly Shiite, as is the Iraqi Karbalā’, also a Shiite island in a context that sees a significant Sunni presence. Karbalā’ is the site of the tomb of the third Imām, al-Ḥusayn, killed in 680 in an uneven battle wanted by the Umayyad caliph Yazīd. This killing – where the caliph purposely spilled the blood of the Prophet that flew in the veins of his grandchild – represented a trauma for the entire *umma*. Qum and Mashhad followed the model of Karbalā’ and, as happened in Karbalā’, they were given a special status, thanks to an extraordinary event that left an apparent, material trace in a defined place – a trace which is constantly revisited. All these three locations were to become, and continue to be, pilgrimage destinations, miracle sites, burials of the faithful; in other words: ‘special places’. How do the discourse on boundaries and that on the Alid diaspora intersect in similar contexts, at least in Iran?

Let’s take Qum as a point of reference. The *Ta’rīkh Qum* by al-Ḥasan ibn Muḥammad ibn al-Ḥasan al-Qummī is a chronicle of the city composed in 988-989, that is in the Seljuk period (cf. Calmard 1971). Its text, lost in the original Arabic, is preserved in the partial Persian version made by Ḥasan ibn ‘Alī ibn Ḥasan ibn ‘Abd al-Malik Qummī in 1403-1404 (*Tārīkh-i Qum* 2006), where a lengthy chapter is devoted to Alid presences – both

Ḥasanid (pp. 541-555) and Ḥusaynid (pp. 555-652) - in the city. Qum appears there to be the primary reference point for the Alid who want to leave Medina and/or Baghdad: the city is a friendly territory and, more important of all, is controlled and controllable as well. The presence of the sanctuary of Fāṭima is also essential in economic terms. The Imami Ḥusaynids, in particular, choose it as their permanent seat or as the base for a sort of colonization of nearby minor localities. In fact, in the Timurid era the entire region around Qum is firmly Imami Shiite. The Ḥasanids, on the other hand, consider it rather a stop along the way to the Caspian lands and, more generally, the oriental regions, especially as long as an Alid power is still alive that professes Zaydism, a form of Shia Islam which is different from Imami Shia.<sup>11</sup> In a broad sense, then, the existence of 'something', be it a sanctuary or a religion-bonded political presence, is discriminative in its choice of territory.<sup>12</sup> That is tantamount to say that the boundaries of a territory are marked in fact by the prevalent religious confession acknowledged on individual and collective terms as the sign of a specific identity. Such a phenomenon, which is typical of the whole Islamic oecumene, is paradigmatic when dealing with the Alids - at least from my perspective -, but only because there the marker defined by their presence is unquestionably apparent.

## 5 Homeland

I resume here what I have already said elsewhere (Scarcia Amoretti 2010): the idea of 'homeland' of the *homo islamicus* does not coincide with the Western one. The homeland (*waṭan*) is the 'place where one was born or lives', a 'space that a nomad tribe claims as its own', the *chez soi* that for the *ṣūfī* can even mean the state reached in his spiritual journey. One is not necessarily tied to that place by birth. Furthermore, 'homeland' can also be the point of arrival of a family or individual diaspora, in particular when one - as is often the case with the Alids - can boast any element of prestige. The house (*bayt* or *dār*), a more circumscribed place - refuge, tent, camp, or house in the real sense - is located within this 'homeland'. It is an individual and collective perception at the same time. In fact, the

11 For a survey of the distribution of Alid presences in Iran in the period under consideration here, see Scarcia Amoretti 2012.

12 When the Safavids took power in Iran (1501) and opted for Imami Shia Islam as the established religion, the country was literally marked by the *imāmzādah*, namely more or less magnificent shrines containing the tombs, real or supposed, of male or female descendants of Shiite Imāms. The power intended thereby to demonstrate that Iran was a Shiite country, that Shia Islam was synonymous with loyalty to the power in question and therefore that a loyal subject must be Shiite - a preview, if not a model, of the present-day situation.

individual recognizes himself in the place or, to put it better, has an awareness of his *individual identity* as a member of a group that, in its turn, is aware of being a cell (*personal identity*) of an all-inclusive entity, be it a tribe, a *ṭarīqa*, a sect, or a corporation (*collective identity*). Belonging to that place, understood as 'homeland', has a certain territorial value, the only one ever to be questioned, even when one does not belong physically to that place anymore, be it because one has emigrated elsewhere, or even because the place where everything started does not exist anymore as such. Such framework, which is at the same time ideological and rooted in a specific place that remains the primary point of reference, reveals itself in traditional onomastics, that is, referring to the ancestors and to the elements – the job or a physical quality or indeed a place – that connote the subject at hand in its relation with the outer world. Today, the necessity or the opportunity to conform with the West almost obliterated what was the norm at the end of the nineteenth century: to know a name implied knowing everything, or almost everything, of the history of that particular individual, including the place which for that person represented the territorial reference point of his identity, and the associated implications.

Our Alids, exactly for their exceptionality, are undoubtedly more conservative, if for no other reason than visibility with regard to the less learned classes. A quick glance at the *Kitāb-i Inqilāb va Shahādat*,<sup>13</sup> a work devoted to the onomastics of the most well-know Alid personalities in the recent history of Iran and Iraq, gives us a last opportunity to reflect on the question of 'boundaries' in the land of Iran. The three Alids who made Shiite history in the past century, the last three *marja'-i taqlīds* (a title that is reserved for the highest Imami religious authorities) are all known by a *nisba*, namely a qualifier that indicates their place of birth (but which could have been the same assigned to their entire family) in the terms mentioned here. In chronological order they are Gulpāyigānī, born in Gulpāyigān (a place south of Iṣfahān); Khū'ī, born in Khū'ī (in Azerbaijan); Khumaynī, born in Khumayn (a place south of Qum). Note that these are Iranic locations: a further evidence, if there were need for any, of the never diminished importance and spread of the Alid presence in the land of Iran.

Here, in any case, the point to be highlighted is the path of the careers of the three above-mentioned characters. This path, if transcribed onto a map, would give the most persuasive demonstration of the validity of the observation of Brauer quoted above – «Muslim geography of the Middle Ages is a linear geography, conceived in terms of a network of lines of communication between cities» –, where the term 'city' designates the

---

13 The book is the eight volume of the series *Ganjīna-yi Dānishmandān*, edited by Shaykh Muḥammad Sharīf Rāzī and published in Qum (s.d.).

centre of attraction, clearly mutable, toward which one converges from the periphery and the term 'network' implies the existence of a logic underlying that specific tangle of lines in a space which is not geographically connoted and variable over time.

In our example, that centre is obviously Najaf (cf. Luizard 1991). But this isn't the point to highlight. The example here shows that in the land of Islam, there persists, albeit between the lines, a complex and articulated concept of the 'boundary' entrusted to the 'person' and to his reference group more than to objective factors, be they natural or ethnic: a boundary, thus, that relies on subjective parameters (which does not mean arbitrary), which, if considered in their significance, would lead to a drastic revision of the reasons behind many conflicts, including the continuously underlying tension between Iran and the Arab world.

## Bibliography

- Ashraf, Ahmad et al. (2006). «Iranian Identity», s.v. [online]. In: *Encyclopaedia Iranica*, vol. 13 (5), pp. 501-530. Available <http://www.iranica-online.org/articles/iranian-identity> (2015-12-01).
- Aubin, Jean (1956). «Deux sayids de Bam au XVe siècle: Contribution à l'histoire de l'Iran Timouride». *Abhandlungen der Geistes- und Sozialwissenschaftlichen Klasse* (Akademie der Wissenschaften und der Literatur) 7, pp. 375-501.
- Babayan, Kathryn; Najmabadi, Afsaneh (eds.) (2008). *Islamicate Sexualities: Translations across Temporal Geographies of Desire*. Cambridge (MA): Harvard University Center for Middle Eastern Studies. Harvard Middle Eastern Monographs 39.
- Bausani, Alessandro (1981). «Le lingue islamiche: interazioni e acculturazioni». In: Bausani, Alessandro; Scarcia Amoretti, Biancamaria (a cura di), *Il mondo islamico tra interazione e acculturazione*. Roma: Ist. di studi islamici, Università degli Studi di Roma, pp. 3-19.
- Bernheimer, Teresa (2012). «Genealogy, marriage and drawing of boundaries among the 'Alids (eight-twelfth centuries)». In: Morimoto, Kazuo (ed.), *Sayyids and Sharifs in Muslim Societies: the Living Links to the Prophet*. London; New York: Routledge.
- Brauer, Ralph W. (1995). «Boundaries and Frontiers in Medieval Muslim Geography». *Transaction of the American Philosophical Society (Held in Philadelphia for Promoting Useful Knowledge)*, 85 (6), pp. 1-73.
- Calasso, Giovanna (2010). «Alla ricerca di *dār al-islām*: Una ricognizione nei testi di giuristi e tradizionalisti, lessicografi, geografi e viaggiatori». *Rivista degli Studi Orientali*, n.s., 83 (1-4), pp. 271-296.
- Calmard, Jean (1971). «Le chiisme imamite en Iran à l'époque seldjoukide, d'après le *Kitāb al-Naqd*». *Le monde iranien et l'Islam*, 1, pp. 43-67.

- Calmard, Jean (1980). «Kum». *Encyclopédie de l'Islam*, vol. 5, pp. 369-363.
- Cereti, Carlo G. (2010). *Iranian Identity in the Course of History*. Roma: IsIAO.
- Elaouani Cherif, Ahmed (1999). «La famille al-'Awān-Sharīf de Qayrawān». In: Scarcia Amoretti, Biancamaria; Bottini, Laura (eds.), *The Role of the Sādāt/ashrāf in Muslim History and Civilization = Proceedings of the International Colloquium* (Rome, 2-4 March 1998). *Oriente Moderno*, n.s., 79 (2), pp. 451-456.
- Enderwitz, Susanne (1997). «Shu'ūbiyya», s.v. *Enciclopédie de l'Islam*, vol. 9, pp. 533-536.
- Feener, Michael; Formichi, Chiara (eds.) (2016). *Shi'ism and Beyond: 'Alid Piety' in Muslim Southeast Asia*. London: I.B. Tauris.
- Hodgson, Marshall G.S. (1974). *The Venture of Islam: Conscience and History in a World Civilization*. Chicago: University of Chicago Press.
- Knysh, Alexander (1999). «I Sādāt nella storia: saggio critico sulla storiografia hadramita». In: Scarcia Amoretti, Biancamaria; Bottini, Laura (eds.), *The Role of the Sādāt/ashrāf in Muslim History and Civilization = Proceedings of the International Colloquium* (Rome, 2-4 March 1998). *Oriente Moderno*, n.s., 79 (2), pp. 501-511.
- Lewis, Bernard (1988). *The Political Language of Islam*. Chicago-London: The University of Chicago Press.
- Luizard, Pierre-Jean (1991). *La formation de l'Irak contemporain: Le rôle politique des ulémas chiïtes à la fin de la domination ottomane et au moment de la création de l'Etat irakien*. Paris: Ed. du CNRS.
- Mauriello, Raffaele (2011). «Descendants of the Family of the Prophet in Contemporary History: a Case Study, the Shī'ī Religious Establishment of Najaf (Iraq)». *Rivista degli Studi Orientali*, n.s., 83, suppl. 1.
- Morimoto, Kazuo (2003). «A Preliminary Study on the Diffusion of the Niqāba al-Ṭālibiyīn: Towards an Understanding of the Early Dispersal of Sayyids». In: Hidemitsu, Kuroki (ed.), *The Influence of Human Mobility in Muslim Societies*. London: Kegan Paul, pp. 3-42.
- Mottahedeh, Roy P. (1976). «The Shu'ūbiyah Controversy and the Social History of Early Islamic Iran». *International Journal of Middle East Studies*, 7, pp. 161-182.
- Scarcia Amoretti, Biancamaria (2005). «Modelli autorevoli: l'Epistola di al-Jāhīz (m. 869) contro i cristiani: Qualche osservazione». *Rivista degli Studi Orientali*, n.s., 78 (3-4), pp. 63-75
- Scarcia Amoretti, Biancamaria (2006). «The Migration of the Ahl Al-bayt to Bukhara in Genealogies' Books: Preliminary Remarks». In: Antonini, Silvia C.; Mirza Akhmedov, D.K. (eds.), *Ancient and Medieval Culture of the Bukhara Oasis: Materials of the Conference Based on the Joint Uzbek-Italian Researches in Archaeology and Islamic Studies* (Bukhara, 26-27 September 2003). Samarcand; Roma: The Institute of Archaeology

- 
- of the Academy of Sciences of the Republic of Uzbekistan; La Sapienza Università di Roma, pp. 74-85.
- Scarcia Amoretti, Biancamaria (2010). «'Nostalgia' del passato: chiave di lettura dell'islam, oggi?». *Rivista degli Studi Orientali*, n.s., 83 (1-4), pp. 237-270.
- Scarcia Amoretti, Biancamaria (2012). «A Historical Atlas on the Alids: a Proposal and a Few Samples». In: Kazuo, Morimoto (ed.), *Sayyids and Sharifs in Muslim Societies: the Living Links to the Prophet*. London; New York: Routledge, pp. 92-122.
- Shaban, Muhammad 'Abd al-Hayy (1970). *The 'Abbāsīd Revolution*. Cambridge: Cambridge University Press.
- Wilkinson, John Craven (1982). «The Early Development of the Ibādī Movement in Baṣra». In: Juynboll, G.H.A. (ed.), *Studies on the First Century of Islamic Society*. Carbondale-Edwardsville: Southern Illinois University Press, pp. 125-144.
- Zappa, Francesco (2004). *L'islamizzazione della lingua bambara in mali tra pubblicistica e letteratura orale*. Pisa; Roma: Ist. Editoriali e Poligrafici Internazionali.





## Borders

Itineraries on the Edges of Iran

edited by Stefano Pellò

# Perceptions and Treatments of the Close Other in Northern Iran

Christian Bromberger  
(Université d'Aix-Marseille, France)

**Abstract** Two different types of treatment of the Other in Northern Iran are briefly discussed here: the inhabitants of Gilān as an object of mockery by the people of the Iranian plateau, and the frequent interfaith marriages between Sunnis and Shias in Talesh. These two types of relationship reflect an interesting and different treatment of the Other, who, even if seen as negative, is still perceived as harmless. The data are grounded on fieldwork done in Northern Iran from the 1970s onwards.

**Keywords** Northern Iran. Gilan. Talesh. Other. Mockery. Interfaith.

The question of the Near Other<sup>1</sup> is a complex one. We wish to differentiate ourselves out of fear of being mistaken for him. Saussure, Freud, and Lévi-Strauss have, each in their own way, conceptualized this process of differentiation; for Saussure, it is 'particularism or parochialism' which opposes the unifying «force of 'intercourse'» (Saussure 1986, p. 204); for Freud, it is the *shibboleth* effect<sup>2</sup> and the 'narcissism of small differences'.<sup>3</sup>

1 The Near Other is the spatial and social neighbour with whom one interacts. This nearness can be close (the neighbouring village), or more distended (the neighbouring region), but it always involves mutual and reciprocal relationships. Such is the case in northern Iran. The inhabitants of Teheran visit the shores of the Caspian Sea, those living in Gilān migrate to Tehran to find work, etc. This immediate relation is connected with the stereotypes of the Near Other; those of the Distant Other (Inuit, Japanese, etc.) have other meanings.

2 Referring to the altercation between the peoples of Gilead and Ephraim, such as recorded in the biblical book of Judges (12:5-6): after defeating the Ephraimites, «the Gileadites seized the fords of the Jordan before the Ephraimites arrived. And when any Ephraimite who escaped said, "Let me cross over," the men of Gilead would say to him, "Are you an Ephraimite?" If he said, "No," then they would say to him, "Then say, 'Shibboleth!'" And he would say, "Sibboleth", for he could not pronounce *it* right. Then they would take him and kill him at the fords of the Jordan».

3 Freud implements and define this concept in three of his works (1957, p. 199; 1955, p. 101 note 1; 1958, pp. 64-65); in the latter, he writes: «It is always possible to unite considerable numbers of men in love towards one another, so long as there are still some remaining as objects for aggressive manifestations. I once interested myself in the peculiar fact that peoples whose territories are adjacent, and are otherwise closely related, are always at

---

### Eurasistica 5

DOI 10.14277/6969-100-3/EUR-5-13

ISBN [ebook] 978-88-6969-100-3 | ISBN [print] 978-88-6969-101-0 | © 2016

«One can now see,» he writes, «that it is a convenient and relatively harmless form of satisfaction for aggressive tendencies» – the word is probably too strong here – «through which cohesion amongst the members of a group is made easier» (Freud 1958, p. 65); in his comparative study of the traditions of the Mandan and Hidatsa Indians, Lévi-Strauss also deals with the functions played by minor differences: «neighborliness requires of the parties that they become alike to a certain extent, while remaining different,» he writes. Then he continues, in flowery language:

if customs of neighboring peoples reveal relations of symmetry, one does not have to look for a cause in a somewhat mysterious laws of nature or mind. This geometrical perfection also sums up in the present mode the innumerable efforts, more or less conscious, accumulated by history, all aiming in the same direction: to reach the threshold, undoubtedly the most profitable to human societies, of a just equilibrium between their unity and their diversity; and to maintain an equal balance between communication, favoring reciprocal illuminations – and absence of communication, also beneficial – since the fragile flowers of difference need half-light in order to exist». (Lévi-Strauss 1983a, pp. 254-255)

In Iran, these fragile flowers of difference abound between the two slopes of the Elburz, which forms a floating cultural boundary between people of different lifestyles. The narcissism of these populations is indeed one of *big* differences. In this respect, dietary habits, whether practical or performative, play an important demarcative role, offering an example of what noted by Todorov.<sup>4</sup> The dietary habits of the populations of the Caspian lowlands, north of the Alborz, and of the Iranian plateau, to the south, show a variety of differences and contrasts, thus providing a fertile soil for mutual denigration. Caspian populations are rice lovers – just a few decades ago they were still eating it at each of the three daily meals (see Map 1); they also love fish, eggs, olives and, to a lesser extent, beef; the diet of the people of the plateau, by contrast, consists of bread, dairy products and, occasionally, mutton.<sup>5</sup>

feud with and ridiculing each other, as, for instance, the Spaniards and the Portuguese, the North and South Germans, the English and the Scotch, and so on. I gave it the name of ‘narcissism in respect of minor differences’».

4 «Alimentary habits are an important element in everyone’s culture, and one of the most resistant there can be» (Todorov 2010, p. 32).

5 Rice consumption, previously a prerogative of the *élites*, has today spread to all classes of Iranian society. Nonetheless, the people from Gilân continue to consume more rice than the people of the plateau, and also cook it differently (see Bromberger 2013, pp. 90-91). A Gilak friend who had frequented Azerbaijani Turks, whose traditional diet is based around bread, said to me recently: «*Shokr-e khodā ke tork nashodim*» (Thank God we are not Turks!).

Among dietary habits, the inhabitants of the Caspian lowlands especially stigmatize their neighbours' predilection for bread, which they regard with alternating amusement and compassion, and sometimes even with repulsion. They give the inhabitants of Teheran the nickname of *dahāngoshād* (wide mouths), because – so they say – they spend their time chewing bread, thus revealing their big teeth. Just a few decades ago, bread was still almost unknown in the Caspian region, and the inhabitants of the plateau were thus called «sad eaters of barley bread», for whom the rice of the Gilān province was an enviable luxury. In the early twentieth century, Rabino and Lafont<sup>6</sup> reported that the consumption of bread was described by Caspian peasants as a punishment which undeserving women and children were threatened with. «The Gilek», they wrote, «does not eat bread, but regards it as an unsuitable food for his constitution, to the extent that an angry husband says to his wife: “Go eat bread and die!”» (Rabino, Lafont 1910, p. 140). Captain Conolly noted around 1830 that Gilak parents, when scolding their children, threatened to send them beyond the mountains where – ultimate punishment – they would be forced to eat bread (cf. Rabino, Lafont 1910, p. 140).<sup>7</sup> Conversely, in the communities of the plateau, numerous proverbs extol the excellence of bread, whose sight, taste and smell, far from causing people to flee, attract them to and keep them in the home. One of them goes: *Nān injā, āb injā, kojā ravam beh az injā?* (Here, there is bread, here there is water, where else would I go?).

Among the foods that delight Caspian peasants, most people of the plateau feel a deep distaste for olives, beef, and fish, to the point that a mere mention of these dishes causes among some a spasm of nausea. I remember that, a long time ago already, during one of my first stays in Gilān, the owner of a coffee shop approached me, looking embarrassed, and asked me if I might accept to eat beef. A strange question for a Frenchman, but not for an Iranian! However, it is the consumption of pond and small marine fish that is particularly stigmatized. All of the soft parts of these fish are eaten: not only the flesh, but also the eggs, whether raw or

Then, he continued: «You know, if I do not eat rice every day, I feel bad». Stereotypes die hard, and only change when new social interactions occur. These changes in stereotypes have been studied on an empirical basis by two social psychologists in an already old article (Prothro, Melikian 1955).

6 Hiacynthe-Louis Rabino di Borgomale was Vice Consul for the United Kingdom in Rasht during the early twentieth century; he wrote several interesting studies on Gilān at that time, as well as on the history of the province. D.F. Lafont was an agronomist who came to Gilān during the same period.

7 On this ancient aversion to bread, see also Fraser (1826, p. 88). This distaste for bread, even the ignorance of this food by peasants, was still felt in the 1980s, particularly in the valleys and plains of southern Tālesh. The map I prepared with the help of Mr. Bazin of rice consumption during the three daily meals in Gilān and its neighbouring regions, clearly shows the dietary boundary between bread and rice eaters.

cooked into a cake with garden herbs; the entrails, which are pan-fried and appreciated for their sweet taste; the heads, whose content is sucked out or which are stewed with herbs. Fish heads can also be eaten with broth, after having pan-fried them in oil in a mixture of garlic and curcuma. It is to this reputation as lovers of fish heads that the Caspian populations (who are called by the name of Rashti, from Rasht, the local capital) owe the nickname which they are called by the people of the plateau; for their neighbours, they are *kallemāhikhor*, 'fish-head eaters'.

'Wide mouths', 'barley bread eaters', 'fish-head eaters', – such disparaging nicknames are part of the vast apparatus of symbolic differentiation which societies use to bring out, through derision and a set of oppositions, their own excellence and superiority. The near Other, especially when it is particularly close,<sup>8</sup> is assimilated to our dietary taboo. This 'gastrophobia' towards 'exocuisine' plays a part, to borrow an expression from Lévi-Strauss, in the «normal functioning of differences» (1983b, p. 15). In short, it is a trivial expression of ethnocentrism.

Dietary habits are not the only register which the inhabitants of the Iranian plateau draw from to disparage their neighbours in the Caspian lowlands. Countless jokes denigrate the behaviour of Rashtis. The reverse is not true: jokes about Tehranis do not exist in Gilān. This asymmetry reflects the inequality of the two peoples' influence in the national space. In Rashti jokes (about Rashtis), the Caspian region seems first and foremost to be a land of morons. But most of these jokes concern the sexual indolence of the men and the frivolity of the women of the province. It is to this reputation that Rashtis owe the second nickname that the people of the plateau give them: *kamarsost* 'the impotent'. A priori these two nicknames relate to two different situations: food and sexuality. However, things are not so simple. Both nicknames (*kallemāhikhor* and *kamarsost*) actually involve the same system of representation wherein various foods and temperaments meet and match. Let us take a closer look.

For many inhabitants of the plateau, the indolence of Rashtis is due to the humidity of the Caspian lowlands. According to the canons of popular customary geography, the physical and sexual abilities of men are, in fact, directly ascribed to the heat and dryness of the climate. Arid areas correspond to manly men and sensual but hard to get women (who, like their climate, are warm and dry); conversely, indolent men and easy women live in cold and wet countries. This popular belief echoes scholarly traditions in Arabo-Persian geography – and, long before that, in Hippocratic geography – which attributed to climate an instrumental role on the virtue of people. The world

---

8 Consider, for example, the case of France, where mocking dietary-related nicknames abound and inhabitants of neighbouring villages are scoffingly called 'snail-eaters', 'potato beetle-eater' and other disgusting names (for southern France, see Achard 1982).

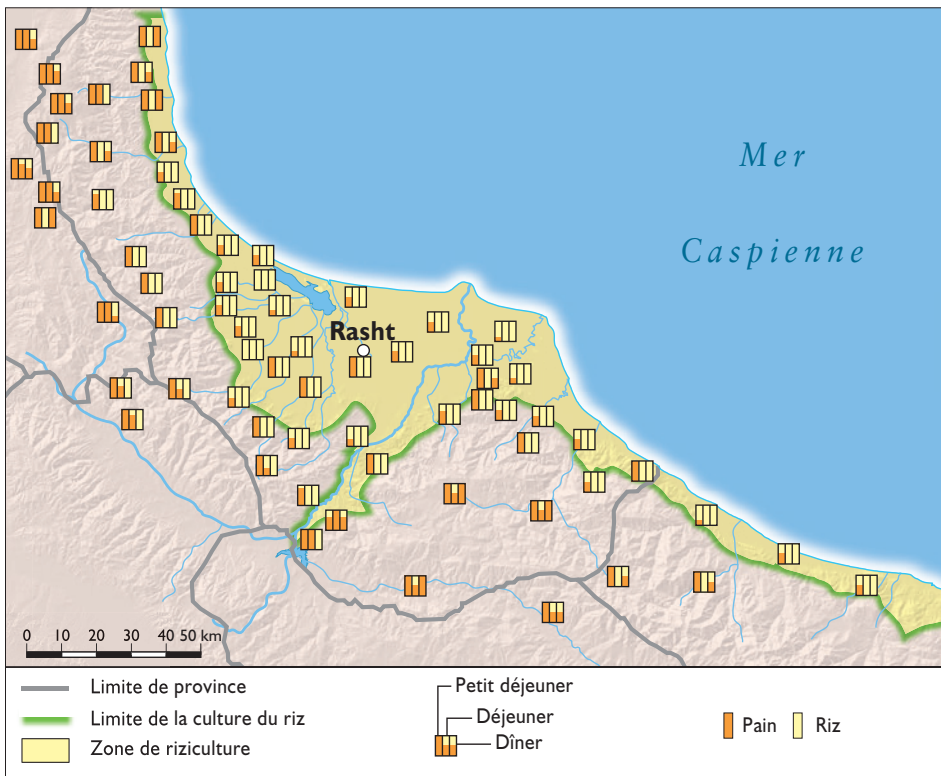

Figure 1. Consumption of bread and rice in the three main meals in the early 1980s (Bromberger 2013)

is divided, according to a tradition that combines Greek and Zoroastrian concepts, into seven regions (*keshvar*) or climates (*iqlim*), organized according to a «starry distribution» (Miquel 1973, p. 70) around a centre formed by the lands extending from Babylon to Khorasan. In this scheme, Gilan belongs to the sixth climate and, according to Mas'udi in his *Prairies d'or* (Meadows of Gold), men from these northern regions have a «cold temperament», «wet principles» and show «little sexual desires» (Mas'udi 1979, p. 518).

This interpretation of ethnic behaviours based on the climate is only a part of a much larger system which represents the world, the beings, and their qualities, and which is organized around two basic categories, namely cold (*sard*) and warm (*garm*), and two sub-categories, namely dry (*khoshk*) and wet (*martub*). Not only climates, foods, sicknesses, seasons, and ages are classified according to these four categories, but also people themselves. According to these qualities, inherited from the humoral medicine of Hippocrates and Galen, individual and collective behaviours are largely dependent on the type of food consumed. Warm foods regenerate that

fundamental humour that is blood, generate an expansive temperament, and maintain strength, power, and virility. Cold foods instead correspond to a phlegmatic temperament, weakness and sexual indolence. According to the classification of foods in Iran, then, the people of the plateau regard those of Gilān as 'eaters of cold'. As mentioned earlier, they consume an abundance of rice, eggs, fish, vegetables and fresh fruits, and like acidic tastes, all of which are considered to be cold.

This feeling of strangeness is strengthened by looking at the extensive differences in lifestyles between people living on different sides of the mountains. For the people of the plateau, Gilān is kind of a topsy-turvy world. I will not give a long list of oppositions. Instead, I will just note, as examples, that Gilān is like a house open to outside gazes and not hidden away inside a walled courtyard; it is a society with a sense of honour and in which violence among individuals and groups occur less than in central Iran; it is, in a sense, feminine and not masculine (male-female relations are far more relaxed than in central Iran but have nothing in common – should it be stressed? – with the content of the jokes). In the representations of the people of the plateau, Gilān appears to be the paradigm of otherness, a situation that often leads to smiles.

Does this vision of the Other have any actual consequences (what might be called stereotypical effects)? There have been some, at some period, but only in a limited way and, after all, perhaps to the benefit of Gilānis. Thus, in the nineteenth and the early twentieth century, the army never recruited much among the peasants of Gilān lowlands, preferring to draw into its ranks mountain dwellers from the highlands, who were reputed to be more robust (Rabino 1915-1916, p. 29). Gilānis have internalized, at least in part, this stereotype, and recognize that some tasks – those involving strength and a spirit of adventure – should be performed by other ethnic groups, who are usually poorer than them (and here is the real difference).

But, to return to the mocking attitudes of the people of the plateau towards the Caspian peasants, they seem to me to reveal, to quote Lévi-Strauss, «inevitable [...] attitudes [...], the price to be paid to preserve a collective self». «We cannot», Lévi-Strauss continues, «blend into an enjoyment of the other, identify ourselves with him, while at the same time remaining different» (1983, p. 47). Here, we are still in the domain of acceptability, where the perception of differences is confined to jokes and, ultimately, offset by a sense of common 'Iranianness'. These frictions are not likely to trigger «cascades» (Rosenau 1990, p. 299) such as might be the case with the Arabs (the invaders of old, perceived by Iranians as savages) or the Afghans (the poor immigrant wretches).

The second example of treatment of the Other that I would like to address is that of 'mixed' marriages in the Tālesh, what I call the 'Tālesh solution'. Tāleshis are an ethnic group based in the north of the Gilān prov-



ince. They are divided more or less equally between Shiites and Sunnis. This religious opposition, when it overlaps with ethnic differences, leads to frictions that can degenerate into confrontations (such as is the case in Baluchistan and Kurdistan). The tension between Shiites and Sunnis is apparent both at the national and governmental level: the education system favours Shiism, there are no Sunni mosques in Tehran and no Sunni ministers in the government. However, the same tension is not visible among Tāleshis. While most villages have two mosques (one Shiite, one Sunni), it is not uncommon for the faithful of both confessions to pray, for reasons of convenience (such as proximity), in the same building and the Shiites with their arms along their bodies, the Sunnis with their arms crossed. Mixed cemeteries are the norm, where Shiite graves are next to Sunni ones. In Tāleshi villages, Shiites avoid celebrating the parodic ritual of the *Omar kushun* «Omar's murder», which is offensive to their Sunni neighbours. Some Sunnis follow the *'āshurā* processions, which are Shiite-specific, but without beating their chests as sign of mourning. Sometimes they also contribute towards the expenses of the meals provided to the penitent. In some cases, places of pilgrimage (*ziyaratgāh*) are common too. Most of all, however, mixed marriages are not uncommon. We know that, in those cases, the main concern of clerics and families is the religious status of the unborn children. Tāleshis have found a unique solution to the problem: the transmission of religious affiliation differs from that of properties and social status; in case of mixed marriages, the boys take up the confession of their father, the girls that of their mother. In other words, the transmission of religious affiliation is governed by a «complementary filiation», (see Meyer Fortes 1953, p. 33), functioning in a bilateral manner. This complementary filiation, which deviates from the dominant patrilineal cultural context, may cause some amusing situations, such as when, for example, a little six-year-old girl said, pouting, to her Sunni father: «*Man, shi'a hastam*» (Me, I am a Shiite). However, there are exceptions to the general rule, which are sometimes linked to a specific context, sometimes to personal 'choices', and sometimes to negotiations, one might say, using a term very much loved by contemporary social sciences.

Ultimately, Tāleshi society gives an example of confessional exogamy (albeit within the same religion) which Western Christians – for whom interfaith marriages between Catholics and Protestants destroyed families until the recent past – as well as Jews and Muslims – for whom marriage with an Other is prohibited if it challenges the transmission of religious affiliation to the children – should take in consideration as a viable solution. Concerned by these prohibitions which, both in the East and in the West, hinder the advent of open societies, in 2008 I saw in Tehran the director of the Institute for Interreligious Dialogue and former Head of the Cabinet to President Mohammad Khatami Mohammad Ali Abtahi, a champion of dialogue among civilizations. This wonderful man was imprisoned after

the protests following the elections of June 2009.<sup>9</sup> As we discussed serious issues such interfaith marriages, Abtahi raised his arms to the sky and told me: «We are dealing here with aspects that bring religions together, not with what divides them». Isn't Tāleshis' pragmatic response to the problems that they face preferable to such general considerations on what might bring religions together? Northern Iran thus shows harmless forms of treatment of the Other which are worthy of reflection in the present-day Middle Eastern context.

## Bibliography

- Achard, Claude (1982). *Les uns et les autres: dictionnaire satirique des sobriquets collectifs de l'Hérault*. Béziers: CIDO.
- Bromberger, Christian (2013). *Un autre Iran: Un ethnologue au Gilân*. Paris: Armand Colin.
- Chodzko, Alexandre (1850). «Le Ghilan ou les marais caspiens». *Nouvelles annales des voyages et des sciences géographiques*, 1, pp. 193-215.
- Fortes, Meyer (1953). «The Structure of Unilineal Descent Groups». *American Anthropologist*, 55 (1), pp. 17-41.
- Fraser, James Baillie (1826). *Travels and Adventures in the Persian Provinces on the Southern Banks of the Caspian Sea*. London: Longman, Rees, Orme and Brown.
- Freud, Sigmund (1955). *Group Psychology and the Analysis of the Ego*. In: *The Standard Edition of the Complete Psychological Works of Sigmund Freud*, vol. 18, pp. 65-144.
- Freud, Sigmund (1957). *The Taboo of Virginity*. In: *The Standard Edition of the Complete Psychological Works of Sigmund Freud*, vol. 11, pp. 191-208.
- Freud, Sigmund (1958). *Civilization and Its Discontents*. Garden City (NY): Doubleday.
- Guilliny, M.-E. (1866). «Essai sur le Ghilan». *Bulletin de la Société de Géographie*, février-mars, pp. 81-104.
- Lévi-Strauss, Claude (1983a). *Structural Anthropology*, vol. 2. Chicago: The University of Chicago Press.
- Lévi-Strauss, Claude (1983b). *Le regard éloigné*. Paris: Plon.
- Mas'udi (1979). *Les prairies d'or*, tome 2. Trad. franç. de Barbier de Meynard et Favet de Courteille. Première éd. 1864, rev. et corr. par C. Pellat. Paris: Société asiatique.

---

<sup>9</sup> Abtahi was given a six-year sentence (after confession!) and was released on bail in November 2009.

- Miquel, André (1973). *La géographie humaine du monde musulman jusqu'au milieu du 11e siècle*, tome 1, *Géographie et géographie humaine dans la littérature arabe des origines à 1050*. Paris-La Haye: Mouton.
- Prothro, E. Terry; Melikian, Levon H. (1955). «Studies in Stereotypes: V. Familiarity and the Kernel of Truth Hypothesis». *The Journal of Social Psychology*, 41, pp. 3-10.
- Rabino, Hiacynthe-Louis (1915-1916). «Les provinces caspiennes de l'Iran: Le Gilân». *Revue du Monde Musulman*, 32.
- Rabino, Hiacynthe-Louis; Lafont, D.-F., (1910). «La culture du riz au Guilân (Perse) et dans les autres provinces du sud de la Caspienne». *Annales de l'École nationale d'agriculture de Montpellier*, 10, pp. 130-164.
- Rosenau James (1990). *Turbulence in World Politics: A Theory of Change and Community*. Princeton: Princeton University Press.
- de Saussure, Ferdinand (1986). *Course in General Linguistics*. Ed. by Charles Balley and Albert Sechehaye with the collaboration of Albert Riedlinger; translated and annotated by Roy Harris. La Salle (IL): Open Court.
- Todorov, Tzvetan (2010). *The Fear of Barbarians: Beyond the Clash of Civilizations*. Cambridge (UK); Malden (MA): Polity Press.



## **7 Mirrors and beyond**



## Borders

Itineraries on the Edges of Iran

edited by Stefano Pellò

## Certified Copy

### The Thin Line between Original and Original

Marco Dalla Gassa

(Università Ca' Foscari Venezia, Italia)

**Abstract** The window and the mirror have often represented, in the history of cinema theories, two different ways to deal with the nature of vision: the first pledging to be the instrument to point to reality and the world, and the second appearing as a magnet, attracting, absorbing and redoubling individual subjectivities. In two short but meaningful sequences of *Copie conforme* (*Certified Copy*) Iranian director Abbas Kiarostami resolves this dicotomy, depriving both objects of their primary function: the window does not show and the mirror does not reflect. Dealing with the theoretical and practical consequences of this choice, which is read through the critical lenses of scholars such as Metz, Deleuze, Eco and Merleau-Ponty, the boundary spaces which separate and unite on-screen and off-screen, filmic and non-filmic, diegetic and non-diegetic, screen and theatre, copy and original are explored, especially when the camera takes the place of the mirror.

**Summary** 1 Two Twin Shots. – 2 Windows, Frames, Mirrors. – 3 Mirror, Mirror on the Wall... – 4 the Absent Mirror. – 5 *Conformed Copy*.

**Keywords** Abbas Kiarostami. Mirrors in Movies. Philosophy and Film. Iranian Cinema.

Les miroirs feraient bien de réfléchir un peu plus avant de nous renvoyer notre image

(Jean Cocteau)

## 1 Two Twin Shots

A woman looks in the mirror and smartens herself up. She is in the bathroom of a restaurant. She puts on lipstick. Then she is distracted by music coming from the little square outside the restaurant. She moves away from the mirror to a closed window behind her and peers through the slits in the shutters, looking at the scene for a moment. With a smile, she returns to gaze at herself anew; she adjusts her hair, chooses which earrings to wear, better defines the contour of her lips, and finally leaves the bathroom (fig. 1). A few hours later, a man looks in the mirror. He is in the bathroom of a hotel room. He turns on the light, turns on the faucet, and washes his

---

### Eurasiatica 5

DOI 10.14277/6969-100-3/EUR-5-14

ISBN [ebook] 978-88-6969-100-3 | ISBN [print] 978-88-6969-101-0 | © 2016

333





Figures 1-2. *Certified Copy*

hands, automated. He is absorbed in his thoughts with an absent stare. The tolling of the bells from a nearby church, a summons to the churchgoers, seems to wake him. The man resumes his self-examination. He fixes his hair with a hand and leaves the bathroom. A slight zoom puts the window behind him in focus: the roofs of the houses and, in the distance, the church tower producing the ringing of the bells. The film credits start to roll (fig. 2).

These are two 'twin' shots from Abbas Kiarostami's *Certified Copy* (*Copie conforme*, 2010). Separated by some twenty minutes, found in the second part of the film, they capture the two main characters – one an antiquarian, the other a writer – in two rare moments of 'solitude', looking themselves in the mirror, perhaps caught off guard in a self-reflective state, in a flash of self-consciousness. Conversely, for the rest of the story, the pair is engaged in continuous dialogue, full of reflections on life, art, and romantic relationships, commemorations of the past, or claims and reciprocal accusations. If



Figures 3-4.  
*The Wind Will  
Carry Us*

one is not pontificating, the other is complaining, asking for reassurance, advancing theories or doubts, or soliciting and goading the partner in a procession of arguments that revolve around the (true or feigned?) crisis in their relationship. In contrast, in the two close-ups described above, it is the silence (or rather the background sounds), and especially the (inward-looking?) looks of the characters, to take the lead role.

The two narrative segments described here are provided elements of 'isolation' by the configurative strategy chosen by Kiarostami, which 'simulates' the presence of the mirror and never puts it in the pro-filmic space, thereby denying the characters 'company' with their own reflections. As can be seen from the frames published here, it is the actors who pretend to look in the mirror, acting as if it were there, when in fact their eyes are evidently facing the lens of the camera (and therefore the viewers). It is a solution that Kiarostami had used before, but of a less schismatic variation. I refer to *The Wind Will Carry Us* (*Bād mā rā Khāhad bord*, 1999) and, more

specifically, to a sequence in which the main character – a photographer from Tehran on a visit to a village in Iranian Kurdistan – shaves himself in the early morning on the balcony of a house. It is a recurring gesture, which the man repeats several times during his stay (and thus which we see represented other times), and which, in one instance, is presented through the point-of-view shot of a small mirror hanging next to the entryway of the house (fig. 3). In that film, however, the mirror appeared in other shots, contributing to an altogether consistent and logical diegetic universe (fig. 4).

In our case, however, as mentioned earlier, a more rigorous solution with more significant theoretical implications is adopted: in the two narrative segments described, no other shots or camera movements are made. We are only permitted to observe the reflected image of the two characters, without ever seeing the mirror that reflects it. I add that another object – of equal speculative importance – makes an appearance in the background of the two shots, once again convened without the ability to fully achieve its scopic function. I speak, of course, of the window that appears in the background of both shots. In the first occurrence it is closed with shutters that do not allow us to see what is happening in the square adjacent to the restaurant. In the second – while showing a glimpse of the roofs of a Tuscan country town – it becomes a kind of framed, neutral surface, above which the end credits roll.

## **2 Windows, Frames, Mirrors**

It takes only a glance through any historical volume on cinema theory to realize that windows, frames, and mirrors are not only common objects that frequently inhabit cinematic diegesis, but are also favoured symbols in the determination of specific prerogatives of the moving image. Thomas Elsaesser and Malte Hagener identify them as among the earliest and most relevant metaphors to have characterized the evolution of discourse on the seventh art, united in the tracing, through an image-concept, of a range of possible relationships between the viewer and the film, and between the film and a certain time period and/or particular theoretical orientation (Elsaesser, Hagener 2015). Echoing the positions of Charles F. Altman (1977), Elsaesser and Hagener affirm that the first two allegorical objects – frame and window – are comparable with one another, despite the disparity in the respective experiences to which each alludes, for at least three reasons: 1) they are models (one constructivist and other realist) which require perceptive practices that are exclusively scopic, leading to a clear distance between seer and seen; 2) they pose the image as a fact and shift the viewer's attention to the film and its structures; 3) they maintain a separation between the experiences of production and reception.

«In other words the cinema as window and frame [...] is ocular-specular (i.e. conditioned by optical access), transitive (one looks at something) and disembodied (the spectator maintains a safe distance)» (Elsaesser, Hagener 2015, p. 15).

If a look into the frame or through the window poses little hermeneutic problems - continue the two Dutch scholars - a look into the mirror determines more questions, because it relies on psychoanalytically based approaches, and begs questions of identity and otherness, recognition, and alienation, in more stringent ways.

A look into the mirror necessitates a confrontation with one's own face as the window to one's own interior self. Yes, this look at oneself in the mirror is also a look from outside, a look that no longer belongs to me, that judges or forgives me, critics or flatters me, but at any rate has become the look of another, or 'the Other'. (Elsaesser, Hagener 2015, pp. 64-65)

For Dudley Andrew too, in his *Concepts in Film Theory*, window and mirror represent two essential metaphors, if one wishes to reconstruct - with any degree of order - discourse on cinema:

In classical film theory two metaphors of the screen had vied for supremacy. André Bazin and the realists championed the notion that the screen was a «window» on the world, implying abundant space and innumerable objects just outside its border. But to Eisenstein, Arnheim, and the formalists, the screen was a frame whose boundaries shaped the images appearing on it. The frame constructed meaning and effects; the window displayed them. [...] Jean Mitry holds that cinema's particular advantage and appeal lies in maintaining the implications of both these metaphors. The cinema is at once a window and a frame. Classical film theory could go no further. Only by shifting the discourse to another plane and invoking another system could modern theory develop. A new metaphor was advanced: the screen was termed a *mirror*. On the force of this coinage, new relations suddenly came to light and were for the first time open to systematic inquiry. Questions about the connections cinema maintains with reality and with art (window and frame, respectively) were subsumed under the consideration of cinema's rapport with the spectator. A new faculty, the unconscious, instantly became a necessary part of any overarching film theory, and a new discourse, psychoanalysis, was called upon to explain what before had been of little consequence, the fact and the force of desire. (Andrew 1984, p. 134)

In other words, in the window/frame and in the mirror two different ways of interpreting the cinematographic apparatus are put in contrast. On one hand, cinema as a vehicle for transparency: a «window open to the world»,

in the Bazinian sense - a real place that emphasizes itself, and an ideal observation space; on the other, cinema as a «mirror for the unconscious», a privileged place of subjectivity, of specularity, of fission and desire, a surface across which the viewer comes to terms with the mechanisms of (non-)recognition, with the image of reflected 'self', and, at the same time, the familiar and inexorably distant image of the 'other'.

Within this apparently aporetic horizon, what do these two shots from *Certified Copy* tell us, and how do they relate to the theme of the double, and the relationship between copy and original, developed over the course of the film, and in this section of the book? Moreover, what are the points of contact between a film that mixes cultures, looks, heteroclitic sensitivity,<sup>1</sup> and the question of otherness and individual/cultural recognition? What role is assumed by the mirror and window, if any, in the dynamics of 'confines', namely, in those procedural places of liminality inhabited by crossings, junctions, no entry borders, checkpoints, and identification protocol? To some of these questions, I will try to offer answers in this essay, after better clarifying the importance of the figure of the mirror in the literature of cinema (and more).<sup>2</sup>

### 3 Mirror, Mirror on the Wall...

The most famous mirror-centred film theories are undoubtedly those of Christian Metz and Jean-Louis Baudry (Metz 1977; Baudry 1970 and 1975). Although they present different nuances and various degrees of intensity, the two French theorists agree that there is a kind of similarity between the experience of the mirror and that of the screen - found on the face of the construction of the scopic subject. In their writings there is a strong focus on cinematographic apparatus - the dark room, the seat, the projector, light beams, the screen - within which the viewer would live out a kind of controlled regression to the so-called «mirror stage» theorized by Jacques Lacan (1966, pp. 793-827). With this noted expression, we refer generally to that stage of the developmental process - between six and eighteen months - in which children begin to construct their own identity, (also) thanks to the ability to look at their own reflection. Still unable to fully manage the movements of their bodies and conceive of themselves as an object autonomous from the mother, children observe themselves in the mirror and, says Lacan, identify themselves, for the first time, as an

1 It is worth mentioning that, even though Kiarostami is an Iranian director, *Certified Copy* was shot in Italy by an Italian crew and produced by a French-Belgian-Italian-Iranian co-production, and its intended audience were cinéphiles and festival goers.

2 For a historical introduction to the significance of the mirror in Western culture, see Melchior-Bonnet 1994.

object in and of itself, thereby projecting a self that is ideal, imaginary, and narcissistic and allows for entrance into symbolic order, and therefore into the surrounding social structures. This same stage, as reinforced by both Metz and Baudry, is relived also by the movie-going audience who, having entered the dark room and sat down in an armchair, relives the same infantile lack of motor capacity, accompanied by marked visual hypertrophy and a narcissistic dimension of recognition of the ideal self.<sup>3</sup> Almost without knowing it, the viewer interacts with the images on the screen with the same ambivalence of disbelief and destabilization that tests the new-born before his or her reflected image of self.

The cinematographic apparatus distances itself, however, from the mirror, due to another equally significant phenomenon: that of removal, delimited more precisely by the writings of Metz. Unlike what happens with the mirror, on the silver screen everything can be reverberated except the face and the body of the viewer in the room. If to Baudry such removal targets a 'phantomization' of the subject and a transparent and idealistic naturalism of the story (especially in Hollywood movies), to Metz it causes a genuine cognitive and psychological misunderstanding, because the cinema spectator believes that he or she recognizes, in a Self, something truly other than self, without registering that the all-seeing, omniscient faculties assigned to him or her lead him or her to a primary identification with the same reproductive apparatus which shares both optical and ideological points of view. Without delving further into theoretical texts of relative interest in this study, it is, in any case, good to preserve their volition to reason – even through the metaphor of the mirror – around certain cultural paradigms. Obviously, I think of the topic of the 'double', on which we will reflect in a moment, but also I think, more generally, of those polarized categories – subjectivity/objectiveness, individual/social, real/illusory, actual/virtual – that find, in specular refraction, a place to interact and negotiate. In other words, psychoanalytic approaches teach us that the mirror is not only an object/metaphor that 'reflects' slices of Self or of the world, but is also a tool that allows one to see the work of some of the models of operation of what exists, while being forced – before a reflective surface – to dissolve contradictions in specular (and social) practice.

The latter position is advocated philosophically by Maurice Merleau-Ponty, who, by virtue of his studies on the phenomenology of perception, often looked into the inferences between apparently irreconcilable dualities, by no accident identifying, in the mirror and in artistic practice, two places privileged with their disambiguation. Endorsing the careful reconstruction of Merleau-Pontyan thought by Pietro Montani (Montani 1999,

3 For other psychoanalytic studies contemporary to Lacan approach devoted to the relations among cinema, mirror, and specularity, see Kristeva (1975) and Mulvey (1975).



pp. 63-80), I'd like to point out that in *The Eye and the Spirit*, for example, the French philosopher argues that the experience of looking in the mirror allows the individual, as in few other everyday instances, a clear understanding of the proximity between the being and the entirety of the world, or to use two of his famous definitions, between one's 'own body' and the 'flesh of the world'. The reason lies in the fact that those who look in the mirror live the exceptional condition of simultaneously 'being seen and seeing', an ego in contact with a me/other-than-self.<sup>4</sup> In *The Invisible and the Visible* he specifies:

I the seer am also visible. What makes the weight, the thickness, the flesh of each colour, of each sound, of each tactile texture, of the present, and of the world is the fact that he who grasps them feels himself emerge from them by a sort of coiling up or redoubling, fundamentally homogeneous with them. He feels that he is the sensible itself coming to itself and that in return the sensible is in his eyes as it were his double or an extension of his own flesh.

Despite having an approach quite distant from the phenomenological one, Gilles Deleuze too identifies a similar dualism that, before the mirror, tends to translate into proximity, or better, «coalescence». In his celebrated *Cinema 2: The Time-Image*, Deleuze entrusts to the mirror the task of configuring what he calls «the crystals of time», or two-faced images in which an actual image and a virtual image coexist and are reconciled. Without ever merging, the two aspects interact in a movement of «mutual presupposition» and «reversibility». According to the French philosopher

there is no virtual which does not become actual in relation to the actual, the latter becoming virtual through the same relation: it is a place and its observe which are totally reversible. [...] The indiscernibility of the real and the imaginary, or of the present and the past, of the actual and the virtual, is definitely not produced in the head or the mind, it is the objective characteristic of certain existing images which are by nature double [...] The most familiar case is the mirror. [...] The mirror-image is virtual in relation to the actual character that the mirror catches, but it is actual in the mirror which now leaves the character with only a virtuality and pushes him back out-of-field. [...] Distinct, but indiscernible, such are the actual and the virtual which are in continual exchange. When

---

<sup>4</sup> In *Eye and Mind* he writes: «Mirrors are instruments of a universal magic that converts things into spectacle, spectacle into things, myself into another, and another into myself. Artists have often mused upon mirrors because beneath this 'mechanical trick' they recognized just as they did in the case of the trick of perspective, the metamorphosis of seeing and seen which defines both our flesh and the painter's vocation» (Merleau-Ponty 1993, p. 130).



the virtual image becomes actual, it is then visible and limpid, ad in the mirror or the solidity of finished crystal. But the actual image becomes virtual in its turn, referred elsewhere, invisible, opaque and shadowy, like a crystal barely dislodged from the earth. The actual-virtual couple thus immediately extends into the opaque-limpid, the expression of their exchange. (Deleuze 1989, p. 69)

For Deleuze there are other objects and conditions of reciprocity - par-amnesia, recollection, the making of an artwork within a film, even ships (Deleuze 1989, pp. 68-97) - that allow the coalescence between actual and virtual manifestation; it is nevertheless indicative, at least here, that it is the mirror to assume, before other elements, a performative specular scope that hosts, without exclusion, ideal and material or, if it better serves, metaphorical and corporeal. And it is cinema, just as painting was for Merleau-Ponty, to be tasked with putting these inferential dynamics to a process.

In this sense, it can be said that the contributions of both Merleau-Ponty and Deleuze confirm - albeit indirectly - the most compelling passages of another renowned essay devoted to mirrors, by Umberto Eco. For the Italian scholar, in fact, before wondering whether the mirror was an object able to illustrate the functioning of semiosis, it was necessary to clear up a big misunderstanding, according to which the refractive object inverts images and reverses them in an expression of inverse symmetry. Contrary to common belief, says Eco, mirrors place reflected objects exactly where they ought to be, with the parts on the right to the right, and the left to the left, and it is due only to the ingenuousness of the observer, who imagines himself in place of the reflected two-dimensional profile, that the perceptive ambiguity can sustain itself continuously.<sup>5</sup> According to this reasoning, which has its philosophical counterpart in the earlier mentioned Deleuze and Merleau-Ponty, the domain of the vision, emotions, and interpretive skills of an observer sets itself against a dynamism easily reconstructible by the laws of physics, and is, in fact, the individual habit and social whole in which the short circuit of sense produced by an object, otherwise peaceful in its behaviour, is realized. Without a subject placed in front and (thereby) mirrored, significant dualities, in other words, could not be produced: the virtual and actual would not form crystallizations, and the exceptional condition of «visible-seer» would not be realized in the absence of an active scopic regime. For Bertetto, this centrality of the gaze relies

5 Eco writes: «A mirror reflects the right side exactly where the right side is, and the same with the left side. It is the observer (so ingenuous even when he is a scientist) who by self-identification imagines he is the man inside the mirror and, looking at himself, realizes he is wearing his watch on his right wrist. But it would be so only if he, the observer I mean, were the one who is inside the mirror (*Je est en autre!*)» (Eco 1984, pp. 205-206).

on the fact that the mirror determines the realization of a «simultaneous and complementary objectivity and subjectivity of identity». The subject

sees himself as he wishes, but simultaneously sees how he appears to the world due to the reduplication of the mirror-camera: he is visible, but in the way a subject is visible to himself, and therefore is seen subjectively in an objective configuration that is invested by the gaze of the subject. It is the subjectivity of the objectivity of a character-subject. (Bertetto 2007, pp. 153-154)

Cinema, in this respect, allows discourse to take a step forward. As with any other visual system, the cinematographic apparatus indeed serves to show us that the look in action is not always merely that of the subject standing before the mirror, but could also belong to a third party observer. There is a group of more recent, exclusively cinematographic studies, which proves the accuracy of this assumption, thanks to the decision to keep issues of symbolic, philosophical, and/or declaratory order in the background, with a focus, instead, on the morphological dynamics that can be triggered with the introduction of a reflective surface to a particular environment. As recalled by Dario Tomasi in a book devoted to the models of representation of some typical dramatic situations, the presence of a mirror in a shot, in fact, offers increasingly «new horizons to cinematic representation [because] it shows more and more of what it might represent without it» (Tomasi 2004, p. 278). In other words, the specular device conveys a surplus of information, not only with respect to character psychology or possible variations of the narrative path, but also to the optical-visual aspect of a film – to its formal configuration. The reason is simple: because shots that contain a mirror always exhibit a part of the diegetic space that, in its absence, would be relegated outside the scene. It follows that its presence induces a multiplication of perspective planes and escape routes, an enrichment of the dynamics between on- and off-camera or even a redefinition of the logic of the construction of the *cadrage*. In their essays on mirrors, Dario Tomasi (2004, pp. 278-324) as well as other scholars such as Antonio Costa,<sup>6</sup> Alessandro Cappabianca (2011), or Paolo Bertetto<sup>7</sup> (to

6 Costa essentially analyses three cases: labyrinthine mirrors, the image *in* the mirror vs. the image *of* the mirror, and the non-existent mirrors (which I will return to later) (Costa 2014, pp. 199-216).

7 Bertetto identifies eight possible specularities: 1) specular images that fill the entire field of vision; 2) images of one or more characters reflected in a mirror that doesn't use up the entire field of vision; 3) images of one or more characters looking their reflection(s) in a mirror; 4) images multiplied by a number of mirrors; 5) images vaguely reflected in a mirror or in some other reflective medium; 6) images in a mirror that you can go through; 7) images reflected in a mirror where the character's reflection is missing; 8) virtual images reflected in an invisible mirror (Bertetto 2007, pp. 134-153).

remain within the manageable scope of Italian literature), analyse various case studies with the objective of highlighting the wide range of expressive possibilities, formal and hermeneutic, offered by reflective surfaces. Unifying these works beyond a certain taxonomist temptation is the decision to select sequences from generally acknowledged masterpieces of cinema history (*Mulholland Drive*, *The Shining*, *Persona*, *Senso*, *Taxi Driver*, *The Lady from Shanghai*, *The Circus*, *Vertigo* and many others) in which the mirror is always found in-frame, and is always shown to the viewer while 'in action', i.e., in the act of refracting the rays of light that hit its surface (characters, rooms, other mirrors, etc.). It is a less obvious and generic lowest common denominator than it might appear at first glance because it indicates, indirectly, how the presence of the mirror is assiduous in movies, not only in its status as an everyday object, but because it triggers scopic dynamics that are often sophisticated, centred around the only person - to recall Metz - that can never be reflected there: the cinema spectator. In other words, the viewer who sits before the screen is the final - and possibly the only - terminus of the phenomena of a shift of the light produced by the cinematographic mirrors - phenomena that, often, would not take on the same expressive 'spectrum' or visual configuration were they seen from other perspective angles or, above all, by other eyes.

The 'specular' sequences that attest to the scopic centrality of the viewer are so numerous that, in the absence of adequate space, we can refer to them only summarily. Consider, as an example, certain sequences in which the mirror reveals some information to the viewer about the storyline, in advance or subsequently to the foresight or knowledge of a character. Moreover, there are cases wherein the movements of the camera or the optical dolly reveal the specular nature of certain images which previously seemed to be 'objective', generating genuine *trompe-l'oeil* effects, but only for those in the theatre, sharing the viewpoint of the camera in motion. Furthermore, there are rarer, though no less emblematic, cases in which the mirror does not reflect the characters or objects adjacent to it, but images that are unlikely (such as invisible characters, fantastic or oneiric images, etc.), deformed (when the mirror is knurled or curved), or virtual (in comedic gags, when a character pretends to be the mirror image of another individual, symmetrically repeating his or her movements). All of these instances deal with visual-narrative situations in which the refractive phenomenon, real or pretended, is freed from the constraints of *mimesis* to become a pure optical effect, capable first and foremost of causing the viewer to feel basic and thymic emotions (and not, therefore, abstract or complex speculations) such as fear, anxiety, enjoyment, and so on.

## 4 The Absent Mirror

This overview of cinema theories and studies devoted to mirrors may help demonstrate why I am so drawn to the two aforesaid shots from *Certified Copy*. First, unlike those analysed in the volumes mentioned above, there is no mirror 'in action' or, rather, there is but it is not seen; we see no refractive surface, we see no reflected images, and we do not perceive any shifting of light. Tempering this with the earlier reported cases, we see that we are dealing with an extreme case of specular 'expressivity' – extreme because it implies the possibility to overturn Tomasi's definition as well as the claims of most studies on the subject. In Kiarostami's film, the mirror offers «new horizons to cinematic representation» not because it shows more, but because it shows less «of what might be represented without it». In fact, in adopting any other mode of representation – with the juxtaposition of shots, camera movements, pairings, scale shots, etc. – we would certainly have seen the bathroom (including the shape of the mirror), the entryway, the furniture, the characters' clothing, and much more. Conversely, in the two static shots, without dialogue or cuts, no information is presented to the viewer to help him understand the plot points, nor any ensured, iconic, sophisticated conformation to the pleasure of his gaze. We can see how unusual the representational strategy is because it succeeds in the difficult undertaking of excluding the mirror from the pro-filmic space (i.e., everything presented in-frame in the course of a film), rendering it a cardinal parallel subject of the diegetic world (i.e., the narrative world in which the characters find themselves). As commonly happens in films by the Iranian director, the fundamental operation through which the viewer can and must relate to the film is that of subtraction (of narrative information, expressive articulation, and perceptive possibilities).<sup>8</sup>

Second, it should be noted that in the two close-ups under examination here, the mirror is not 'trivially' placed out of scene, as sometimes happens, or to the right or left of the shot (usually expected to be seen with a dolly or subsequent take). On the contrary, we observe a genuine substitution of the specular device with the cinematographic apparatus. The rectangular surface of the mirror collimates, in other words, with one created by the 'matte box' of the camera, and this happens not only with regard to its surface, but, above all, inasmuch as its edges are concerned. Thus, the rectangular mirror becomes a liminal space, a border-land, itself appointing, as usually happens to the matte of the camera, the boundaries that separate and unite the in-shot and the off screen, the filmic from the non-filmic, diegetic from non-diegetic, the screen from the theatre, and

---

8 On the 'subtractive' dimension of Kiarostami's cinema see, among others, Elena 2005, Oubiña 2000, Ugenti 2013.

so on. The formal choice seems to contain an implicit theoretical subtext: borders, perimeters, and even frames and 'windows' - note that in Italian the matte box is called *quadrucchio* (lit. 'little square section'), as well as *finestrino* ('little window') - return a significant 'depth' (the 'depth' of the mirror), deeper than the reflected image itself, and not only due to the absence of the latter. We witness the paradox of a reflective object that delegates part of its structural sense to its edges - the parts of the mirror that do not reflect. Those that, at the beginning of essay, I had presented as antithetical theoretical objects become, in configurative practice, perfectly complementary: the mirror is a window (or better, a *finestrino*) and the window is a mirror, enabling a first movement of 'coalescence' (with others to come) by way of hermeneutical consequences that are not irrelevant. Put another way: in *Certified Copy*, window, frame, and mirror are never metaphors for anything (else) - that is, they offer no information that might be read in figurative or metaphorical sense - but are limited to establishing a 'free port' in which refractive and non-refractive coexist, closed window and window open to the world are reconciled, 'own body' and 'flesh of the world' are indistinguishable.

The gaze of the protagonists into the camera/mirror produces further interesting short circuits. It is, at the same time, an inquisitive look, directed (also) to the cinema spectator, who, being statutorily invisible, according to Metz and Baudry, even becomes the convergence point of the eyes, found, as it happens, in place of the mirror. What the viewer sees on the silver screen is thus the image of an actor/character who seems to want to see his own reflection in him. The virtual effect is alienating and paroxysmal. In this way, the identification processes inherent to specular phenomena are overturned: it is not the viewer to recognize himself in his hero, but, conversely, the hero to seek his reflection in the viewer. On the other hand, by ideally looking each other in the eyes, spectator and character would not register any mutual resemblance (excluding the case, albeit interesting, in which the leading actors, Juliette Binoche and William Shimell, find themselves among the audience). Inversely, those at the mirror find themselves irremediably different, at least from a physiognomic perspective. The right side is not where the right side is, nor the left side where the left side is, for the simple fact that there is no right side or left side to be collimated. It seems to me that the consequently activated theoretical horizon, in this case too, is evident: although sharing an extension of the surface as well as a point of view, there is a correlation between mirror and screen only in the recognition of their diversity. It follows that the viewer cannot be (like) the child who recognizes his own image in the mirror/screen, because he himself is the mirror, involved in his role as speculative agent, subject/object/apparatus 'in action'. He finds himself within a mechanism that does not produce doubles, does not generate projections, does not create specularity, and does not bring developmental 'stages' to revival. He simply is.

I support such a hypothesis also being comforted by the fact that, in the two sequences mentioned, a decisive role is played by the performative dimension of the actor. Inasmuch as is the subject on-camera, the viewer too is evidently aware that there is no specular image on the set of the two performers. The woman who puts on the lipstick and earrings – as well as the man fixing his hair – simulates gestures that both would make were they observing their own reflections. They simulate; they do not do it ‘for real’. As Hajnal Kiraly would say, «the protagonists are playing that they are playing» (Kiraly 2012, p. 57). The exhibition of this kind of acting, present not only in these two scenes but at other points in the story as well, takes us back to previous features by Kiarostami. As those who have seen it will remember, the film *Shirin* (2008) consists of a succession of shots dedicated to a group of female spectators attending a performance of *Khosrow and Shirin*, a famous twelfth-century traditional Persian poem written by Nezami Ganjevi. We see them seated next to each other in a kind of cinema (or theatre), shot steadily in close-up, without the ability to see the object of their gaze (the show), of which we hear only the sound. In juxtaposition one *next* to the other (in the pro-filmic space) and one *after* the other (in diegetic time), female characters of *Shirin* are shown in the foreground while they cry, laugh, and are moved to the beats of the actors on scene (figs. 5-7). Europeans viewers may not know it, but the actresses involved in Kiarostami’s project are all stars of Iranian film and television (Mahnaz Afshar, Katayoon Riahi, Hedieh Tehrāni, Leila Hatami, Mahtab Karamati, and many others). They are a group to which only one foreigner is added: French actress Juliette Binoche (fig. 8).

It follows that the acting role-play, in *Shirin* as well as in the two examples from *Certified Copy*, becomes an essential element of the narrative device employed by Kiarostami, although the consequences, in both cases, seem to lead to faraway lands, and not only for a disparity in the number of occurrences. In the first film it is unknown whether the women, as spectators, are moved ‘for real’, or rather, as actresses, play the role of those who are moved in the attendance of a show. The film is presented as a kind of filmofanic documentary, wherein the ‘real’ actors are those who tread – out of frame – the boards. The actresses/spectators, in other words, do not have to do anything but watch the performance of others in their enactment of a drama. Herein lies the ambiguity of their role. In the second case, however, the gestures of the performers target the camera/viewer and are therefore manifestly artificial. I add that in the first case, as said, the actresses do not speak, but recite with their eyes and facial expressions, all but renouncing the instrument of their craft – the voice –, whereas in the second

Juliette Binoche’s way of acting is especially full of mannerism, as she seems to be continuously looking into a mirror, ‘matching’ her face to the





Figures 5-8. *Shirin*

given situation [...]. Her being the only professional actor of the film, this can also be interpreted as a self-reflexive statement about acting or, more specifically, method-acting that still holds very strongly in European and American cinema. She is evidently playing herself as an actress, when, just like a chameleon, she is deliberately changing her well known 'film faces' as well: the Hollywood star, the dramatic actress of European art movies and the almost unrecognizable, everyday face without makeup from Kiarostami's previous film, *Shirin*. (Kiraly 2012, p. 57)

No smaller is the interference created by another formal antithetical choice: if in *Shirin* the women's gaze is directed mainly out of frame, towards the stage,<sup>9</sup> in *Certified Copy* – not only in the two sequences in reference, but also in others – the lines of sight are directed towards the centre of the frame, searching for an invisible viewer, signalling another significant reversal of roles on the scopic level: in *Shirin*, the actresses interpret the audience in attendance of a love story that has been performed time and time again (the one between the Sasanian emperor Khosrow and the Armenian princess Shirin), while in *Certified Copy*, the actors 'are' the protagonists of a love story that has been lived out time and time again.

9 On gaze and close-ups in Kiarostami's *Shirin* see especially Grønstad 2012-2013.



Nevertheless, the two films share the same absence of the mirror, i.e., the absence of the object being viewed, or if it serves, the absence of the double, for those involved in the film, but especially for the viewers. The mirror of the two bathrooms in *Certified Copy* and the stage of *Khosrow and Shirin* are equally virtual objects – conceptual spaces that, far from producing similarity and recognition, determine distances and misunderstandings. For viewers of *Shirin*, ninety-two minutes of close-ups of women may be slow and tiresome, *a fortiori* if presented with the faces of film stars that simulate the emotions they themselves wish to feel, fictionalizing life in the theatre. As for *Certified Copy*, the direct interpellation aims to a reflection that, as we have seen, is in fact impossible, if not only by virtue of that actorliness that feeds the degree of separation between the poles of communication and recognition, rather than diminishing them. And it is no paradox that the greatest possible distance between audience and screen is calculated in devices that produce the greatest possible proximity.

## 5 *Conformed Copy*

Misunderstandings sometimes become the space wherein cultures are explained, compared, and found to be different. Misunderstanding is boundary that takes form. It becomes a neutral zone, a *terrain-vague*, wherein identity, respective identities, can establish themselves, remaining quite separate by precisely a misunderstanding. [...] But misunderstandings also provide a space for explanation. [...] The misunderstanding is, then, a chance for translation – an area in which the incommensurability between persons or cultures has been come to terms with. [...] The management of the misunderstanding has to do [...] with ‘practices’, with expertise in relations, with a cultural ‘knowing’ with respect to other and to otherness, with an art of living and living together in spite of, or indeed because of, the misunderstanding. (La Cecla 1997, pp. 9-10)

The theses of Franco La Cecla, summarily presented in the citation above, offer me some decisive interpretative keys to lead the proposed argument to its conclusion, finally addressing the question of the relationship between ‘copy’ and ‘original’, which we know to be – even from the title – the central theme of Kiarostami’s film. The narrative pretext by which to start this reflection is known: James Miller (the male protagonist) is an English writer who lives in Tuscany and has published an essay entitled *Certified Copy*, devoted to the importance of copies in art history. At the presentation of the Italian translation, among the audience is also a middle-aged antiques dealer who finds a way, after the event, to see the man again and ask him to account for some of the theses presented in the book. These

are not particularly original or articulate theories (in a nutshell, a copy can be more beautiful than its original and is in equal possession of an artistic statute of its own), but they are juxtaposed with a plot that involves, first, a series of wanderings by car through the Tuscan hills where the couple got to know each other and began courting, then, in the middle of its development, an unexpected and original twist that overturns the situation completely. As a result of the misunderstanding of an elderly bartender who mistakes the writer and antiquarian for husband and wife, at a certain point the two relinquish the professional clothing worn until then (also putting an end to the implicit ongoing courtship) to dress as a couple in crisis. In other words, having deliberated aloud on the meaning of a 'certified copy', the two suddenly become the embodiment of a 'certified couple'. This is the most intriguing moment in the film, at least in my opinion. Having become something other than themselves, the two characters begin, in fact, to play out (in feint, but to what extent?) some common dynamics between partners who have come to find themselves in a marital crisis: anger, vindication, reproaches, longings, memories, and above all, mutual misunderstandings. Their behaviour and feelings appear, thus, both trite, having been experienced dozens of times by dozens of couples before them, and original, lived out by the spouses as if they were new, exclusive, and authentic. In a certain sense, one might say with a *calembour* that the two characters demonstrate the originality of a copy of an unoriginal couple.

With this wordplay, the importance of misunderstanding in action can be gathered. Meanwhile, the narrative twist is generated through a misunderstanding – an exchange between people – that nevertheless helps the two characters to intensify their relationship. For all the argument and accusation, the two are brought closer together – they do not turn away. I note further that the Kiarostami's copy of a couple in crisis – just as with false reproductions of original paintings – is not meant to solve old misunderstandings, but generate new ones, above all in those who watch the story detached and from afar, as a viewer. This viewer will continue to wonder whether and to what extent they pretend, whether and how they reproduce dialogues already delivered elsewhere, and whether and how much of their love story can be considered authentic. The misunderstanding that informs the change of pace in the story satisfies, in other words, the need to build new, if unstable, 'spaces of explanation' – in this case not only internal to the couple, but also between the film and viewership.

Coming to the two sequences analysed in this study and examining them with an attentive approach to the productivity of misunderstanding, they might assume one last hermeneutical function to be added to those already identified. In previous paragraphs, I have 'unfolded' the two shots explaining them as extensions that identify the boundaries between the in-shot and the off screen, the screen and the seat of the viewer, diegetic

and non-diegetic space; then, as moments exhibiting acting that tries in vain to reflect itself in the viewer; and finally, as subtractive configurations of environments, narratives, psychological traits, metaphors, and allegories. Now, it seems to me that the close-ups of Juliette Binoche and William Shimell may also be understood as combinations through which the dialectic between original and copy lives – thanks, above all, to the presence/absence of the mirror – a condition of unpredictability that conflicts with the ‘normativity’ of the rest of the story. It seems to me, in fact, that the two ‘own bodies’, without reflections, doubles, or identifies, left alone with themselves before a mirror that does not exist and an audience that is unseen, realize that they are living the fate of the copy, in (temporary) absence of an original. In other words, like a picture whose original is momentarily lost, the two take on a statute of originality, albeit knowing themselves to be a copy of something else – a copy of two actors delivering a performance, a copy of spectators attending a show, a standardized copy of couples in crisis. The originality of the reflected images acquires, to further paraphrase, a temporary condition that may be dissolved at any instant, that is, when the model of reference reappears: the actor in the flesh, a more multi-faceted character, a line of sight that unmask the absence of the mirror and the presence of the film crew.

Awaiting this occurrence, the copy/couple without original becomes the bearer of its own time-limited originality, reason and result of a comparison that has yet to be put in place and then eventually solved through a more or less authenticating act. The misunderstanding – whether potential or actual – becomes a construct that not only creates spaces, but also times for explanation. It tills the dialectical fields, but also reaffirms the limit of their chronological order. The face in the mirror is, from this point of view, an anachronistically ‘plastic’ demonstration of what I am trying to say. It captures a physiognomic conformation, briefly containing its slow and continuous process of transformation. Yet it can never be a certified copy, because meanwhile its original (the face that is reflected), as in a Zeno’s paradox, has undergone, if imperceptible, a morphological change. It is a copy that does not conform, therefore, in an original, if not necessarily authentic, way. Reflections – and in particular those analysed here, as they are deprived of their object – sanction, in other words, that each original is original to the extent that it has its own temporality, more or less limited, more or less inclined to being corrupted. It is a time, however, that is decisive, because, as said ironically by Cocteau, it is what the mirror needs (and in this case, what the viewer needs, who *is* the mirror) to «réfléchir un peu plus avant de nous renvoyer notre image».

## Bibliography

- Altman, Charles F. (1977). «Psychoanalysis and Cinema, the Imaginary Discourse». *Quarterly Review of Film Studies*, 2 (3), pp. 251-272.
- Andrew, Dudley (1984). *Concepts in Film Theory*. New York: Oxford University Press.
- Baudry, Jean-Louis (1970). «Cinéma: Effets idéologiques produits par l'appareil de base». *Cinéthique*, 7-8 (1-8). Engl. trans.: «Ideological Effects of the Basic Cinematographic Apparatus». *Film Quarterly*, 27 (2), 1974-1975, pp. 39-47.
- Baudry, Jean-Louis (1975). «Le Dispositif: approches métapsychologiques de l'impression de réalité». *Communications*, 23, pp. 56-72. Engl. trans.: «The Apparatus: Metapsychological Approaches to the Impression of Reality in Cinema». In: Philip Rosen (ed.), *Narrative, Apparatus, Ideology: A Film Theory Reader*. New York: Columbia University Press, 1986, pp. 299-318.
- Bertetto, Paolo (2007). *Lo specchio e il simulacro: Il cinema nel mondo diventato favola*. Milano, Bompiani.
- Cappabianca, Alessandro (2011). *Trame del fantastico: Riflessi e sogni nel cinema*. Cosenza, Pellegrini.
- Costa, Antonio (2014). *La mela di Cézanne e l'accendino di Hitchcock*. Torino: Einaudi.
- Deleuze, Gilles (1985). *Cinema 2: L'image-temps*. Paris, Minit. Engl. trans.: *Cinema II: The Time-Image*. Minneapolis: University of Minnesota Press, 1989.
- Eco, Umberto (1984). *Semiotics and the Philosophy of Language*. Bloomington (IN): Indiana University Press.
- Elena, Alberto (2005). *The Cinema of Abbas Kiarostami*. London: Saqi.
- Elsaesser, Thomas; Hagener, Malte (2015). *Film Theory: An Introduction Through the Senses*. 2nd ed. New York; London: Routledge.
- Grønstad, Asbjørn (2012-2013). «Abbas Kiarostami's *Shirin* and the Aesthetics of Ethical Intimacy». *Film Criticism*, 37 (2), pp. 22-37.
- Kiraly, Hajnal (2012). «World Cinema Goes to Italy: Abbas Kiarostami's *Certified Copy*». *Acta Universitatis Sapientiae Film & Media Studies*, 5, pp. 55-71.
- Kristeva, Julia (1975). «Ellipse sur la frayeur et la séduction spéculaire». *Communications*, 23, pp. 73-78.
- Lacan, Jacques (1966). «Le stade du miroir comme formateur du Je». En: Lacan, Jacques, *Écrits*. Paris: Seuil, pp. 793-827. Engl. trans.: «The Mirror Phase as Formative of the Function of the 'I'». *New Left Review*, 51, 1968, pp. 71-77.
- La Cecla, Franco (1997). *Il malinteso: Antropologia dell'incontro*. Bari: Laterza.

- Sabine Melchior-Bonnet (1994). *Histoire du miroir*. Paris: Editions Imago.  
Engl. trans.: *The Mirror: A History*. London; New York: Routledge, 2001.
- Merleau-Ponty, Maurice (1961). *L'Œil et l'esprit*. Paris: Gallimard. Engl. trans.: «Eye and Mind». In: Johnson, Galen A.; B. Smith, Michael (eds.), *The Merleau-Ponty Aesthetics Reader: Philosophy and Painting*. Evanston: Northwestern University Press, 1993.
- Merleau-Ponty, Maurice (1964). *Le visible et l'invisible*. Paris: Gallimard.  
Engl. trans.: *The Visible and the Invisible: Followed by Working Notes*. Evanston: Northwestern University Press, 1968.
- Metz, Christian (1977). *Le signifiant imaginaire, Psychanalyse et cinéma*. Paris: Union Générale d'Éditions. Engl. trans.: *The Imaginary Signifier: Psychoanalysis and the Cinema*. Bloomington: Indiana University Press, 1982.
- Montani, Pietro (1999). *L'immaginazione narrativa: Il racconto del cinema oltre i confini dello spazio letterario*. Milano: Guerini e Associati.
- Mulvey, Laura (1975). «Visual Pleasure and Narrative Cinema». *Screen*, 16 (3), pp. 6-18.
- Oubiña, David (2000). «Algunas reflexiones sobre el plano en un film de un cineasta iraní». En: Oubiña, David, *Filmología: ensayos con el cine*. Buenos Aires: Manantial, pp. 175-186.
- Tomasi, Dario (2004). *Lezioni di cinema*. Torino: UTET.
- Ugenti, Elio (2013). «I limiti del visibile nel cinema di Abbas Kiarostami». *Ágalma*, 26.

## Borders

Itineraries on the Edges of Iran

edited by Stefano Pellò

## Crossing Borders

### Iranian Landscapes as Visual Prototypes around the World

Riccardo Zipoli

(Università Ca' Foscari Venezia, Italia)

**Abstract** Some of the typical features of the Iranian landscape are described, together with the ways in which the author came across them on his many journeys in Iran. The presence of the same features in other countries is then described as evidence of the universal nature of some elements of the Iranian landscape which, in this sense, extends outside the current borders. This theory is supported by 50 photos taken in Iran and in other parts of the world. The individual chapters in the article are prefaced by lines from the poetry of Mirzā 'Abdo 'l-Qāder Bidel (1644-1720), meant as an introduction to and evocation of the topics addressed.

**Keywords** Landscape. Iran. Bidel. Photography.

A man wishes to draw the world. Over the years he fills a space with images of provinces, kingdoms, mountains, bays, vessels, islands, fish, houses, tools, stars, horses and people. Just before he dies, he discovers that the patient labyrinth of lines has traced the lineaments of his own face.

Jorge Luis Borges

We are the mirror to mirages of dreams, and there is no way out: the things we are shown always fit our own mode of earthly seeing.

Mirzā 'Abdo 'l-Qāder Bidel

My whole being was lost admiring the images that appeared,  
if I look at myself in the mirror, my reflection is only wonder.

I first went to Iran in 1972, by car from Turkey, with my professor Gianroberto Scarcia. A firsthand knowledge of the country was indispensable

This article is the English version of an essay that has already been published in stand-alone form (*Riflessi di Persia - Reflections of Persia*, Libreria Editrice Cafoscarina; Nazar Art Publications, Venice; Tehran, 2013). The article has been reproduced here courtesy of Libreria Editrice Cafoscarina and Nazar Art Publications.

---

#### Eurasiatica 5

DOI 10.14277/6969-100-3/EUR-5-15

ISBN [ebook] 978-88-6969-100-3 | ISBN [print] 978-88-6969-101-0 | © 2016

preparation for the Persian language and literature courses that I had embarked on at the University of Venice. I was thus happy to receive lessons in the field by travelling far and wide on the Iranian plateau. The complex and long pondered encounter with the physical feel of the country (not only the geography but also the urban world, art and human relations) led to an extraordinary discovery. It was what made me confirm Persian as the linchpin of my studies, shaping my life to come. Of the many lessons I had on that introductory trip I was most deeply impressed by those on the landscape, both because of the novelty of the teaching method and the fascination of the subject. Everyday we would discuss the aesthetic quality and enjoyment of the various areas. But, most importantly, together we observed and I was taught how to look for the most significant scenes.

The infinite ocean of these visions knows no shore,  
here they push out their boats into a sea like a mirror.

Something was made clear to me right from the start on that journey: the kind of landscape we were visiting, studying and enjoying was not only found within the borders of present-day Iran. It also extended into neighbouring countries. The natural continuation of the geography, however, had been violated by modern and often contrived, politically imposed boundaries. I was thus encouraged to see the physical-aesthetic territory as going beyond the state or administrative entities, which was comprehensible also because, although a new acquisition for a neophyte like myself, this geographical truth followed, in a certain way, the logic of history, as recorded in any handbook: Persian culture had expanded (also linguistically) over the centuries to go well beyond the current state set-up. In short, crossing borders in this region was a familiar concept and situation and, far from evoking dangers and threats, suggested superior, more uniform units.

Those bits of dream have gone to the world's four corners,  
and the wonder of the mirror has filled emporia and markets.

In the same context I picked up another new and, this time, not yet fully comprehensible idea. My professor had alluded to the existence of two Iranian landscape 'satrapies' far outside the borders of the country and very distant from each other: the northern satrapy of Iceland and the southern satrapy of Yemen. Following the old Persian tradition, he used the administrative term satrapy to indicate the dependence of those two 'regions' on a central, dominant power. In other words, he implied that Iran had two distant remote provinces arranged according to the typical models of its own land. Only, in this case, the 'empire' was not a political empire but a landscape empire. The theory could certainly not be found in



any textbook and so seeking references to it was pointless. It was simply a very fascinating suggestion but with rather unusual, uncertain tones. What crystallized in my mind was the idea that the landscapes I saw in Iran also had distant appendices and peripheries. I had to discover them and determine their substance and form. I didn't immediately follow up this idea (I only went to Yemen ten years later and to Iceland twenty years later), but it always accompanied me on my subsequent excursions in Iran, which I continued to visit on a regular basis.

On seeing that great beauty, the onlooker's gaze is amazed and embellished: beauty is reflected, and the pattern on the mirror is a weave of blooming petals.

After that experience in 1972, my travels, usually in the company of my professor, were concentrated in Iran for around ten years. It was love at first sight: my first true love for a foreign country, a deep love destined to last over time. Continually revisiting Iran certainly moulded my feeling for the landscape in a very powerful way. The various areas were so different that they satisfied a host of different aesthetic and emotional desires. You find a whole range of environments on the Iranian plateau: dense forests, humid rice paddies, desert plains with oases and palm trees, lake areas with cane thickets and others with brackish water, small groups of trees or isolated trees, rocky mountains, snow-clad in winter, gentle hills with lively colours, grass fields with brightly coloured bushes and flowers, grain fields that are green or golden according to the season, burnt-out expanses with almost surreal tones, and fresh valleys, with streams and trees, enclosed between bare, arid slopes. On my first guided visits, however, I was kept far away from some places in this complex universe. I was warned against landscape iconography considered to be more obvious and banal, and therefore I only made desultory visits to forests, rice paddies, palm trees and rocky mountains. My attention was drawn, on the other hand, to elements and contexts which were less conspicuous and more elusive: paths, solitary plants, clay walls, bushes, coloured lands, water patterns, desert crevices, small donkeys, clouds, some ruins and only an occasional human presence. This was a world made up of a few individual, clear-cut elements, each connected to the others in always evident and unequivocal multiple relationships. The backgrounds containing them were reminiscent of chessboards with only a few pieces left. In this essentialness, simply moving the viewpoint could change both the substance and the logic of the whole. The pictures were made of subjects and perspectives. It was not enough to discover a typical set of elements (for example, a road, low wall and tree). You also had to establish and define a frame with the right relationships between those elements (the horizontal road - to continue with the previous example - parallel and in front of the low wall from which the tree protrudes). Similar kinds of adjustments are necessary for

the success of any view, but in Iran they are absolutely crucial and are a basic factor in observation. Difficult to determine, these minimal shifts produce substantially different scenes. You have to follow a procedure that is similar to the very tricky operation when you search for the right perspective of reflections on a window pane: in this case, too, first you find the basic scene with the reflecting surface and subjects reflected, and then you adjust the vision with small, careful studied movements that give rise to the end result. An equally careful approach is required in observing these landscapes: it is an essential part of the overall aesthetic success.

Wonder is the language telling of the boldness of our secrets,  
whoever is a mirror by instinct and nature will speak with looks.

It is clearly very difficult, if not impossible, to give a good idea of these landscapes in words, i.e. of the colours and forms of the various elements and backgrounds together with all the relations. Any verbal description turns out to be inadequate and, at most, can suggest a general picture without illustrating or conveying properly the values involved. It would be like claiming to try and make someone love a poem by paraphrasing it or by explaining its meaning without reading the original. On the other hand, the translation of a poem is usually considered as a plausible substitute for the source text. For those who can't read the original, this is the only possible means to become acquainted with a foreign poet's work. In the visual field a similar relationship can be established between a landscape and a photograph of it.

My heart becomes inflamed when I think of the ray coming from such beauty,  
it is like a mirror that has the semblance of fire in the presence of the sun.

Taking photographs has always reminded me of translating. In both cases there is an original (the source text/observed scene) which, for the purposes of communicating to others, undergoes an inevitable change (the target text/photographed scene). There are also affinities in the practical choices: just as translation can be literal, free or even creative, so photography also has varying degrees of fidelity to the world represented, ranging from a documentary attitude to completely reworking the image, with all the intermediate degrees of touching up. The result obviously always depends on the skill and sensibility of the translator/photographer, but the quality of the original plays a key role: insignificant texts or scenes are more difficult to render. The parallel between the two activities can even be extended to the possibility of improving on the original or making it worse: according to their greater or lesser flair compared to the poets, translators make versions which can be more or less beautiful than the source texts, just as more or less skilful photographers deliver images

which can be more or less beautiful than the observed scenes. Over and above the final outcome, the set of these common features, however, rests on the presupposition that the translations and photographs are generally acknowledged as two operations capable of reproducing and conveying a copy which corresponds to the original and represents it.

There is no remedy, here dreams and illusions embrace us very tightly: the heart is a mirror, and it cannot relinquish even one single reflection.

Photographs are thus an indispensable tool for documenting one's own convictions about landscape. This notion coincides with one of my inclinations when travelling: exploring and observing the world inevitably drives me to reproduce it in photographs. It's something I can never give up. I have often heard this need expressed by Abbas Kiarostami, again on the subject of Iran. The famous filmmaker's irresistible urge to photograph arises from the desire to share his feelings with others: discovering beauty and not being able to show that beauty is painful for him. His photographs of the Iranian landscapes, in other words, are the expression of an irrepressible need to communicate. He once told me that he regretted not being able to see the world in a rectangular shape, so that he could always be ready for the click of the camera. It was precisely after visiting so much of Kiarostami's Iran that the same need to document my travel experience with photographs took root in me. Indeed, now I find it painful when I come across beautiful views and can't record and share them. The camera has become an indispensable tool for my movements, almost a natural extension of my visual longing and visual faculty. All of this was in keeping with my gradual education about the landscape of the Iranian plateau. Learning how to observe coincided with my learning how to take photographs. As I mentioned above, this state of affairs lasted for around ten years: the time required to develop a specific, well-defined feeling for landscape inextricably bound to the features of the Iranian world as they had been taught to me. Only then did I begin to travel fairly frequently, no longer in the company of my professor, also outside Iran.

No matter where we turn our gaze, we find a mirror,  
but it is only the view of beauty that reveals our traits.

Having absorbed models and categories, I started to wander round the world to search for and photograph them. This was a way of returning to the scholastic theory of the Iranian landscape 'satrapies', whose meaning I was gradually beginning to grasp. But with a difference that had formed over the years: the suggestion that I should look for traces of Iran in other countries had developed into the need to project an interior awareness outwards. I actually began to observe any landscape I encountered in the light

of my new education. This led me to search in all landscapes for the idea that I had constructed in my mind and spirit and which, by then, was no longer necessarily limited to the country that had generated it. I had been visiting Iran so much that a kind of conceptual landscape had become very familiar and I could gradually find it realized in other countries I went to: a single ideal prototype that fitted into multifaceted realities. My seeking matches for this prototype was driven by a mixture of need and pleasure, and observing and studying landscapes began to coincide with the search for an important part of myself. Photographs thus assumed the function of a kind of mirror, evoking the concept of 'equivalence' put forward by Alfred Stieglitz and then, among others, Minor White. They believed that photographs represent the expression of a feeling and that photographed landscapes are inevitably interior landscapes.

Amidst infinite appearances, don't ignore the only essence,  
the mirrors placed in front of us are the fruit of our illusions.

My search was no longer directly inspired by the real nature of a country but by some of its paradigmatic forms. The many years of journeys throughout Iran, filtered in the light of continuous education, had turned into enchanted, essential traces – just as an expanse of brackish water, evaporating in the heat of the sun, leaves behind a few marvellous salt patterns. This testifies to a 'Persianness' that I had become sensitive to in Iran but that had then thoroughly taught me to rediscover its signs also outside Iran. It had taken the form of a universal constant that had soon made me respond only to its call. By binding myself forever to Iran I had, at the same time, created the conditions to free myself from its corporeality. The need for visions that had originated in that land began to be satisfied elsewhere and, paradoxically, I could almost stop going to Iran or begin to travel 'normally' there in search of those same views which I then found in other countries. In a certain sense, the world had become borderless. There had been a kind of landscape globalization: an aesthetic globalization fostered by a country which, in my cultural formation, had become a peaceful, unrivalled exporter of beauty.

No one understands the charmed patterns of the heart,  
the drawings you see in the mirror are not by a painter.

Had I been a painter, I could have painted those visions from the closed space of a room without going round the world. But I am not a painter, and I am dependent on taking photographs. At least as an inevitable starting point. For creative purposes I can, however, resort to the new methods of postproduction photography. In this way I can process the images to satisfy the aesthetic criteria now built into my sensibility. Doing so I attempt to realize a presumptuous aspiration: give a helping hand to nature

to make the best of its potential landscapes when it seems to 'neglect' the quintessence of those places as I perceive it. At most, therefore, I can act as a kind of interpreter striving to complete reality, but certainly not like a real painter. In the case of the photographs presented here, there were very few and low-impact reworkings: some clouds made more rarefied, the line of the horizon lowered, a tree trunk highlighted, a sapling shifted and a few bushes eliminated. These alterations take nothing away from the reality of the places. They are possible variations – at other times and from other viewpoints – to the benefit of the overall suggestive power and uniformity of the proposed images.

If you want to make the phrases in the book of what you see clear, you must wash every single page with the pure wonder of the mirror.

We might define this possibility of integrating photos as an extreme variation of the process of visualization theorized by Ansel Adams in the wake of Edward Weston's thinking: «The term visualization refers to the entire emotional-mental process of creating a photograph, and, as such, it is one of the most important concepts in photography. It includes the ability to anticipate a finished image before making the exposure, so that the procedures employed will contribute to achieving the desired result. This much of the creative process can be practiced and learned, beyond lies the domain of personal vision and insight, the creative 'eye' of the individual, which cannot be taught, only recognized and encouraged» (1980, p. 1). To my mind this is a valid theory, but requires updating in the light of the new 'procedures' possible in postproduction photography. A modern concept of visualization – i.e. still the capacity to envisage the final image in the initial frame – must also include those 'creative' reflections which, whether made on the spot or later, may then be used on the computer, possibly after further revision and honing. At this point the relationship will no longer be between the photographer and reality but between the photographer and photographed reality, with a consequent shift in sensibility. In short, the new technologies offer today's photographer that opportunity for reflection which authoritative artists once considered as significantly absent in photography. On this subject Henri Cartier-Bresson comments: «Of all the means of expression, photography is the only one that fixes a precise instant. We photographers deal in things that are continually vanishing, and, when they have vanished, it's impossible to bring them back to life. We certainly can't touch up the subject: the most we can do is choose from a series of images shot on a reportage. Writers can reflect before words take shape, before putting thoughts on paper; they can thus bring together several elements. There is also a period when their minds 'forget' and their unconscious works on classifying their thoughts. For us photographers, what has gone, has gone for ever. Hence the anxieties and strength of our

profession. We can't rework the story once we're back at the hotel. Our task consists in observing and recording reality in the sketchbook we call a camera without manipulating that reality, neither during the shoot nor in the darkroom. Such tricks are always noticed by anyone with a good eye» (1952, pp. 3-4 of the preface with non-numbered pages). Conditioned by the historical and technical contingencies of the time, these remarks obviously also now need to be updated. Michele Smargiassi is very clear on the subject: «The *awareness* of being able to resort to easy and powerful postproduction tools now alters *a priori* (much more than in the analogical era) the production plan of a photographic image. Right from the beginning, even before an image is captured, the digital photographer's working method includes the possibility of *improvement*. Cartier Bresson's 'decisive moment' can now be reconstructed at will on a monitor. But if this is the case, why go to such lengths to pursue it in the streets?» (2009, p. 41). Thus it is no longer a question of photographing a 'precise instant', as Cartier-Bresson put it in the passage quoted above, but of identifying that instant and then being capable of reproducing it adequately by resorting to all the existing technical means of photographic production and postproduction. In this way portraying that instant or its optimization may be staggered in time and its extempore capture may give way to subsequent processing. Consequently, the photograph becomes the thought-out rendering of an idea representing reality rather than the immediate representation of reality itself. Photographic processing, on the other hand, has always existed and has always been applied, only the new techniques enable us to do it in fast, perfect and sophisticated ways. Are we dealing more today than in the past with illicit artifices? Or, even worse, with downright deception? Perhaps it would be better to speak of a change in the relationship between the photographer and the world. The works of a photographer are no longer simply live attempts, but are extended to the subsequent stage of a new postproduction. In this process the relationship between the onlooker and the photograph becomes more important than that between the photographer and reality: in the final result the public rather than private tones are accentuated. The emphasis is thus different from Cartier-Bresson's photographic gesture seen as the 'sincere' act of capturing a 'decisive moment' to the possible detriment also of the aesthetic quality of the operation. From our point of view, it doesn't matter much if modern software programs can detect digital touching up. That is not the point. Yet again Michele Smargiassi has some enlightening words to say on the subject: «Today is there even one photograph in the media that reaches its audience without any manipulation? Have there ever been any? Antifraud software demonstrates a truth of which our technologically backward mind has already been convinced for some time, i.e. that to a lesser or greater extent all images lie. So now it is simply a question of not being naive and of making the best use possible of the lies» (2010).

The illusory appearance of our earthly existence was concealed amidst veils, thinking about its deep enchantment is a mirror, and it has disclosed the secret.

We might speak of an ideal world superimposed on reality, admitting the possibility for the photographer to transform varied, contingent situations into a single exemplary picture which, most importantly, as mentioned above, must necessarily be verisimilar, in the sense defined for the Italian equivalent 'verosimile' in G. Devoto and G.C. Oli, *Il Dizionario della Lingua Italiana*: «In keeping with the truth so far as to ensure the probability or credibility of an event that even did not happen, that is not documented or not expected». In Aristotle's view, the poet is privileged compared to the historian because he can narrate not what happened but what might have happened, i.e. possible actions according to the laws of verisimilitude. The poet is thus delegated to represent the universal and not the particular, as we can read at the beginning of Chapter Nine in Aristotle's *Poetics*. To respect these principles, you can't run the risk of falsifying the photographed scene through reworkings that give rise to unreal solutions. An excessive or absurd intervention would only attract attention to the intervention itself and its implausibility, preventing or at least impeding other kinds of reflection (a possible theory but far from my intentions in this context). In short, we can reconstruct the verisimilar but we can't go beyond its boundaries. The aim is to make credible reworkings with a low impact in order to improve the enjoyment of the image (as I have tried to do in the collection published here). In other words, you must avoid undermining the laws governing the scene portrayed. The operation, therefore, can only be successfully undertaken by experts who use their technical capacities not to distance the image from reality but, on the contrary, to improve the image's relationship with that paradigmatic reality built up in mind through meticulous daily observations. In this sense I have followed again the lessons of Abbas Kiarostami who, on several occasions, convinced me of the validity of this philosophy of the image which, applied to Iran, we once defined together as a kind of 'ideal realism' This method has been used by various photographers, also in photo-reportages. An authoritative example in this sense are the adjustments made by Eugene Smith both directly during the shoot and in the printing stage. As he says, they are aimed at «a rearrangement for the benefit of reality», and the whole is based on a kind of emblematic and emotional idealisation of the everyday (Mora, Hill 1998, pp. 16, 337-340).

Everywhere you can see the miracle of that splendour,  
doubts and certainties vanish in the mirror's wonder.

In the light of the initial lessons, the first check on this elaborate process took place in the southern 'satrapy' of Yemen. When I got there, however,



I couldn't find landscape situations that completely fitted my purpose. The architecture and specific organization of the area (towers, palaces, terraced gardens) dominated to such an extent that it was difficult to find a perfect likeness with my original models. Although not completely successful, it was an encouraging first attempt. The trip to the second 'satrapy', the northern one of Iceland, also only yielded partial results, due to a different kind of drawback. In this case too I found plausible correspondences in the wide-open spaces, but they were not accompanied by those elements (trees, walls, paths, etc.) required to establish clear affinities with the Iranian world. Over the years I then made some more convincing discoveries (for example, in the United States and Chile), in which the correspondences with the prototypes, both foregrounds and backgrounds, at times reached truly satisfactory levels. The work is still ongoing and the results are proportionate to the amount of research I have done so far. Some other important and promising countries (such as Spain and Australia) still need to be analysed thoroughly and I hope to add them in the near future. For the purposes of further honing my investigations, I decided to establish and explain the state of my work by publishing here a first collection of images. The set has been organized as follows. I chose ten themes from those in the Iran gallery of my old website (<http://old.riccardozipoli.com>; my new website is now online: <http://www.riccardozipoli.com>) and which, therefore, I considered as being typical of that country: roads, bushes, trees, walls, fields, oases, deserts, mountains, clouds and strips. Four themes are more specific (roads, bushes, trees and walls) and four more general (deserts, mountains, clouds and strips), while the remaining two are intermediary (fields and oases). In this way readers will be able to test my theories on different kinds of landscapes. For each theme, first I chose (from the galleries on my website and from my unpublished archive) a photograph of Iran, my model and source of inspiration, which is therefore present ten times in the overall collection. Then I chose another four photographs of four different countries (excluding Iran) for each theme, making a total of fifty images; these countries may be repeated in different series (Chile, for example, is in the roads series and the mountains series). To stress the ideal sense of my work, I decided to specify the geographical origin of individual images and their dates only in a final appendix. Here I simply list the countries with the related number of photos: Canada (1), Chile (7), Cuba (1), England (3), Georgia (1), Iceland (2), Iran (10), Italy (1), Mexico (2), Morocco (1), Oman (3), Portugal (2), South Africa (5), Tunisia (3), United States (7) and Yemen (1). The photographs taken before 2008 are analogical, those after digital.

To understand the hermetic sense of what you say, O Bidel,  
it is sufficient that the mirror fate has given us reflects properly.

This introduction and the following images are interspersed with lines of poetry by Mirzā 'Abdo 'l-Qāder Bidel (1644-1720), the greatest Persian-writing poet of India. His vast, complex output in prose and verse (his poetry alone amounts to around 100,000 lines) has led to him being labelled in various and, at times, contradictory ways: mystic, materialist, surrealist, realist, existentialist, anti-feudalist, baroque, colloquial, highly imaginative, scientific, idealist, pantheist, Neo-Platonist and anti-symbolist. Although still little-known today, his work exercised a great influence above all on the Indian subcontinent but also on Central Asia and on Ottoman Turkey. In Iran, on the other hand, the novelties of his poetics condemned him to long neglect, only interrupted recently. As proof of the difficulties of his style, in Central Asia it is said that one man who interpreted a line of Bidel in seventy different ways was then later contradicted by the poet himself who, having appeared in dream, told him that none of his interpretations was correct. Bidel's obscurity of expression, an extreme variant of the so-called Indian style, means that – albeit with due caution – it is plausible and certainly suggestive to set his name beside the twentieth-century Italian 'Hermetic' poets. In fact, beyond the evident differences, we find a number of fascinating correspondences that contribute to making Bidel one of the classic Persian authors nearest to modern Western readers' sensibility. From the historical point of view, both the Indian style and the Italian Hermetic style broke with the poetry of the past. Reserved for and only comprehensible to a few, their complex codes gave rise to two kinds of aristocratic, intricate verse in open contrast with the clarity of the classical texts. This led to both movements being harshly criticized by contemporary critics. As regards the mode of inspiration, the Indian school and the Hermetic poets are strongly focused on the interior world and existential reflection aimed at forging poetry as a new reality to be projected on the external world. Indeed no attempt is made at an objective description of reality, which both schools strive to go beyond (with due distinctions: the 'estrangement' in one case is mystical, while in the other it is historical). In this context, in both the Indian school and the Hermetic poets a mood of expectancy and detachment tends to dominate. For the Hermetic poets, however, this mood is a sign of rejection, while the Indian poets describe it as a special 'wonder' propaedeutic to beholding the truth in a sense reminiscent of that wonder understood as the mystical way out of self and as the basis of the philosophical knowledge so well described by Pavel Florensky in his *Dialektika*. But what interests us most here is the common stylistic tendency to 'obscurity'. The main drive in both cases seems to come from an inventive force enabling poets to juxtapose objects and situations without any obvious links in order to forge original relations

and concatenations. Here I'm thinking not only of metaphors, similes and analogies but also synaesthetic language. As Giuseppe Ungaretti once remarked: «Today's poet will thus strive to juxtapose distant images with no linking threads» (1974, p. 760). In both worlds this evocative power is highlighted by concision: the independence of the lines and, in some cases, of the hemistiches in the Indian style corresponds to the brevity of Hermetic poets' 'illuminating' expressions. This reveals a great interest in content rather than in formal perfection. We must also remember the importance of some shared linguistic choices, such as the personification of concepts and the use of abstract nouns in the plural. There is, however, one substantial difference between the two styles: understanding the texts is possible in the Persian case through thinking based on an in-depth knowledge of the motifs and procedures of the tradition, whereas in the Italian case comprehension requires intuition and sensibility. Bidel, as mentioned above, is the extreme exponent of the Indian style and also because of that style's modern connotations, he is my favourite Persian author. I find the lines of verse dedicated to the mirror in his ghazals particularly fascinating. For years I have been working on these lines in which his inventive flair reaches great heights, and every time I have to choose some Persian poetry to be translated I am inevitably attracted to them. And that is what happened this time too. Consequently, the lines published here all contain the word 'mirror'. In this case the occasion was congenial because the theme being dealt with focused on our capacity to observe and distinguish between models and replicas - between the uniqueness of a vision and its multiple reflections. Choosing the verses was far from easy. Bidel can attribute even opposite meanings to the same subject and action according to the theory he is exploring at the time. Given my illustrative purpose here, I decided to overlook this stylistic tendency and selected fairly uniform lines with the emphasis on univocal messages, rather than attempt to show the complexity of the expressive universe. I have made a few adaptations, including always translating the poet's interlocutor (the 'Beloved') in the third person so as to establish more easily a suggestive association with the landscape. In this introduction, the lines of verse are meant as titles for the individual paragraphs, and in the collection of images they mark the beginning of each of the ten thematic sections. The texts of Bidel are from the first volume of the edition published in Kabul (1962-1966). The page numbers in that edition for the verses translated here are as follows. Epigraph: 94; Introduction: 1108, 20, 14, 82, 481, 260, 93, 182, 33, 308, 82, 386, 14, 41, 531; images: 315, 456, 305, 880, 14, 1027, 1111, 1116, 158, 185.

Wonder enchains us and there is no escape,  
wherever you look, you're faced with a mirror.

The first quotation from Bidel, used in the epigraph, is preceded by the translation of a passage on a similar topic from *El Hacedor* by Borges (2005, p. 248). Like Bidel, Borges includes the mirror among the most important objects in his poetic thinking. I feel that Bidel and Borges, two equally complex and, at times, contradictory personalities, with their poly-semantic labyrinths, albeit with obvious differences, would have enjoyed each other's company. The Argentinean author's work has many references to the Islamic world and he even mentions some classic authors of Persian poetry. In this context, it is particularly interesting to note Borges admiration for the mystic parable of the *Manteq ot-Teyr* by Farid od-din 'Attār (died circa 1221). The parable ends with thirty birds (in Persian *si morgh*) seeing their own image reflected, also linguistically, in the Simorgh, the fabulous mythical bird that the thirty birds sought and whose function, in this case, can be compared to that of a mirror. This theme links up with the two initial quotes.

## Bibliography

- Adams, Ansel (1980). *The Camera*. Boston: New York Graphic Society.
- Bidel, Mirzā 'Abdo 'l-Qāder (1962-1966). *Kolliyyāt-e Bidel*. Ed. by Xalil Xalili. 4 vols. Kabul: da Pahane wezārat, da Dār al-ta'lif riyāsat, 1341-1344.
- Borges, Jorge Luis (2005). *Obras completas*, vol. 2, 1952-1972. Buenos Aires: Emecé Editores.
- Cartier-Bresson, Henri (1952). *Images à la sauvette*. Paris: Éditions Verve.
- Mora, Gilles; Hill, John. T. (1998). *W. Eugene Smith, Du côté de l'ombre*. Paris: Seuil.
- Smargiassi, Michele (2009). *Un'autentica bugia: la fotografia, il vero, il falso*. Roma: Contrasto.
- Smargiassi, Michele (2010). «Corazze e proiettili» [online]. *la Repubblica.it, Fotocrazia*, 23 January. Available at <http://smargiassi-michele.blogautore.repubblica.it/2010/01/23/corazze-e-proiettili/> (2014-07-19).
- Ungaretti, Giuseppe (1974). *Vita d'un uomo: Saggi e interventi*. Milano: Mondadori.





I find myself at every step I take to reach my longed-for aim,  
the love I feel has made my road a dazzling set of mirrors.













The multiple world is a true amulet and protects the supreme One's value,  
the plants are a mirror that faces the strength shown by every single seed.













The beloved image and no other image lies pleasantly in my heart,  
the mirror is where wonder dwells and certainly not reflections.











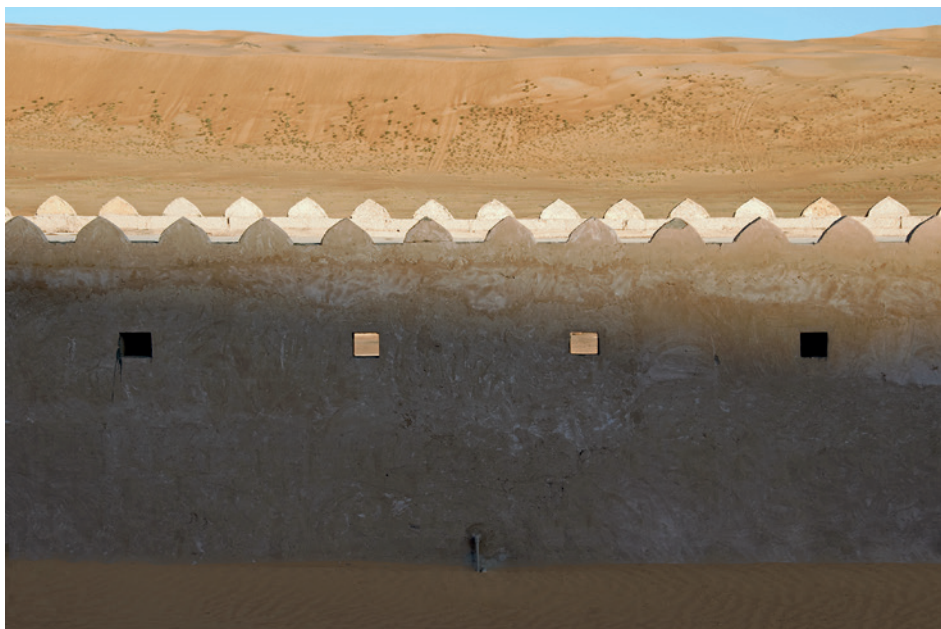

That sun shines and with its blinding light cancels out the reflections in the mirror as with shadows on walls.













All we have harvested in the world's fields is wonder,  
mirrors will sprout if a seed is sown by wise looks.











Of every vision the mirror shows only a simple reflection,  
no painter knows how to make a drawing of the human soul.















We are dust risen from our reflections but the weight of dreams will keep us, like wonder itself, bound to the mirror for ever.

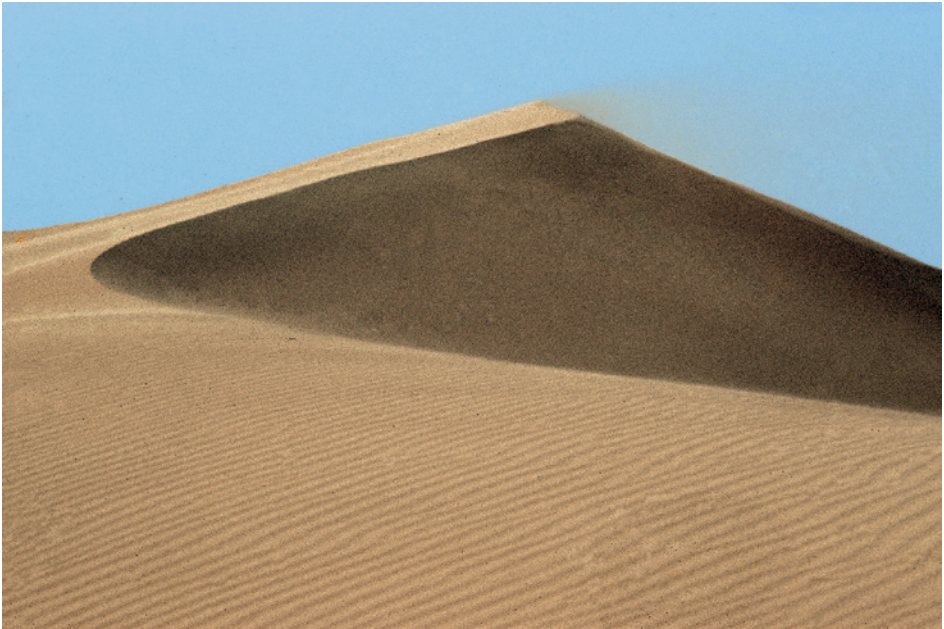

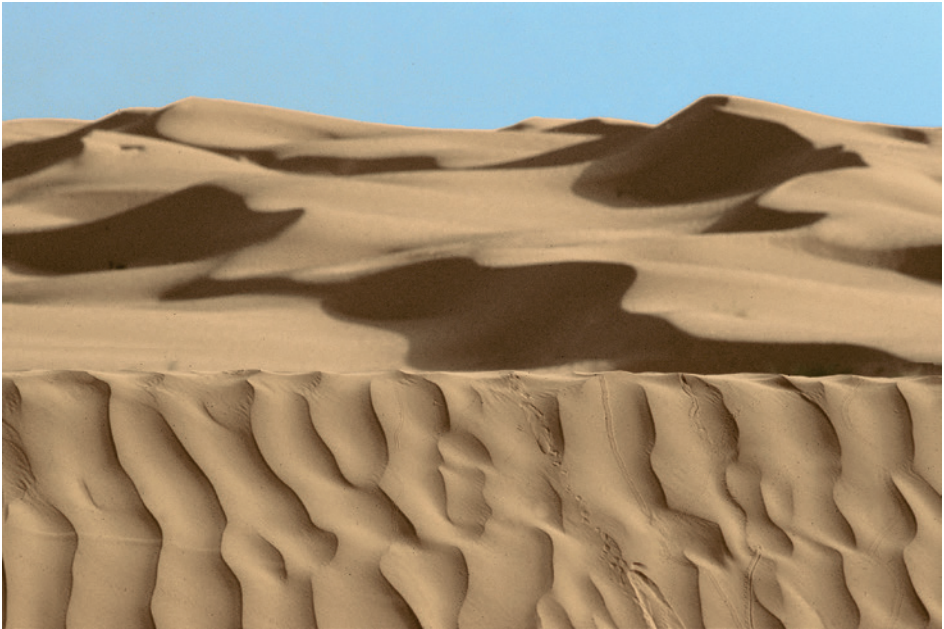







No image appears still and firmly in a conscious heart,  
even the reflections of the mountains move in the mirror.













The scattered dust of many illusions has long been raised in storms,  
here the source of the mirror is a wave that is made only of mirages.











I fail to comprehend the patterns of this illusory world,  
I know that false it appears in the mirror and vanishes.

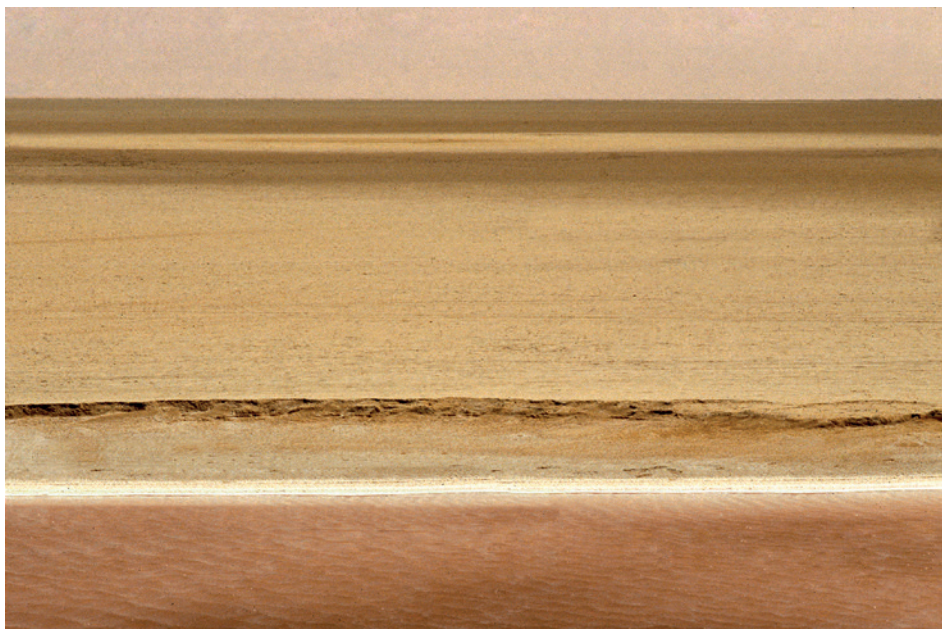







places and dates



**Roads** p. 367

Morocco 2003

Chile 2008

United States 2009

Oman 2010

Iran 2001

**Bushes** p. 371

Portugal 1980

South Africa 2005

United States 2009

Iran 2008

England 1998

**Trees** p. 375

Tunisia 2006

Portugal 1980

South Africa 2005

United States 2009

Iran 2008

**Walls** p. 379

Oman 2010

Yemen 1982

Iran 1975

Chile 2008

United States 2009

**Fields** p. 383

Iran 2008

South Africa 2005

Canada 2005

England 1998

Cuba 2004

**Oases** p. 387

Chile 2008

United States 2009

Mexico 2007

Georgia 1989

Iran 2004

**Deserts** p. 391

Oman 2010

South Africa 2005

Tunisia 2006

Iran 1972

Chile 2008

**Mountains** p. 395

Iran 1975

Chile 2008

United States 2009

England 1998

Iceland 1993

**Clouds** p. 399

Italy 2005

United States 2009

Iran 1980

Chile 2008

Iceland 1993

**Strips** p. 403

South Africa 2005

Tunisia 2006

Mexico 2007

Chile 2008

Iran 2004

This collection of essays stands as the first volume of the new Eurasiatica series entirely devoted to the vast territories of Iranian culture, understood in the widest sense possible and in an open chronological perspective. Explicitly refusing any fetishization of particularism, it contains fourteen studies organized in thematic pairs: a sequence of interrelated itineraries exploring several heterogeneous borderlands – from Avestan philology to film studies – starting from plural, competing and coexisting ideas of Iran.



Università  
Ca'Foscari  
Venezia

